

Network Working Group  
Request for Comments: 2328  
STD: 54  
Obsoletes: 2178  
Category: Standards Track

J. Moy  
Ascend Communications, Inc.  
April 1998

## OSPF Version 2

### Status of this Memo

This document specifies an Internet standards track protocol for the Internet community, and requests discussion and suggestions for improvements. Please refer to the current edition of the "Internet Official Protocol Standards" (STD 1) for the standardization state and status of this protocol. Distribution of this memo is unlimited.

### Copyright Notice

Copyright (C) The Internet Society (1998). All Rights Reserved.

### Abstract

This memo documents version 2 of the OSPF protocol. OSPF is a link-state routing protocol. It is designed to be run internal to a single Autonomous System. Each OSPF router maintains an identical database describing the Autonomous System's topology. From this database, a routing table is calculated by constructing a shortest-path tree.

OSPF recalculates routes quickly in the face of topological changes, utilizing a minimum of routing protocol traffic. OSPF provides support for equal-cost multipath. An area routing capability is provided, enabling an additional level of routing protection and a reduction in routing protocol traffic. In addition, all OSPF routing protocol exchanges are authenticated.

The differences between this memo and RFC 2178 are explained in Appendix G. All differences are backward-compatible in nature.

Implementations of this memo and of RFCs 2178, 1583, and 1247 will interoperate.

Please send comments to [ospf@gated.cornell.edu](mailto:ospf@gated.cornell.edu).

## Table of Contents

1	Introduction .....	6
1.1	Protocol Overview .....	6
1.2	Definitions of commonly used terms .....	8
1.3	Brief history of link-state routing technology .....	11
1.4	Organization of this document .....	12
1.5	Acknowledgments .....	12
2	The link-state database: organization and calculations	13
2.1	Representation of routers and networks .....	13
2.1.1	Representation of non-broadcast networks .....	15
2.1.2	An example link-state database .....	18
2.2	The shortest-path tree .....	21
2.3	Use of external routing information .....	23
2.4	Equal-cost multipath .....	26
3	Splitting the AS into Areas .....	26
3.1	The backbone of the Autonomous System .....	27
3.2	Inter-area routing .....	27
3.3	Classification of routers .....	28
3.4	A sample area configuration .....	29
3.5	IP subnetting support .....	35
3.6	Supporting stub areas .....	37
3.7	Partitions of areas .....	38
4	Functional Summary .....	40
4.1	Inter-area routing .....	41
4.2	AS external routes .....	41
4.3	Routing protocol packets .....	42
4.4	Basic implementation requirements .....	43
4.5	Optional OSPF capabilities .....	46
5	Protocol data structures .....	47
6	The Area Data Structure .....	49
7	Bringing Up Adjacencies .....	52
7.1	The Hello Protocol .....	52
7.2	The Synchronization of Databases .....	53
7.3	The Designated Router .....	54
7.4	The Backup Designated Router .....	56
7.5	The graph of adjacencies .....	56

8	Protocol Packet Processing .....	58
8.1	Sending protocol packets .....	58
8.2	Receiving protocol packets .....	61
9	The Interface Data Structure .....	63
9.1	Interface states .....	67
9.2	Events causing interface state changes .....	70
9.3	The Interface state machine .....	72
9.4	Electing the Designated Router .....	75
9.5	Sending Hello packets .....	77
9.5.1	Sending Hello packets on NBMA networks .....	79
10	The Neighbor Data Structure .....	80
10.1	Neighbor states .....	83
10.2	Events causing neighbor state changes .....	87
10.3	The Neighbor state machine .....	89
10.4	Whether to become adjacent .....	95
10.5	Receiving Hello Packets .....	96
10.6	Receiving Database Description Packets .....	99
10.7	Receiving Link State Request Packets .....	102
10.8	Sending Database Description Packets .....	103
10.9	Sending Link State Request Packets .....	104
10.10	An Example .....	105
11	The Routing Table Structure .....	107
11.1	Routing table lookup .....	111
11.2	Sample routing table, without areas .....	111
11.3	Sample routing table, with areas .....	112
12	Link State Advertisements (LSAs) .....	115
12.1	The LSA Header .....	116
12.1.1	LS age .....	116
12.1.2	Options .....	117
12.1.3	LS type .....	117
12.1.4	Link State ID .....	117
12.1.5	Advertising Router .....	119
12.1.6	LS sequence number .....	120
12.1.7	LS checksum .....	121
12.2	The link state database .....	121
12.3	Representation of TOS .....	122
12.4	Originating LSAs .....	123
12.4.1	Router-LSAs .....	126
12.4.1.1	Describing point-to-point interfaces .....	130
12.4.1.2	Describing broadcast and NBMA interfaces .....	130
12.4.1.3	Describing virtual links .....	131
12.4.1.4	Describing Point-to-MultiPoint interfaces .....	131

12.4.1.5	Examples of router-LSAs .....	132
12.4.2	Network-LSAs .....	133
12.4.2.1	Examples of network-LSAs .....	134
12.4.3	Summary-LSAs .....	135
12.4.3.1	Originating summary-LSAs into stub areas .....	137
12.4.3.2	Examples of summary-LSAs .....	138
12.4.4	AS-external-LSAs .....	139
12.4.4.1	Examples of AS-external-LSAs .....	140
13	The Flooding Procedure .....	143
13.1	Determining which LSA is newer .....	146
13.2	Installing LSAs in the database .....	147
13.3	Next step in the flooding procedure .....	148
13.4	Receiving self-originated LSAs .....	151
13.5	Sending Link State Acknowledgment packets .....	152
13.6	Retransmitting LSAs .....	154
13.7	Receiving link state acknowledgments .....	155
14	Aging The Link State Database .....	156
14.1	Premature aging of LSAs .....	157
15	Virtual Links .....	158
16	Calculation of the routing table .....	160
16.1	Calculating the shortest-path tree for an area .....	161
16.1.1	The next hop calculation .....	167
16.2	Calculating the inter-area routes .....	178
16.3	Examining transit areas' summary-LSAs .....	170
16.4	Calculating AS external routes .....	173
16.4.1	External path preferences .....	175
16.5	Incremental updates -- summary-LSAs .....	175
16.6	Incremental updates -- AS-external-LSAs .....	177
16.7	Events generated as a result of routing table changes	177
16.8	Equal-cost multipath .....	178
	Footnotes .....	179
	References .....	183
A	OSPF data formats .....	185
A.1	Encapsulation of OSPF packets .....	185
A.2	The Options field .....	187
A.3	OSPF Packet Formats .....	189
A.3.1	The OSPF packet header .....	190
A.3.2	The Hello packet .....	193
A.3.3	The Database Description packet .....	195
A.3.4	The Link State Request packet .....	197
A.3.5	The Link State Update packet .....	199
A.3.6	The Link State Acknowledgment packet .....	201

A.4	LSA formats .....	203
A.4.1	The LSA header .....	204
A.4.2	Router-LSAs .....	206
A.4.3	Network-LSAs .....	210
A.4.4	Summary-LSAs .....	212
A.4.5	AS-external-LSAs .....	214
B	Architectural Constants .....	217
C	Configurable Constants .....	219
C.1	Global parameters .....	219
C.2	Area parameters .....	220
C.3	Router interface parameters .....	221
C.4	Virtual link parameters .....	224
C.5	NBMA network parameters .....	224
C.6	Point-to-MultiPoint network parameters .....	225
C.7	Host route parameters .....	226
D	Authentication .....	227
D.1	Null authentication .....	227
D.2	Simple password authentication .....	228
D.3	Cryptographic authentication .....	228
D.4	Message generation .....	231
D.4.1	Generating Null authentication .....	231
D.4.2	Generating Simple password authentication .....	232
D.4.3	Generating Cryptographic authentication .....	232
D.5	Message verification .....	234
D.5.1	Verifying Null authentication .....	234
D.5.2	Verifying Simple password authentication .....	234
D.5.3	Verifying Cryptographic authentication .....	235
E	An algorithm for assigning Link State IDs .....	236
F	Multiple interfaces to the same network/subnet .....	239
G	Differences from RFC 2178 .....	240
G.1	Flooding modifications .....	240
G.2	Changes to external path preferences .....	241
G.3	Incomplete resolution of virtual next hops .....	241
G.4	Routing table lookup .....	241
	Security Considerations .....	243
	Author's Address .....	243
	Full Copyright Statement .....	244

## 1. Introduction

This document is a specification of the Open Shortest Path First (OSPF) TCP/IP internet routing protocol. OSPF is classified as an Interior Gateway Protocol (IGP). This means that it distributes routing information between routers belonging to a single Autonomous System. The OSPF protocol is based on link-state or SPF technology. This is a departure from the Bellman-Ford base used by traditional TCP/IP internet routing protocols.

The OSPF protocol was developed by the OSPF working group of the Internet Engineering Task Force. It has been designed expressly for the TCP/IP internet environment, including explicit support for CIDR and the tagging of externally-derived routing information. OSPF also provides for the authentication of routing updates, and utilizes IP multicast when sending/receiving the updates. In addition, much work has been done to produce a protocol that responds quickly to topology changes, yet involves small amounts of routing protocol traffic.

### 1.1. Protocol overview

OSPF routes IP packets based solely on the destination IP address found in the IP packet header. IP packets are routed "as is" -- they are not encapsulated in any further protocol headers as they transit the Autonomous System. OSPF is a dynamic routing protocol. It quickly detects topological changes in the AS (such as router interface failures) and calculates new loop-free routes after a period of convergence. This period of convergence is short and involves a minimum of routing traffic.

In a link-state routing protocol, each router maintains a database describing the Autonomous System's topology. This database is referred to as the link-state database. Each participating router has an identical database. Each individual piece of this database is a particular router's local state (e.g., the router's usable interfaces and reachable neighbors). The router distributes its local state throughout the Autonomous System by flooding.

All routers run the exact same algorithm, in parallel. From the link-state database, each router constructs a tree of shortest paths with itself as root. This shortest-path tree gives the route to each destination in the Autonomous System. Externally derived routing information appears on the tree as leaves.

When several equal-cost routes to a destination exist, traffic is distributed equally among them. The cost of a route is described by a single dimensionless metric.

OSPF allows sets of networks to be grouped together. Such a grouping is called an area. The topology of an area is hidden from the rest of the Autonomous System. This information hiding enables a significant reduction in routing traffic. Also, routing within the area is determined only by the area's own topology, lending the area protection from bad routing data. An area is a generalization of an IP subnetted network.

OSPF enables the flexible configuration of IP subnets. Each route distributed by OSPF has a destination and mask. Two different subnets of the same IP network number may have different sizes (i.e., different masks). This is commonly referred to as variable length subnetting. A packet is routed to the best (i.e., longest or most specific) match. Host routes are considered to be subnets whose masks are "all ones" (0xffffffff).

All OSPF protocol exchanges are authenticated. This means that only trusted routers can participate in the Autonomous System's routing. A variety of authentication schemes can be used; in fact, separate authentication schemes can be configured for each IP subnet.

Externally derived routing data (e.g., routes learned from an Exterior Gateway Protocol such as BGP; see [Ref23]) is advertised throughout the Autonomous System. This externally derived data is kept separate from the OSPF protocol's link state data. Each external route can also be tagged by the advertising router, enabling the passing of additional information between routers on the boundary of the Autonomous System.

## 1.2. Definitions of commonly used terms

This section provides definitions for terms that have a specific meaning to the OSPF protocol and that are used throughout the text. The reader unfamiliar with the Internet Protocol Suite is referred to [Ref13] for an introduction to IP.

### Router

A level three Internet Protocol packet switch. Formerly called a gateway in much of the IP literature.

### Autonomous System

A group of routers exchanging routing information via a common routing protocol. Abbreviated as AS.

### Interior Gateway Protocol

The routing protocol spoken by the routers belonging to an Autonomous system. Abbreviated as IGP. Each Autonomous System has a single IGP. Separate Autonomous Systems may be running different IGPs.

### Router ID

A 32-bit number assigned to each router running the OSPF protocol. This number uniquely identifies the router within an Autonomous System.

### Network

In this memo, an IP network/subnet/supernet. It is possible for one physical network to be assigned multiple IP network/subnet numbers. We consider these to be separate networks. Point-to-point physical networks are an exception - they are considered a single network no matter how many (if any at all) IP network/subnet numbers are assigned to them.

### Network mask

A 32-bit number indicating the range of IP addresses residing on a single IP network/subnet/supernet. This specification displays network masks as hexadecimal numbers.



For example, the network mask for a class C IP network is displayed as 0xffffffff00. Such a mask is often displayed elsewhere in the literature as 255.255.255.0.

#### Point-to-point networks

A network that joins a single pair of routers. A 56Kb serial line is an example of a point-to-point network.

#### Broadcast networks

Networks supporting many (more than two) attached routers, together with the capability to address a single physical message to all of the attached routers (broadcast). Neighboring routers are discovered dynamically on these nets using OSPF's Hello Protocol. The Hello Protocol itself takes advantage of the broadcast capability. The OSPF protocol makes further use of multicast capabilities, if they exist. Each pair of routers on a broadcast network is assumed to be able to communicate directly. An ethernet is an example of a broadcast network.

#### Non-broadcast networks

Networks supporting many (more than two) routers, but having no broadcast capability. Neighboring routers are maintained on these nets using OSPF's Hello Protocol. However, due to the lack of broadcast capability, some configuration information may be necessary to aid in the discovery of neighbors. On non-broadcast networks, OSPF protocol packets that are normally multicast need to be sent to each neighboring router, in turn. An X.25 Public Data Network (PDN) is an example of a non-broadcast network.

OSPF runs in one of two modes over non-broadcast networks. The first mode, called non-broadcast multi-access or NBMA, simulates the operation of OSPF on a broadcast network. The second mode, called Point-to-MultiPoint, treats the non-broadcast network as a collection of point-to-point links. Non-broadcast networks are referred to as NBMA networks or Point-to-MultiPoint networks, depending on OSPF's mode of operation over the network.

#### Interface

The connection between a router and one of its attached networks. An interface has state information associated with it, which is obtained from the underlying lower level protocols and the routing protocol itself. An interface to a network has associated with it a single IP address and mask (unless the network is an unnumbered point-to-point network). An interface is sometimes also referred to as a link.

#### Neighboring routers

Two routers that have interfaces to a common network. Neighbor relationships are maintained by, and usually dynamically discovered by, OSPF's Hello Protocol.

#### Adjacency

A relationship formed between selected neighboring routers for the purpose of exchanging routing information. Not every pair of neighboring routers become adjacent.

#### Link state advertisement

Unit of data describing the local state of a router or network. For a router, this includes the state of the router's interfaces and adjacencies. Each link state advertisement is flooded throughout the routing domain. The collected link state advertisements of all routers and networks forms the protocol's link state database. Throughout this memo, link state advertisement is abbreviated as LSA.

#### Hello Protocol

The part of the OSPF protocol used to establish and maintain neighbor relationships. On broadcast networks the Hello Protocol can also dynamically discover neighboring routers.

#### Flooding

The part of the OSPF protocol that distributes and synchronizes the link-state database between OSPF routers.

#### Designated Router

Each broadcast and NBMA network that has at least two attached routers has a Designated Router. The Designated

Router generates an LSA for the network and has other special responsibilities in the running of the protocol. The Designated Router is elected by the Hello Protocol.

The Designated Router concept enables a reduction in the number of adjacencies required on a broadcast or NBMA network. This in turn reduces the amount of routing protocol traffic and the size of the link-state database.

#### Lower-level protocols

The underlying network access protocols that provide services to the Internet Protocol and in turn the OSPF protocol. Examples of these are the X.25 packet and frame levels for X.25 PDNs, and the ethernet data link layer for ethernets.

### 1.3. Brief history of link-state routing technology

OSPF is a link state routing protocol. Such protocols are also referred to in the literature as SPF-based or distributed-database protocols. This section gives a brief description of the developments in link-state technology that have influenced the OSPF protocol.

The first link-state routing protocol was developed for use in the ARPANET packet switching network. This protocol is described in [Ref3]. It has formed the starting point for all other link-state protocols. The homogeneous ARPANET environment, i.e., single-vendor packet switches connected by synchronous serial lines, simplified the design and implementation of the original protocol.

Modifications to this protocol were proposed in [Ref4]. These modifications dealt with increasing the fault tolerance of the routing protocol through, among other things, adding a checksum to the LSAs (thereby detecting database corruption). The paper also included means for reducing the routing traffic overhead in a link-state protocol. This was accomplished by introducing mechanisms which enabled the interval between LSA originations to be increased by an order of magnitude.

A link-state algorithm has also been proposed for use as an ISO IS-IS routing protocol. This protocol is described in [Ref2]. The protocol includes methods for data and routing traffic reduction when operating over broadcast networks. This is accomplished by election of a Designated Router for each broadcast network, which then originates an LSA for the network.

The OSPF Working Group of the IETF has extended this work in developing the OSPF protocol. The Designated Router concept has been greatly enhanced to further reduce the amount of routing traffic required. Multicast capabilities are utilized for additional routing bandwidth reduction. An area routing scheme has been developed enabling information hiding/protection/reduction. Finally, the algorithms have been tailored for efficient operation in TCP/IP internets.

#### 1.4. Organization of this document

The first three sections of this specification give a general overview of the protocol's capabilities and functions. Sections 4-16 explain the protocol's mechanisms in detail. Packet formats, protocol constants and configuration items are specified in the appendices.

Labels such as HelloInterval encountered in the text refer to protocol constants. They may or may not be configurable. Architectural constants are summarized in Appendix B. Configurable constants are summarized in Appendix C.

The detailed specification of the protocol is presented in terms of data structures. This is done in order to make the explanation more precise. Implementations of the protocol are required to support the functionality described, but need not use the precise data structures that appear in this memo.

#### 1.5. Acknowledgments

The author would like to thank Ran Atkinson, Fred Baker, Jeffrey Burgan, Rob Coltun, Dino Farinacci, Vince Fuller, Phanindra Jujjavarapu, Milo Medin, Tom Pusateri, Kannan Varadhan, Zhaohui

Zhang and the rest of the OSPF Working Group for the ideas and support they have given to this project.

The OSPF Point-to-MultiPoint interface is based on work done by Fred Baker.

The OSPF Cryptographic Authentication option was developed by Fred Baker and Ran Atkinson.

## 2. The Link-state Database: organization and calculations

The following subsections describe the organization of OSPF's link-state database, and the routing calculations that are performed on the database in order to produce a router's routing table.

### 2.1. Representation of routers and networks

The Autonomous System's link-state database describes a directed graph. The vertices of the graph consist of routers and networks. A graph edge connects two routers when they are attached via a physical point-to-point network. An edge connecting a router to a network indicates that the router has an interface on the network. Networks can be either transit or stub networks. Transit networks are those capable of carrying data traffic that is neither locally originated nor locally destined. A transit network is represented by a graph vertex having both incoming and outgoing edges. A stub network's vertex has only incoming edges.

The neighborhood of each network node in the graph depends on the network's type (point-to-point, broadcast, NBMA or Point-to-MultiPoint) and the number of routers having an interface to the network. Three cases are depicted in Figure 1a. Rectangles indicate routers. Circles and oblongs indicate networks. Router names are prefixed with the letters RT and network names with the letter N. Router interface names are prefixed by the letter I. Lines between routers indicate point-to-point networks. The left side of the figure shows networks with their connected routers, with the resulting graphs shown on the right.

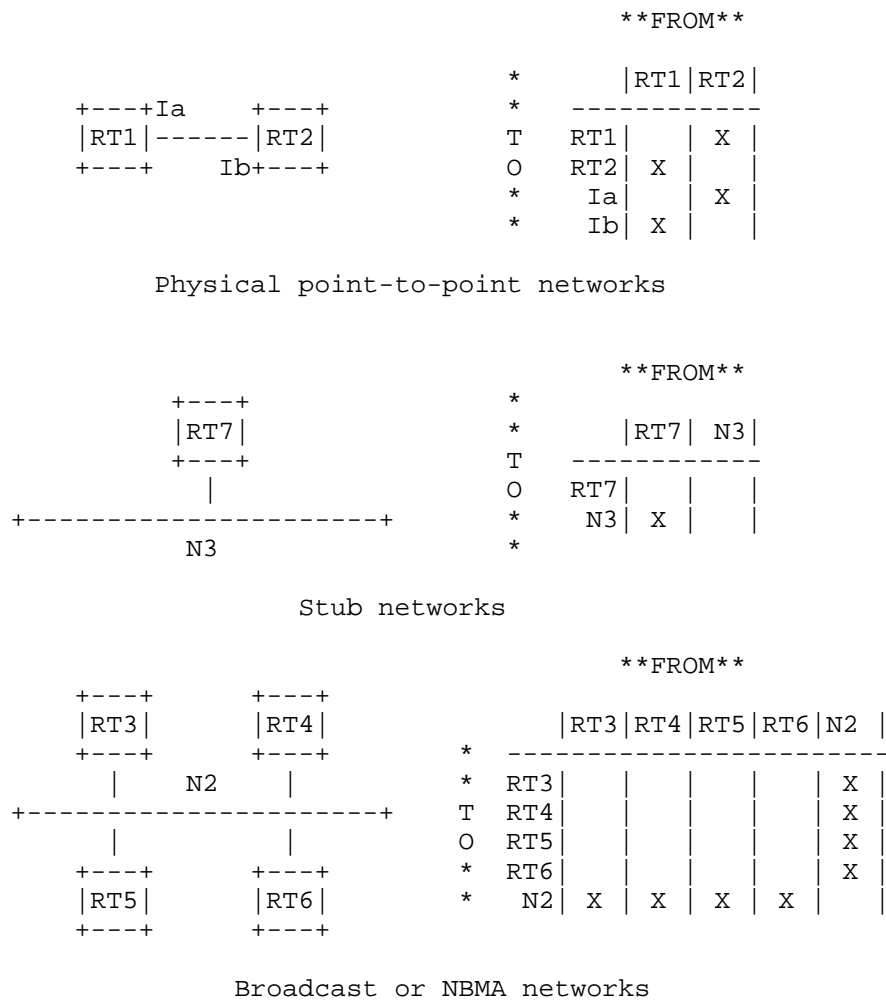

Figure 1a: Network map components

Networks and routers are represented by vertices. An edge connects Vertex A to Vertex B iff the intersection of Column A and Row B is marked with an X.

The top of Figure 1a shows two routers connected by a point-to-point link. In the resulting link-state database graph, the two router vertices are directly connected by a pair of edges, one in each direction. Interfaces to point-to-point networks need not be assigned IP addresses. When interface addresses are assigned, they are modelled as stub links, with each router advertising a stub connection to the other router's interface address. Optionally, an IP subnet can be assigned to the point-to-point network. In this case, both routers advertise a stub link to the IP subnet, instead of advertising each others' IP interface addresses.

The middle of Figure 1a shows a network with only one attached router (i.e., a stub network). In this case, the network appears on the end of a stub connection in the link-state database's graph.

When multiple routers are attached to a broadcast network, the link-state database graph shows all routers bidirectionally connected to the network vertex. This is pictured at the bottom of Figure 1a.

Each network (stub or transit) in the graph has an IP address and associated network mask. The mask indicates the number of nodes on the network. Hosts attached directly to routers (referred to as host routes) appear on the graph as stub networks. The network mask for a host route is always 0xffffffff, which indicates the presence of a single node.

#### 2.1.1. Representation of non-broadcast networks

As mentioned previously, OSPF can run over non-broadcast networks in one of two modes: NBMA or Point-to-MultiPoint. The choice of mode determines the way that the Hello

protocol and flooding work over the non-broadcast network, and the way that the network is represented in the link-state database.

In NBMA mode, OSPF emulates operation over a broadcast network: a Designated Router is elected for the NBMA network, and the Designated Router originates an LSA for the network. The graph representation for broadcast networks and NBMA networks is identical. This representation is pictured in the middle of Figure 1a.

NBMA mode is the most efficient way to run OSPF over non-broadcast networks, both in terms of link-state database size and in terms of the amount of routing protocol traffic. However, it has one significant restriction: it requires all routers attached to the NBMA network to be able to communicate directly. This restriction may be met on some non-broadcast networks, such as an ATM subnet utilizing SVCs. But it is often not met on other non-broadcast networks, such as PVC-only Frame Relay networks. On non-broadcast networks where not all routers can communicate directly you can break the non-broadcast network into logical subnets, with the routers on each subnet being able to communicate directly, and then run each separate subnet as an NBMA network (see [Ref15]). This however requires quite a bit of administrative overhead, and is prone to misconfiguration. It is probably better to run such a non-broadcast network in Point-to-Multipoint mode.

In Point-to-MultiPoint mode, OSPF treats all router-to-router connections over the non-broadcast network as if they were point-to-point links. No Designated Router is elected for the network, nor is there an LSA generated for the network. In fact, a vertex for the Point-to-MultiPoint network does not appear in the graph of the link-state database.

Figure 1b illustrates the link-state database representation of a Point-to-MultiPoint network. On the left side of the figure, a Point-to-MultiPoint network is pictured. It is assumed that all routers can communicate directly, except for routers RT4 and RT5. I3 though I6 indicate the routers'



IP interface addresses on the Point-to-MultiPoint network. In the graphical representation of the link-state database, routers that can communicate directly over the Point-to-MultiPoint network are joined by bidirectional edges, and each router also has a stub connection to its own IP interface address (which is in contrast to the representation of real point-to-point links; see Figure 1a).

On some non-broadcast networks, use of Point-to-MultiPoint mode and data-link protocols such as Inverse ARP (see [Ref14]) will allow autodiscovery of OSPF neighbors even though broadcast support is not available.

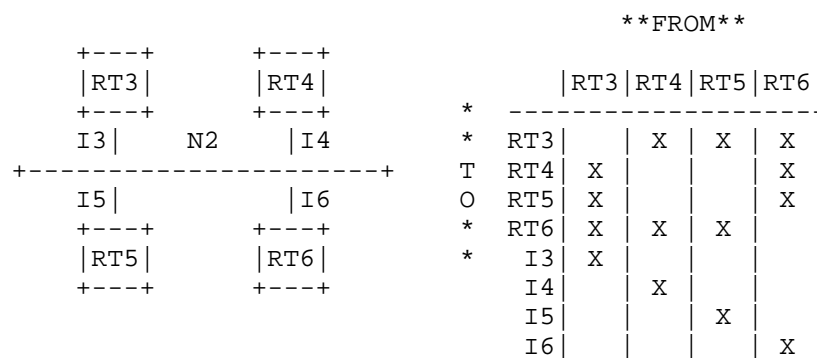

Figure 1b: Network map components  
Point-to-MultiPoint networks

All routers can communicate directly over N2, except routers RT4 and RT5. I3 through I6 indicate IP interface addresses

### 2.1.2. An example link-state database

Figure 2 shows a sample map of an Autonomous System. The rectangle labelled H1 indicates a host, which has a SLIP connection to Router RT12. Router RT12 is therefore advertising a host route. Lines between routers indicate physical point-to-point networks. The only point-to-point network that has been assigned interface addresses is the one joining Routers RT6 and RT10. Routers RT5 and RT7 have BGP connections to other Autonomous Systems. A set of BGP-learned routes have been displayed for both of these routers.

A cost is associated with the output side of each router interface. This cost is configurable by the system administrator. The lower the cost, the more likely the interface is to be used to forward data traffic. Costs are also associated with the externally derived routing data (e.g., the BGP-learned routes).

The directed graph resulting from the map in Figure 2 is depicted in Figure 3. Arcs are labelled with the cost of the corresponding router output interface. Arcs having no labelled cost have a cost of 0. Note that arcs leading from networks to routers always have cost 0; they are significant nonetheless. Note also that the externally derived routing data appears on the graph as stubs.

The link-state database is pieced together from LSAs generated by the routers. In the associated graphical representation, the neighborhood of each router or transit network is represented in a single, separate LSA. Figure 4 shows these LSAs graphically. Router RT12 has an interface to two broadcast networks and a SLIP line to a host. Network N6 is a broadcast network with three attached routers. The cost of all links from Network N6 to its attached routers is 0. Note that the LSA for Network N6 is actually generated by one of the network's attached routers: the router that has been elected Designated Router for the network.



Figure 2: A sample Autonomous System

\*\*FROM\*\*

	RT 1	RT 2	RT 3	RT 4	RT 5	RT 6	RT 7	RT 8	RT 9	RT 10	RT 11	RT 12	N3	N6	N8	N9
RT1													0			
RT2													0			
RT3						6							0			
RT4					8								0			
RT5				8		6	6									
RT6			8		7					5						
RT7					6									0		
* RT8														0		
* RT9																0
T RT10						7								0	0	
O RT11															0	0
* RT12																0
* N1	3															
N2		3														
N3	1	1	1	1												
N4			2													
N6							1	1		1						
N7								4								
N8										3	2					
N9									1		1	1				
N10												2				
N11									3							
N12					8		2									
N13					8											
N14					8											
N15							9									
H1												10				

Figure 3: The resulting directed graph

Networks and routers are represented by vertices. An edge of cost X connects Vertex A to Vertex B iff the intersection of Column A and Row B is marked with an X.

**FROM**					**FROM**					
RT12 N9 N10 H1					RT9 RT11 RT12 N9					
-----					-----					
*	RT12				*	RT9				
T	N9	1			T	RT11				0
O	N10	2			O	RT12				0
*	H1	10			*	N9				
*					*					
	RT12's router-LSA					N9's network-LSA				

Figure 4: Individual link state components

Networks and routers are represented by vertices. An edge of cost X connects Vertex A to Vertex B iff the intersection of Column A and Row B is marked with an X.

2.2. The shortest-path tree

When no OSPF areas are configured, each router in the Autonomous System has an identical link-state database, leading to an identical graphical representation. A router generates its routing table from this graph by calculating a tree of shortest paths with the router itself as root. Obviously, the shortest-path tree depends on the router doing the calculation. The shortest-path tree for Router RT6 in our example is depicted in Figure 5.

The tree gives the entire path to any destination network or host. However, only the next hop to the destination is used in the forwarding process. Note also that the best route to any router has also been calculated. For the processing of external data, we note the next hop and distance to any router advertising external routes. The resulting routing table for Router RT6 is pictured in Table 2. Note that there is a separate route for each end of a numbered point-to-point network (in this case, the serial line between Routers RT6 and RT10).

Routes to networks belonging to other AS'es (such as N12) appear as dashed lines on the shortest path tree in Figure 5. Use of

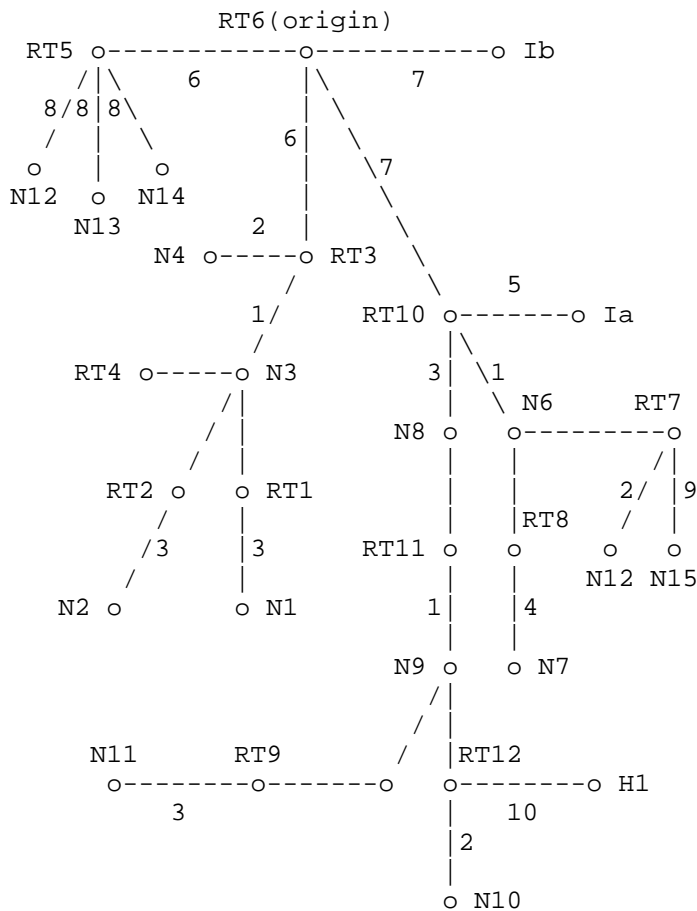

Figure 5: The SPF tree for Router RT6

Edges that are not marked with a cost have a cost of zero (these are network-to-router links). Routes to networks N12-N15 are external information that is considered in Section 2.3

Destination	Next Hop	Distance
N1	RT3	10
N2	RT3	10
N3	RT3	7
N4	RT3	8
Ib	*	7
Ia	RT10	12
N6	RT10	8
N7	RT10	12
N8	RT10	10
N9	RT10	11
N10	RT10	13
N11	RT10	14
H1	RT10	21
RT5	RT5	6
RT7	RT10	8

Table 2: The portion of Router RT6's routing table listing local destinations.

this externally derived routing information is considered in the next section.

### 2.3. Use of external routing information

After the tree is created the external routing information is examined. This external routing information may originate from another routing protocol such as BGP, or be statically configured (static routes). Default routes can also be included as part of the Autonomous System's external routing information.

External routing information is flooded unaltered throughout the AS. In our example, all the routers in the Autonomous System know that Router RT7 has two external routes, with metrics 2 and 9.

OSPF supports two types of external metrics. Type 1 external metrics are expressed in the same units as OSPF interface cost

(i.e., in terms of the link state metric). Type 2 external metrics are an order of magnitude larger; any Type 2 metric is considered greater than the cost of any path internal to the AS. Use of Type 2 external metrics assumes that routing between AS'es is the major cost of routing a packet, and eliminates the need for conversion of external costs to internal link state metrics.

As an example of Type 1 external metric processing, suppose that the Routers RT7 and RT5 in Figure 2 are advertising Type 1 external metrics. For each advertised external route, the total cost from Router RT6 is calculated as the sum of the external route's advertised cost and the distance from Router RT6 to the advertising router. When two routers are advertising the same external destination, RT6 picks the advertising router providing the minimum total cost. RT6 then sets the next hop to the external destination equal to the next hop that would be used when routing packets to the chosen advertising router.

In Figure 2, both Router RT5 and RT7 are advertising an external route to destination Network N12. Router RT7 is preferred since it is advertising N12 at a distance of 10 (8+2) to Router RT6, which is better than Router RT5's 14 (6+8). Table 3 shows the entries that are added to the routing table when external routes are examined:

Destination	Next Hop	Distance
N12	RT10	10
N13	RT5	14
N14	RT5	14
N15	RT10	17

Table 3: The portion of Router RT6's routing table listing external destinations.

Processing of Type 2 external metrics is simpler. The AS boundary router advertising the smallest external metric is



chosen, regardless of the internal distance to the AS boundary router. Suppose in our example both Router RT5 and Router RT7 were advertising Type 2 external routes. Then all traffic destined for Network N12 would be forwarded to Router RT7, since  $2 < 8$ . When several equal-cost Type 2 routes exist, the internal distance to the advertising routers is used to break the tie.

Both Type 1 and Type 2 external metrics can be present in the AS at the same time. In that event, Type 1 external metrics always take precedence.

This section has assumed that packets destined for external destinations are always routed through the advertising AS boundary router. This is not always desirable. For example, suppose in Figure 2 there is an additional router attached to Network N6, called Router RTX. Suppose further that RTX does not participate in OSPF routing, but does exchange BGP information with the AS boundary router RT7. Then, Router RT7 would end up advertising OSPF external routes for all destinations that should be routed to RTX. An extra hop will sometimes be introduced if packets for these destinations need always be routed first to Router RT7 (the advertising router).

To deal with this situation, the OSPF protocol allows an AS boundary router to specify a "forwarding address" in its AS-external-LSAs. In the above example, Router RT7 would specify RTX's IP address as the "forwarding address" for all those destinations whose packets should be routed directly to RTX.

The "forwarding address" has one other application. It enables routers in the Autonomous System's interior to function as "route servers". For example, in Figure 2 the router RT6 could become a route server, gaining external routing information through a combination of static configuration and external routing protocols. RT6 would then start advertising itself as an AS boundary router, and would originate a collection of OSPF AS-external-LSAs. In each AS-external-LSA, Router RT6 would specify the correct Autonomous System exit point to use for the destination through appropriate setting of the LSA's "forwarding address" field.

#### 2.4. Equal-cost multipath

The above discussion has been simplified by considering only a single route to any destination. In reality, if multiple equal-cost routes to a destination exist, they are all discovered and used. This requires no conceptual changes to the algorithm, and its discussion is postponed until we consider the tree-building process in more detail.

With equal cost multipath, a router potentially has several available next hops towards any given destination.

### 3. Splitting the AS into Areas

OSPF allows collections of contiguous networks and hosts to be grouped together. Such a group, together with the routers having interfaces to any one of the included networks, is called an area. Each area runs a separate copy of the basic link-state routing algorithm. This means that each area has its own link-state database and corresponding graph, as explained in the previous section.

The topology of an area is invisible from the outside of the area. Conversely, routers internal to a given area know nothing of the detailed topology external to the area. This isolation of knowledge enables the protocol to effect a marked reduction in routing traffic as compared to treating the entire Autonomous System as a single link-state domain.

With the introduction of areas, it is no longer true that all routers in the AS have an identical link-state database. A router actually has a separate link-state database for each area it is connected to. (Routers connected to multiple areas are called area border routers). Two routers belonging to the same area have, for that area, identical area link-state databases.

Routing in the Autonomous System takes place on two levels, depending on whether the source and destination of a packet reside in the same area (intra-area routing is used) or different areas (inter-area routing is used). In intra-area routing, the packet is routed solely on information obtained within the area; no routing

information obtained from outside the area can be used. This protects intra-area routing from the injection of bad routing information. We discuss inter-area routing in Section 3.2.

### 3.1. The backbone of the Autonomous System

The OSPF backbone is the special OSPF Area 0 (often written as Area 0.0.0.0, since OSPF Area ID's are typically formatted as IP addresses). The OSPF backbone always contains all area border routers. The backbone is responsible for distributing routing information between non-backbone areas. The backbone must be contiguous. However, it need not be physically contiguous; backbone connectivity can be established/maintained through the configuration of virtual links.

Virtual links can be configured between any two backbone routers that have an interface to a common non-backbone area. Virtual links belong to the backbone. The protocol treats two routers joined by a virtual link as if they were connected by an unnumbered point-to-point backbone network. On the graph of the backbone, two such routers are joined by arcs whose costs are the intra-area distances between the two routers. The routing protocol traffic that flows along the virtual link uses intra-area routing only.

### 3.2. Inter-area routing

When routing a packet between two non-backbone areas the backbone is used. The path that the packet will travel can be broken up into three contiguous pieces: an intra-area path from the source to an area border router, a backbone path between the source and destination areas, and then another intra-area path to the destination. The algorithm finds the set of such paths that have the smallest cost.

Looking at this another way, inter-area routing can be pictured as forcing a star configuration on the Autonomous System, with the backbone as hub and each of the non-backbone areas as spokes.

The topology of the backbone dictates the backbone paths used between areas. The topology of the backbone can be enhanced by adding virtual links. This gives the system administrator some control over the routes taken by inter-area traffic.

The correct area border router to use as the packet exits the source area is chosen in exactly the same way routers advertising external routes are chosen. Each area border router in an area summarizes for the area its cost to all networks external to the area. After the SPF tree is calculated for the area, routes to all inter-area destinations are calculated by examining the summaries of the area border routers.

### 3.3. Classification of routers

Before the introduction of areas, the only OSPF routers having a specialized function were those advertising external routing information, such as Router RT5 in Figure 2. When the AS is split into OSPF areas, the routers are further divided according to function into the following four overlapping categories:

#### Internal routers

A router with all directly connected networks belonging to the same area. These routers run a single copy of the basic routing algorithm.

#### Area border routers

A router that attaches to multiple areas. Area border routers run multiple copies of the basic algorithm, one copy for each attached area. Area border routers condense the topological information of their attached areas for distribution to the backbone. The backbone in turn distributes the information to the other areas.

#### Backbone routers

A router that has an interface to the backbone area. This includes all routers that interface to more than one area (i.e., area border routers). However, backbone routers do not have to be area border routers. Routers with all interfaces connecting to the backbone area are supported.

#### AS boundary routers

A router that exchanges routing information with routers belonging to other Autonomous Systems. Such a router advertises AS external routing information throughout the Autonomous System. The paths to each AS boundary router are known by every router in the AS. This classification is completely independent of the previous classifications: AS boundary routers may be internal or area border routers, and may or may not participate in the backbone.

### 3.4. A sample area configuration

Figure 6 shows a sample area configuration. The first area consists of networks N1-N4, along with their attached routers RT1-RT4. The second area consists of networks N6-N8, along with their attached routers RT7, RT8, RT10 and RT11. The third area consists of networks N9-N11 and Host H1, along with their attached routers RT9, RT11 and RT12. The third area has been configured so that networks N9-N11 and Host H1 will all be grouped into a single route, when advertised external to the area (see Section 3.5 for more details).

In Figure 6, Routers RT1, RT2, RT5, RT6, RT8, RT9 and RT12 are internal routers. Routers RT3, RT4, RT7, RT10 and RT11 are area border routers. Finally, as before, Routers RT5 and RT7 are AS boundary routers.

Figure 7 shows the resulting link-state database for the Area 1. The figure completely describes that area's intra-area routing. It also shows the complete view of the internet for the two internal routers RT1 and RT2. It is the job of the area border routers, RT3 and RT4, to advertise into Area 1 the distances to all destinations external to the area. These are indicated in Figure 7 by the dashed stub routes. Also, RT3 and RT4 must advertise into Area 1 the location of the AS boundary routers RT5 and RT7. Finally, AS-external-LSAs from RT5 and RT7 are flooded throughout the entire AS, and in particular throughout Area 1. These LSAs are included in Area 1's database, and yield routes to Networks N12-N15.

Routers RT3 and RT4 must also summarize Area 1's topology for



```

.           N10           .   .           N7           .
.                               .   .Area 2           .
.Area 3           .   .....
.....

```

Figure 6: A sample OSPF area configuration

distribution to the backbone. Their backbone LSAs are shown in Table 4. These summaries show which networks are contained in Area 1 (i.e., Networks N1-N4), and the distance to these networks from the routers RT3 and RT4 respectively.

The link-state database for the backbone is shown in Figure 8. The set of routers pictured are the backbone routers. Router RT11 is a backbone router because it belongs to two areas. In order to make the backbone connected, a virtual link has been configured between Routers R10 and R11.

The area border routers RT3, RT4, RT7, RT10 and RT11 condense the routing information of their attached non-backbone areas for distribution via the backbone; these are the dashed stubs that appear in Figure 8. Remember that the third area has been configured to condense Networks N9-N11 and Host H1 into a single route. This yields a single dashed line for networks N9-N11 and Host H1 in Figure 8. Routers RT5 and RT7 are AS boundary routers; their externally derived information also appears on the graph in Figure 8 as stubs.

Network	RT3 adv.	RT4 adv.
N1	4	4
N2	4	4
N3	1	1
N4	2	3

Table 4: Networks advertised to the backbone by Routers RT3 and RT4.

\*\*FROM\*\*

	RT 1	RT 2	RT 3	RT 4	RT 5	RT 7	N3
RT1							0
RT2							0
RT3							0
* RT4							0
* RT5			14	8			
T RT7			20	14			
O N1	3						
* N2		3					
* N3	1	1	1	1			
N4			2				
Ia, Ib			20	27			
N6			16	15			
N7			20	19			
N8			18	18			
N9-N11, H1			29	36			
N12					8	2	
N13					8		
N14					8		
N15						9	

Figure 7: Area 1's Database.

Networks and routers are represented by vertices.  
 An edge of cost X connects Vertex A to Vertex B iff  
 the intersection of Column A and Row B is marked  
 with an X.



\*\*FROM\*\*

	RT 3	RT 4	RT 5	RT 6	RT 7	RT 10	RT 11
RT3				6			
RT4			8				
RT5		8		6	6		
RT6	8		7			5	
RT7			6				
* RT10				7			2
* RT11						3	
T N1	4	4					
O N2	4	4					
* N3	1	1					
* N4	2	3					
Ia						5	
Ib				7			
N6					1	1	3
N7					5	5	7
N8					4	3	2
N9-N11,H1							11
N12			8		2		
N13			8				
N14			8				
N15					9		

Figure 8: The backbone's database.

Networks and routers are represented by vertices. An edge of cost X connects Vertex A to Vertex B iff the intersection of Column A and Row B is marked with an X.

The backbone enables the exchange of summary information between area border routers. Every area border router hears the area summaries from all other area border routers. It then forms a picture of the distance to all networks outside of its area by examining the collected LSAs, and adding in the backbone distance to each advertising router.

Again using Routers RT3 and RT4 as an example, the procedure goes as follows: They first calculate the SPF tree for the backbone. This gives the distances to all other area border routers. Also noted are the distances to networks (Ia and Ib) and AS boundary routers (RT5 and RT7) that belong to the backbone. This calculation is shown in Table 5.

Next, by looking at the area summaries from these area border routers, RT3 and RT4 can determine the distance to all networks outside their area. These distances are then advertised internally to the area by RT3 and RT4. The advertisements that Router RT3 and RT4 will make into Area 1 are shown in Table 6. Note that Table 6 assumes that an area range has been configured for the backbone which groups Ia and Ib into a single LSA.

The information imported into Area 1 by Routers RT3 and RT4 enables an internal router, such as RT1, to choose an area border router intelligently. Router RT1 would use RT4 for traffic to Network N6, RT3 for traffic to Network N10, and would

		dist	from	dist	from
		RT3		RT4	
to	RT3	*		21	
to	RT4	22		*	
to	RT7	20		14	
to	RT10	15		22	
to	RT11	18		25	
<hr/>					
to	Ia	20		27	
to	Ib	15		22	
<hr/>					
to	RT5	14		8	
to	RT7	20		14	

Table 5: Backbone distances calculated by Routers RT3 and RT4.

Destination	RT3 adv.	RT4 adv.
Ia, Ib	20	27
N6	16	15
N7	20	19
N8	18	18
N9-N11, H1	29	36
RT5	14	8
RT7	20	14

Table 6: Destinations advertised into Area 1  
by Routers RT3 and RT4.

load share between the two for traffic to Network N8.

Router RT1 can also determine in this manner the shortest path to the AS boundary routers RT5 and RT7. Then, by looking at RT5 and RT7's AS-external-LSAs, Router RT1 can decide between RT5 or RT7 when sending to a destination in another Autonomous System (one of the networks N12-N15).

Note that a failure of the line between Routers RT6 and RT10 will cause the backbone to become disconnected. Configuring a virtual link between Routers RT7 and RT10 will give the backbone more connectivity and more resistance to such failures.

### 3.5. IP subnetting support

OSPF attaches an IP address mask to each advertised route. The mask indicates the range of addresses being described by the particular route. For example, a summary-LSA for the destination 128.185.0.0 with a mask of 0xffff0000 actually is describing a single route to the collection of destinations 128.185.0.0 - 128.185.255.255. Similarly, host routes are always advertised with a mask of 0xffffffff, indicating the presence of only a single destination.

Including the mask with each advertised destination enables the implementation of what is commonly referred to as variable-length subnetting. This means that a single IP class A, B, or C network number can be broken up into many subnets of various sizes. For example, the network 128.185.0.0 could be broken up into 62 variable-sized subnets: 15 subnets of size 4K, 15 subnets of size 256, and 32 subnets of size 8. Table 7 shows some of the resulting network addresses together with their masks.

Network address	IP address mask	Subnet size
128.185.16.0	0xfffff000	4K
128.185.1.0	0xfffff00	256
128.185.0.8	0xfffffff8	8

Table 7: Some sample subnet sizes.

There are many possible ways of dividing up a class A, B, and C network into variable sized subnets. The precise procedure for doing so is beyond the scope of this specification. This specification however establishes the following guideline: When an IP packet is forwarded, it is always forwarded to the network that is the best match for the packet's destination. Here best match is synonymous with the longest or most specific match. For example, the default route with destination of 0.0.0.0 and mask 0x00000000 is always a match for every IP destination. Yet it is always less specific than any other match. Subnet masks must be assigned so that the best match for any IP destination is unambiguous.

Attaching an address mask to each route also enables the support of IP supernetting. For example, a single physical network segment could be assigned the [address,mask] pair [192.9.4.0,0xfffffc00]. The segment would then be single IP network, containing addresses from the four consecutive class C network numbers 192.9.4.0 through 192.9.7.0. Such addressing is now becoming commonplace with the advent of CIDR (see [Ref10]).

In order to get better aggregation at area boundaries, area address ranges can be employed (see Section C.2 for more details). Each address range is defined as an [address,mask] pair. Many separate networks may then be contained in a single address range, just as a subnetted network is composed of many separate subnets. Area border routers then summarize the area contents (for distribution to the backbone) by advertising a single route for each address range. The cost of the route is the maximum cost to any of the networks falling in the specified range.

For example, an IP subnetted network might be configured as a single OSPF area. In that case, a single address range could be configured: a class A, B, or C network number along with its natural IP mask. Inside the area, any number of variable sized subnets could be defined. However, external to the area a single route for the entire subnetted network would be distributed, hiding even the fact that the network is subnetted at all. The cost of this route is the maximum of the set of costs to the component subnets.

### 3.6. Supporting stub areas

In some Autonomous Systems, the majority of the link-state database may consist of AS-external-LSAs. An OSPF AS-external-LSA is usually flooded throughout the entire AS. However, OSPF allows certain areas to be configured as "stub areas". AS-external-LSAs are not flooded into/throughout stub areas; routing to AS external destinations in these areas is based on a (per-area) default only. This reduces the link-state database size, and therefore the memory requirements, for a stub area's internal routers.

In order to take advantage of the OSPF stub area support, default routing must be used in the stub area. This is accomplished as follows. One or more of the stub area's area border routers must advertise a default route into the stub area via summary-LSAs. These summary defaults are flooded throughout the stub area, but no further. (For this reason these defaults pertain only to the particular stub area). These summary default routes will be used for any destination that is not

explicitly reachable by an intra-area or inter-area path (i.e., AS external destinations).

An area can be configured as a stub when there is a single exit point from the area, or when the choice of exit point need not be made on a per-external-destination basis. For example, Area 3 in Figure 6 could be configured as a stub area, because all external traffic must travel through its single area border router RT11. If Area 3 were configured as a stub, Router RT11 would advertise a default route for distribution inside Area 3 (in a summary-LSA), instead of flooding the AS-external-LSAs for Networks N12-N15 into/throughout the area.

The OSPF protocol ensures that all routers belonging to an area agree on whether the area has been configured as a stub. This guarantees that no confusion will arise in the flooding of AS-external-LSAs.

There are a couple of restrictions on the use of stub areas. Virtual links cannot be configured through stub areas. In addition, AS boundary routers cannot be placed internal to stub areas.

### 3.7. Partitions of areas

OSPF does not actively attempt to repair area partitions. When an area becomes partitioned, each component simply becomes a separate area. The backbone then performs routing between the new areas. Some destinations reachable via intra-area routing before the partition will now require inter-area routing.

However, in order to maintain full routing after the partition, an address range must not be split across multiple components of the area partition. Also, the backbone itself must not partition. If it does, parts of the Autonomous System will become unreachable. Backbone partitions can be repaired by configuring virtual links (see Section 15).

Another way to think about area partitions is to look at the Autonomous System graph that was introduced in Section 2. Area IDs can be viewed as colors for the graph's edges.[1] Each edge

of the graph connects to a network, or is itself a point-to-point network. In either case, the edge is colored with the network's Area ID.

A group of edges, all having the same color, and interconnected by vertices, represents an area. If the topology of the Autonomous System is intact, the graph will have several regions of color, each color being a distinct Area ID.

When the AS topology changes, one of the areas may become partitioned. The graph of the AS will then have multiple regions of the same color (Area ID). The routing in the Autonomous System will continue to function as long as these regions of same color are connected by the single backbone region.

#### 4. Functional Summary

A separate copy of OSPF's basic routing algorithm runs in each area. Routers having interfaces to multiple areas run multiple copies of the algorithm. A brief summary of the routing algorithm follows.

When a router starts, it first initializes the routing protocol data structures. The router then waits for indications from the lower-level protocols that its interfaces are functional.

A router then uses the OSPF's Hello Protocol to acquire neighbors. The router sends Hello packets to its neighbors, and in turn receives their Hello packets. On broadcast and point-to-point networks, the router dynamically detects its neighboring routers by sending its Hello packets to the multicast address AllSPFRouters. On non-broadcast networks, some configuration information may be necessary in order to discover neighbors. On broadcast and NBMA networks the Hello Protocol also elects a Designated router for the network.

The router will attempt to form adjacencies with some of its newly acquired neighbors. Link-state databases are synchronized between pairs of adjacent routers. On broadcast and NBMA networks, the Designated Router determines which routers should become adjacent.

Adjacencies control the distribution of routing information. Routing updates are sent and received only on adjacencies.

A router periodically advertises its state, which is also called link state. Link state is also advertised when a router's state changes. A router's adjacencies are reflected in the contents of its LSAs. This relationship between adjacencies and link state allows the protocol to detect dead routers in a timely fashion.

LSAs are flooded throughout the area. The flooding algorithm is reliable, ensuring that all routers in an area have exactly the same link-state database. This database consists of the collection of LSAs originated by each router belonging to the area. From this database each router calculates a shortest-path tree, with itself as root. This shortest-path tree in turn yields a routing table for the protocol.



#### 4.1. Inter-area routing

The previous section described the operation of the protocol within a single area. For intra-area routing, no other routing information is pertinent. In order to be able to route to destinations outside of the area, the area border routers inject additional routing information into the area. This additional information is a distillation of the rest of the Autonomous System's topology.

This distillation is accomplished as follows: Each area border router is by definition connected to the backbone. Each area border router summarizes the topology of its attached non-backbone areas for transmission on the backbone, and hence to all other area border routers. An area border router then has complete topological information concerning the backbone, and the area summaries from each of the other area border routers. From this information, the router calculates paths to all inter-area destinations. The router then advertises these paths into its attached areas. This enables the area's internal routers to pick the best exit router when forwarding traffic inter-area destinations.

#### 4.2. AS external routes

Routers that have information regarding other Autonomous Systems can flood this information throughout the AS. This external routing information is distributed verbatim to every participating router. There is one exception: external routing information is not flooded into "stub" areas (see Section 3.6).

To utilize external routing information, the path to all routers advertising external information must be known throughout the AS (excepting the stub areas). For that reason, the locations of these AS boundary routers are summarized by the (non-stub) area border routers.

### 4.3. Routing protocol packets

The OSPF protocol runs directly over IP, using IP protocol 89. OSPF does not provide any explicit fragmentation/reassembly support. When fragmentation is necessary, IP fragmentation/reassembly is used. OSPF protocol packets have been designed so that large protocol packets can generally be split into several smaller protocol packets. This practice is recommended; IP fragmentation should be avoided whenever possible.

Routing protocol packets should always be sent with the IP TOS field set to 0. If at all possible, routing protocol packets should be given preference over regular IP data traffic, both when being sent and received. As an aid to accomplishing this, OSPF protocol packets should have their IP precedence field set to the value Internetwork Control (see [Ref5]).

All OSPF protocol packets share a common protocol header that is described in Appendix A. The OSPF packet types are listed below in Table 8. Their formats are also described in Appendix A.

Type	Packet name	Protocol function
1	Hello	Discover/maintain neighbors
2	Database Description	Summarize database contents
3	Link State Request	Database download
4	Link State Update	Database update
5	Link State Ack	Flooding acknowledgment

Table 8: OSPF packet types.

OSPF's Hello protocol uses Hello packets to discover and maintain neighbor relationships. The Database Description and Link State Request packets are used in the forming of adjacencies. OSPF's reliable update mechanism is implemented by the Link State Update and Link State Acknowledgment packets.

Each Link State Update packet carries a set of new link state advertisements (LSAs) one hop further away from their point of origination. A single Link State Update packet may contain the LSAs of several routers. Each LSA is tagged with the ID of the originating router and a checksum of its link state contents. Each LSA also has a type field; the different types of OSPF LSAs are listed below in Table 9.

OSPF routing packets (with the exception of Hellos) are sent only over adjacencies. This means that all OSPF protocol packets travel a single IP hop, except those that are sent over virtual adjacencies. The IP source address of an OSPF protocol packet is one end of a router adjacency, and the IP destination address is either the other end of the adjacency or an IP multicast address.

#### 4.4. Basic implementation requirements

An implementation of OSPF requires the following pieces of system support:

##### Timers

Two different kind of timers are required. The first kind, called "single shot timers", fire once and cause a protocol event to be processed. The second kind, called "interval timers", fire at continuous intervals. These are used for the sending of packets at regular intervals. A good example of this is the regular broadcast of Hello packets. The granularity of both kinds of timers is one second.

Interval timers should be implemented to avoid drift. In some router implementations, packet processing can affect timer execution. When multiple routers are attached to a single network, all doing broadcasts, this can lead to the synchronization of routing packets (which should be avoided). If timers cannot be implemented to avoid drift, small random amounts should be added to/subtracted from the interval timer at each firing.

LS type	LSA name	LSA description
1	Router-LSAs	Originated by all routers. This LSA describes the collected states of the router's interfaces to an area. Flooded throughout a single area only.
2	Network-LSAs	Originated for broadcast and NBMA networks by the Designated Router. This LSA contains the list of routers connected to the network. Flooded throughout a single area only.
3,4	Summary-LSAs	Originated by area border routers, and flooded throughout the LSA's associated area. Each summary-LSA describes a route to a destination outside the area, yet still inside the AS (i.e., an inter-area route). Type 3 summary-LSAs describe routes to networks. Type 4 summary-LSAs describe routes to AS boundary routers.
5	AS-external-LSAs	Originated by AS boundary routers, and flooded throughout the AS. Each AS-external-LSA describes a route to a destination in another Autonomous System. Default routes for the AS can also be described by AS-external-LSAs.

Table 9: OSPF link state advertisements (LSAs).

**IP multicast**

Certain OSPF packets take the form of IP multicast datagrams. Support for receiving and sending IP multicast datagrams, along with the appropriate lower-level protocol support, is required. The IP multicast datagrams used by OSPF never travel more than one hop. For this reason, the ability to forward IP multicast datagrams is not required. For information on IP multicast, see [Ref7].

**Variable-length subnet support**

The router's IP protocol support must include the ability to divide a single IP class A, B, or C network number into many subnets of various sizes. This is commonly called variable-length subnetting; see Section 3.5 for details.

**IP supernetting support**

The router's IP protocol support must include the ability to aggregate contiguous collections of IP class A, B, and C networks into larger quantities called supernets. Supernetting has been proposed as one way to improve the scaling of IP routing in the worldwide Internet. For more information on IP supernetting, see [Ref10].

**Lower-level protocol support**

The lower level protocols referred to here are the network access protocols, such as the Ethernet data link layer. Indications must be passed from these protocols to OSPF as the network interface goes up and down. For example, on an ethernet it would be valuable to know when the ethernet transceiver cable becomes unplugged.

**Non-broadcast lower-level protocol support**

On non-broadcast networks, the OSPF Hello Protocol can be aided by providing an indication when an attempt is made to send a packet to a dead or non-existent router. For example, on an X.25 PDN a dead neighboring router may be

indicated by the reception of a X.25 clear with an appropriate cause and diagnostic, and this information would be passed to OSPF.

#### List manipulation primitives

Much of the OSPF functionality is described in terms of its operation on lists of LSAs. For example, the collection of LSAs that will be retransmitted to an adjacent router until acknowledged are described as a list. Any particular LSA may be on many such lists. An OSPF implementation needs to be able to manipulate these lists, adding and deleting constituent LSAs as necessary.

#### Tasking support

Certain procedures described in this specification invoke other procedures. At times, these other procedures should be executed in-line, that is, before the current procedure is finished. This is indicated in the text by instructions to execute a procedure. At other times, the other procedures are to be executed only when the current procedure has finished. This is indicated by instructions to schedule a task.

### 4.5. Optional OSPF capabilities

The OSPF protocol defines several optional capabilities. A router indicates the optional capabilities that it supports in its OSPF Hello packets, Database Description packets and in its LSAs. This enables routers supporting a mix of optional capabilities to coexist in a single Autonomous System.

Some capabilities must be supported by all routers attached to a specific area. In this case, a router will not accept a neighbor's Hello Packet unless there is a match in reported capabilities (i.e., a capability mismatch prevents a neighbor relationship from forming). An example of this is the ExternalRoutingCapability (see below).

Other capabilities can be negotiated during the Database Exchange process. This is accomplished by specifying the optional capabilities in Database Description packets. A

capability mismatch with a neighbor in this case will result in only a subset of the link state database being exchanged between the two neighbors.

The routing table build process can also be affected by the presence/absence of optional capabilities. For example, since the optional capabilities are reported in LSAs, routers incapable of certain functions can be avoided when building the shortest path tree.

The OSPF optional capabilities defined in this memo are listed below. See Section A.2 for more information.

#### ExternalRoutingCapability

Entire OSPF areas can be configured as "stubs" (see Section 3.6). AS-external-LSAs will not be flooded into stub areas. This capability is represented by the E-bit in the OSPF Options field (see Section A.2). In order to ensure consistent configuration of stub areas, all routers interfacing to such an area must have the E-bit clear in their Hello packets (see Sections 9.5 and 10.5).

## 5. Protocol Data Structures

The OSPF protocol is described herein in terms of its operation on various protocol data structures. The following list comprises the top-level OSPF data structures. Any initialization that needs to be done is noted. OSPF areas, interfaces and neighbors also have associated data structures that are described later in this specification.

#### Router ID

A 32-bit number that uniquely identifies this router in the AS. One possible implementation strategy would be to use the smallest IP interface address belonging to the router. If a router's OSPF Router ID is changed, the router's OSPF software should be restarted before the new Router ID takes effect. In this case the router should flush its self-originated LSAs from the routing domain (see Section 14.1) before restarting, or they will persist for up to MaxAge minutes.

#### Area structures

Each one of the areas to which the router is connected has its own data structure. This data structure describes the working of the basic OSPF algorithm. Remember that each area runs a separate copy of the basic OSPF algorithm.

#### Backbone (area) structure

The OSPF backbone area is responsible for the dissemination of inter-area routing information.

#### Virtual links configured

The virtual links configured with this router as one endpoint. In order to have configured virtual links, the router itself must be an area border router. Virtual links are identified by the Router ID of the other endpoint -- which is another area border router. These two endpoint routers must be attached to a common area, called the virtual link's Transit area. Virtual links are part of the backbone, and behave as if they were unnumbered point-to-point networks between the two routers. A virtual link uses the intra-area routing of its Transit area to forward packets. Virtual links are brought up and down through the building of the shortest-path trees for the Transit area.

#### List of external routes

These are routes to destinations external to the Autonomous System, that have been gained either through direct experience with another routing protocol (such as BGP), or through configuration information, or through a combination of the two (e.g., dynamic external information to be advertised by OSPF with configured metric). Any router having these external routes is called an AS boundary router. These routes are advertised by the router into the OSPF routing domain via AS-external-LSAs.

#### List of AS-external-LSAs

Part of the link-state database. These have originated from the AS boundary routers. They comprise routes to destinations external to the Autonomous System. Note that, if the router is itself an AS boundary router, some of these AS-external-LSAs have been self-originated.



#### The routing table

Derived from the link-state database. Each entry in the routing table is indexed by a destination, and contains the destination's cost and a set of paths to use in forwarding packets to the destination. A path is described by its type and next hop. For more information, see Section 11.

Figure 9 shows the collection of data structures present in a typical router. The router pictured is RT10, from the map in Figure 6. Note that Router RT10 has a virtual link configured to Router RT11, with Area 2 as the link's Transit area. This is indicated by the dashed line in Figure 9. When the virtual link becomes active, through the building of the shortest path tree for Area 2, it becomes an interface to the backbone (see the two backbone interfaces depicted in Figure 9).

## 6. The Area Data Structure

The area data structure contains all the information used to run the basic OSPF routing algorithm. Each area maintains its own link-state database. A network belongs to a single area, and a router interface connects to a single area. Each router adjacency also belongs to a single area.

The OSPF backbone is the special OSPF area responsible for disseminating inter-area routing information.

The area link-state database consists of the collection of router-LSAs, network-LSAs and summary-LSAs that have originated from the area's routers. This information is flooded throughout a single area only. The list of AS-external-LSAs (see Section 5) is also considered to be part of each area's link-state database.

#### Area ID

A 32-bit number identifying the area. The Area ID of 0.0.0.0 is reserved for the backbone.

#### List of area address ranges

In order to aggregate routing information at area boundaries, area address ranges can be employed. Each address range is specified by an [address,mask] pair and a status indication of either Advertise or DoNotAdvertise (see Section 12.4.3).



**List of router-LSAs**

A router-LSA is generated by each router in the area. It describes the state of the router's interfaces to the area.

**List of network-LSAs**

One network-LSA is generated for each transit broadcast and NBMA network in the area. A network-LSA describes the set of routers currently connected to the network.

**List of summary-LSAs**

Summary-LSAs originate from the area's area border routers. They describe routes to destinations internal to the Autonomous System, yet external to the area (i.e., inter-area destinations).

**Shortest-path tree**

The shortest-path tree for the area, with this router itself as root. Derived from the collected router-LSAs and network-LSAs by the Dijkstra algorithm (see Section 16.1).

**TransitCapability**

This parameter indicates whether the area can carry data traffic that neither originates nor terminates in the area itself. This parameter is calculated when the area's shortest-path tree is built (see Section 16.1, where TransitCapability is set to TRUE if and only if there are one or more fully adjacent virtual links using the area as Transit area), and is used as an input to a subsequent step of the routing table build process (see Section 16.3). When an area's TransitCapability is set to TRUE, the area is said to be a "transit area".

**ExternalRoutingCapability**

Whether AS-external-LSAs will be flooded into/throughout the area. This is a configurable parameter. If AS-external-LSAs are excluded from the area, the area is called a "stub". Within stub areas, routing to AS external destinations will be based solely on a default summary route. The backbone cannot be configured as a stub area. Also, virtual links cannot be configured through stub areas. For more information, see Section 3.6.

#### StubDefaultCost

If the area has been configured as a stub area, and the router itself is an area border router, then the StubDefaultCost indicates the cost of the default summary-LSA that the router should advertise into the area. See Section 12.4.3 for more information.

Unless otherwise specified, the remaining sections of this document refer to the operation of the OSPF protocol within a single area.

## 7. Bringing Up Adjacencies

OSPF creates adjacencies between neighboring routers for the purpose of exchanging routing information. Not every two neighboring routers will become adjacent. This section covers the generalities involved in creating adjacencies. For further details consult Section 10.

### 7.1. The Hello Protocol

The Hello Protocol is responsible for establishing and maintaining neighbor relationships. It also ensures that communication between neighbors is bidirectional. Hello packets are sent periodically out all router interfaces. Bidirectional communication is indicated when the router sees itself listed in the neighbor's Hello Packet. On broadcast and NBMA networks, the Hello Protocol elects a Designated Router for the network.

The Hello Protocol works differently on broadcast networks, NBMA networks and Point-to-MultiPoint networks. On broadcast networks, each router advertises itself by periodically multicasting Hello Packets. This allows neighbors to be discovered dynamically. These Hello Packets contain the router's view of the Designated Router's identity, and the list of routers whose Hello Packets have been seen recently.

On NBMA networks some configuration information may be necessary for the operation of the Hello Protocol. Each router that may potentially become Designated Router has a list of all other

routers attached to the network. A router, having Designated Router potential, sends Hello Packets to all other potential Designated Routers when its interface to the NBMA network first becomes operational. This is an attempt to find the Designated Router for the network. If the router itself is elected Designated Router, it begins sending Hello Packets to all other routers attached to the network.

On Point-to-MultiPoint networks, a router sends Hello Packets to all neighbors with which it can communicate directly. These neighbors may be discovered dynamically through a protocol such as Inverse ARP (see [Ref14]), or they may be configured.

After a neighbor has been discovered, bidirectional communication ensured, and (if on a broadcast or NBMA network) a Designated Router elected, a decision is made regarding whether or not an adjacency should be formed with the neighbor (see Section 10.4). If an adjacency is to be formed, the first step is to synchronize the neighbors' link-state databases. This is covered in the next section.

## 7.2. The Synchronization of Databases

In a link-state routing algorithm, it is very important for all routers' link-state databases to stay synchronized. OSPF simplifies this by requiring only adjacent routers to remain synchronized. The synchronization process begins as soon as the routers attempt to bring up the adjacency. Each router describes its database by sending a sequence of Database Description packets to its neighbor. Each Database Description Packet describes a set of LSAs belonging to the router's database. When the neighbor sees an LSA that is more recent than its own database copy, it makes a note that this newer LSA should be requested.

This sending and receiving of Database Description packets is called the "Database Exchange Process". During this process, the two routers form a master/slave relationship. Each Database Description Packet has a sequence number. Database Description Packets sent by the master (polls) are acknowledged by the slave through echoing of the sequence number. Both polls and their

responses contain summaries of link state data. The master is the only one allowed to retransmit Database Description Packets. It does so only at fixed intervals, the length of which is the configured per-interface constant RxmtInterval.

Each Database Description contains an indication that there are more packets to follow --- the M-bit. The Database Exchange Process is over when a router has received and sent Database Description Packets with the M-bit off.

During and after the Database Exchange Process, each router has a list of those LSAs for which the neighbor has more up-to-date instances. These LSAs are requested in Link State Request Packets. Link State Request packets that are not satisfied are retransmitted at fixed intervals of time RxmtInterval. When the Database Description Process has completed and all Link State Requests have been satisfied, the databases are deemed synchronized and the routers are marked fully adjacent. At this time the adjacency is fully functional and is advertised in the two routers' router-LSAs.

The adjacency is used by the flooding procedure as soon as the Database Exchange Process begins. This simplifies database synchronization, and guarantees that it finishes in a predictable period of time.

### 7.3. The Designated Router

Every broadcast and NBMA network has a Designated Router. The Designated Router performs two main functions for the routing protocol:

- o The Designated Router originates a network-LSA on behalf of the network. This LSA lists the set of routers (including the Designated Router itself) currently attached to the network. The Link State ID for this LSA (see Section 12.1.4) is the IP interface address of the Designated Router. The IP network number can then be obtained by using the network's subnet/network mask.

- o The Designated Router becomes adjacent to all other routers on the network. Since the link state databases are synchronized across adjacencies (through adjacency bring-up and then the flooding procedure), the Designated Router plays a central part in the synchronization process.

The Designated Router is elected by the Hello Protocol. A router's Hello Packet contains its Router Priority, which is configurable on a per-interface basis. In general, when a router's interface to a network first becomes functional, it checks to see whether there is currently a Designated Router for the network. If there is, it accepts that Designated Router, regardless of its Router Priority. (This makes it harder to predict the identity of the Designated Router, but ensures that the Designated Router changes less often. See below.) Otherwise, the router itself becomes Designated Router if it has the highest Router Priority on the network. A more detailed (and more accurate) description of Designated Router election is presented in Section 9.4.

The Designated Router is the endpoint of many adjacencies. In order to optimize the flooding procedure on broadcast networks, the Designated Router multicasts its Link State Update Packets to the address AllSPFRouters, rather than sending separate packets over each adjacency.

Section 2 of this document discusses the directed graph representation of an area. Router nodes are labelled with their Router ID. Transit network nodes are actually labelled with the IP address of their Designated Router. It follows that when the Designated Router changes, it appears as if the network node on the graph is replaced by an entirely new node. This will cause the network and all its attached routers to originate new LSAs. Until the link-state databases again converge, some temporary loss of connectivity may result. This may result in ICMP unreachable messages being sent in response to data traffic. For that reason, the Designated Router should change only infrequently. Router Priorities should be configured so that the most dependable router on a network eventually becomes Designated Router.

#### 7.4. The Backup Designated Router

In order to make the transition to a new Designated Router smoother, there is a Backup Designated Router for each broadcast and NBMA network. The Backup Designated Router is also adjacent to all routers on the network, and becomes Designated Router when the previous Designated Router fails. If there were no Backup Designated Router, when a new Designated Router became necessary, new adjacencies would have to be formed between the new Designated Router and all other routers attached to the network. Part of the adjacency forming process is the synchronizing of link-state databases, which can potentially take quite a long time. During this time, the network would not be available for transit data traffic. The Backup Designated Router obviates the need to form these adjacencies, since they already exist. This means the period of disruption in transit traffic lasts only as long as it takes to flood the new LSAs (which announce the new Designated Router).

The Backup Designated Router does not generate a network-LSA for the network. (If it did, the transition to a new Designated Router would be even faster. However, this is a tradeoff between database size and speed of convergence when the Designated Router disappears.)

The Backup Designated Router is also elected by the Hello Protocol. Each Hello Packet has a field that specifies the Backup Designated Router for the network.

In some steps of the flooding procedure, the Backup Designated Router plays a passive role, letting the Designated Router do more of the work. This cuts down on the amount of local routing traffic. See Section 13.3 for more information.

#### 7.5. The graph of adjacencies

An adjacency is bound to the network that the two routers have in common. If two routers have multiple networks in common, they may have multiple adjacencies between them.



One can picture the collection of adjacencies on a network as forming an undirected graph. The vertices consist of routers, with an edge joining two routers if they are adjacent. The graph of adjacencies describes the flow of routing protocol packets, and in particular Link State Update Packets, through the Autonomous System.

Two graphs are possible, depending on whether a Designated Router is elected for the network. On physical point-to-point networks, Point-to-MultiPoint networks and virtual links, neighboring routers become adjacent whenever they can communicate directly. In contrast, on broadcast and NBMA networks only the Designated Router and the Backup Designated Router become adjacent to all other routers attached to the network.

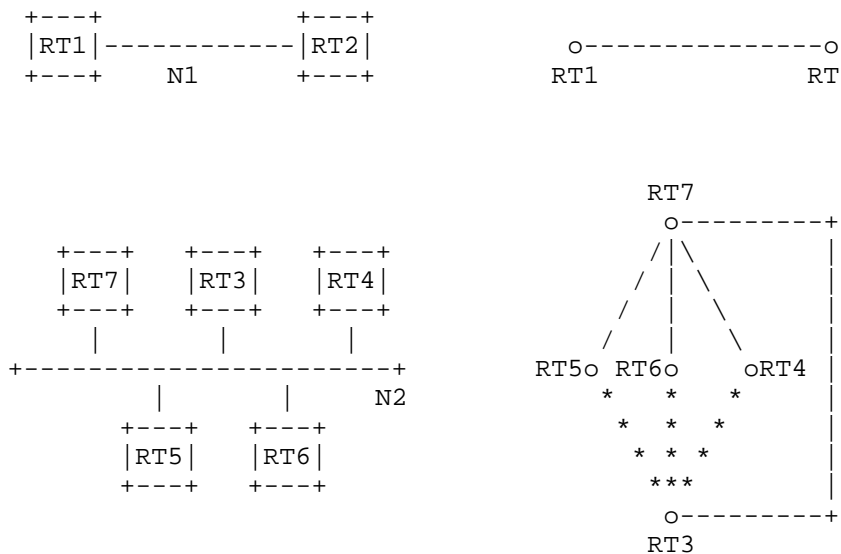

Figure 10: The graph of adjacencies

These graphs are shown in Figure 10. It is assumed that Router RT7 has become the Designated Router, and Router RT3 the Backup Designated Router, for the Network N2. The Backup Designated Router performs a lesser function during the flooding procedure than the Designated Router (see Section 13.3). This is the reason for the dashed lines connecting the Backup Designated Router RT3.

## 8. Protocol Packet Processing

This section discusses the general processing of OSPF routing protocol packets. It is very important that the router link-state databases remain synchronized. For this reason, routing protocol packets should get preferential treatment over ordinary data packets, both in sending and receiving.

Routing protocol packets are sent along adjacencies only (with the exception of Hello packets, which are used to discover the adjacencies). This means that all routing protocol packets travel a single IP hop, except those sent over virtual links.

All routing protocol packets begin with a standard header. The sections below provide details on how to fill in and verify this standard header. Then, for each packet type, the section giving more details on that particular packet type's processing is listed.

### 8.1. Sending protocol packets

When a router sends a routing protocol packet, it fills in the fields of the standard OSPF packet header as follows. For more details on the header format consult Section A.3.1:

Version #

Set to 2, the version number of the protocol as documented in this specification.

Packet type

The type of OSPF packet, such as Link state Update or Hello Packet.

**Packet length**

The length of the entire OSPF packet in bytes, including the standard OSPF packet header.

**Router ID**

The identity of the router itself (who is originating the packet).

**Area ID**

The OSPF area that the packet is being sent into.

**Checksum**

The standard IP 16-bit one's complement checksum of the entire OSPF packet, excluding the 64-bit authentication field. This checksum is calculated as part of the appropriate authentication procedure; for some OSPF authentication types, the checksum calculation is omitted. See Section D.4 for details.

**AuType and Authentication**

Each OSPF packet exchange is authenticated. Authentication types are assigned by the protocol and are documented in Appendix D. A different authentication procedure can be used for each IP network/subnet. AuType indicates the type of authentication procedure in use. The 64-bit authentication field is then for use by the chosen authentication procedure. This procedure should be the last called when forming the packet to be sent. See Section D.4 for details.

The IP destination address for the packet is selected as follows. On physical point-to-point networks, the IP destination is always set to the address AllSPFRouters. On all other network types (including virtual links), the majority of OSPF packets are sent as unicasts, i.e., sent directly to the other end of the adjacency. In this case, the IP destination is just the Neighbor IP address associated with the other end of the adjacency (see Section 10). The only packets not sent as unicasts are on broadcast networks; on these networks Hello packets are sent to the multicast destination AllSPFRouters, the Designated Router and its Backup send both Link State Update

Packets and Link State Acknowledgment Packets to the multicast address AllSPFRouters, while all other routers send both their Link State Update and Link State Acknowledgment Packets to the multicast address AllDRouters.

Retransmissions of Link State Update packets are ALWAYS sent directly to the neighbor. On multi-access networks, this means that retransmissions should be sent to the neighbor's IP address.

The IP source address should be set to the IP address of the sending interface. Interfaces to unnumbered point-to-point networks have no associated IP address. On these interfaces, the IP source should be set to any of the other IP addresses belonging to the router. For this reason, there must be at least one IP address assigned to the router.[2] Note that, for most purposes, virtual links act precisely the same as unnumbered point-to-point networks. However, each virtual link does have an IP interface address (discovered during the routing table build process) which is used as the IP source when sending packets over the virtual link.

For more information on the format of specific OSPF packet types, consult the sections listed in Table 10.

Type	Packet name	detailed section (transmit)
1	Hello	Section 9.5
2	Database description	Section 10.8
3	Link state request	Section 10.9
4	Link state update	Section 13.3
5	Link state ack	Section 13.5

Table 10: Sections describing OSPF protocol packet transmission.

## 8.2. Receiving protocol packets

Whenever a protocol packet is received by the router it is marked with the interface it was received on. For routers that have virtual links configured, it may not be immediately obvious which interface to associate the packet with. For example, consider the Router RT11 depicted in Figure 6. If RT11 receives an OSPF protocol packet on its interface to Network N8, it may want to associate the packet with the interface to Area 2, or with the virtual link to Router RT10 (which is part of the backbone). In the following, we assume that the packet is initially associated with the non-virtual link.[3]

In order for the packet to be accepted at the IP level, it must pass a number of tests, even before the packet is passed to OSPF for processing:

- o The IP checksum must be correct.
- o The packet's IP destination address must be the IP address of the receiving interface, or one of the IP multicast addresses AllSPFRouters or AllDRouters.
- o The IP protocol specified must be OSPF (89).
- o Locally originated packets should not be passed on to OSPF. That is, the source IP address should be examined to make sure this is not a multicast packet that the router itself generated.

Next, the OSPF packet header is verified. The fields specified in the header must match those configured for the receiving interface. If they do not, the packet should be discarded:

- o The version number field must specify protocol version 2.
- o The Area ID found in the OSPF header must be verified. If both of the following cases fail, the packet should be discarded. The Area ID specified in the header must either:

- (1) Match the Area ID of the receiving interface. In this case, the packet has been sent over a single hop. Therefore, the packet's IP source address is required to be on the same network as the receiving interface. This can be verified by comparing the packet's IP source address to the interface's IP address, after masking both addresses with the interface mask. This comparison should not be performed on point-to-point networks. On point-to-point networks, the interface addresses of each end of the link are assigned independently, if they are assigned at all.
  - (2) Indicate the backbone. In this case, the packet has been sent over a virtual link. The receiving router must be an area border router, and the Router ID specified in the packet (the source router) must be the other end of a configured virtual link. The receiving interface must also attach to the virtual link's configured Transit area. If all of these checks succeed, the packet is accepted and is from now on associated with the virtual link (and the backbone area).
- o Packets whose IP destination is AllDRouters should only be accepted if the state of the receiving interface is DR or Backup (see Section 9.1).
  - o The AuType specified in the packet must match the AuType specified for the associated area.
  - o The packet must be authenticated. The authentication procedure is indicated by the setting of AuType (see Appendix D). The authentication procedure may use one or more Authentication keys, which can be configured on a per-interface basis. The authentication procedure may also verify the checksum field in the OSPF packet header (which, when used, is set to the standard IP 16-bit one's complement checksum of the OSPF packet's contents after excluding the 64-bit authentication field). If the authentication procedure fails, the packet should be discarded.

If the packet type is Hello, it should then be further processed by the Hello Protocol (see Section 10.5). All other packet types are sent/received only on adjacencies. This means that the packet must have been sent by one of the router's active neighbors. If the receiving interface connects to a broadcast network, Point-to-MultiPoint network or NBMA network the sender is identified by the IP source address found in the packet's IP header. If the receiving interface connects to a point-to-point network or a virtual link, the sender is identified by the Router ID (source router) found in the packet's OSPF header. The data structure associated with the receiving interface contains the list of active neighbors. Packets not matching any active neighbor are discarded.

At this point all received protocol packets are associated with an active neighbor. For the further input processing of specific packet types, consult the sections listed in Table 11.

Type	Packet name	detailed section (receive)
1	Hello	Section 10.5
2	Database description	Section 10.6
3	Link state request	Section 10.7
4	Link state update	Section 13
5	Link state ack	Section 13.7

Table 11: Sections describing OSPF protocol packet reception.

## 9. The Interface Data Structure

An OSPF interface is the connection between a router and a network. We assume a single OSPF interface to each attached network/subnet, although supporting multiple interfaces on a single network is considered in Appendix F. Each interface structure has at most one IP interface address.

An OSPF interface can be considered to belong to the area that contains the attached network. All routing protocol packets originated by the router over this interface are labelled with the interface's Area ID. One or more router adjacencies may develop over an interface. A router's LSAs reflect the state of its interfaces and their associated adjacencies.

The following data items are associated with an interface. Note that a number of these items are actually configuration for the attached network; such items must be the same for all routers connected to the network.

#### Type

The OSPF interface type is either point-to-point, broadcast, NBMA, Point-to-MultiPoint or virtual link.

#### State

The functional level of an interface. State determines whether or not full adjacencies are allowed to form over the interface. State is also reflected in the router's LSAs.

#### IP interface address

The IP address associated with the interface. This appears as the IP source address in all routing protocol packets originated over this interface. Interfaces to unnumbered point-to-point networks do not have an associated IP address.

#### IP interface mask

Also referred to as the subnet mask, this indicates the portion of the IP interface address that identifies the attached network. Masking the IP interface address with the IP interface mask yields the IP network number of the attached network. On point-to-point networks and virtual links, the IP interface mask is not defined. On these networks, the link itself is not assigned an IP network number, and so the addresses of each side of the link are assigned independently, if they are assigned at all.

#### Area ID

The Area ID of the area to which the attached network belongs. All routing protocol packets originating from the interface are labelled with this Area ID.



**HelloInterval**

The length of time, in seconds, between the Hello packets that the router sends on the interface. Advertised in Hello packets sent out this interface.

**RouterDeadInterval**

The number of seconds before the router's neighbors will declare it down, when they stop hearing the router's Hello Packets. Advertised in Hello packets sent out this interface.

**InfTransDelay**

The estimated number of seconds it takes to transmit a Link State Update Packet over this interface. LSAs contained in the Link State Update packet will have their age incremented by this amount before transmission. This value should take into account transmission and propagation delays; it must be greater than zero.

**Router Priority**

An 8-bit unsigned integer. When two routers attached to a network both attempt to become Designated Router, the one with the highest Router Priority takes precedence. A router whose Router Priority is set to 0 is ineligible to become Designated Router on the attached network. Advertised in Hello packets sent out this interface.

**Hello Timer**

An interval timer that causes the interface to send a Hello packet. This timer fires every HelloInterval seconds. Note that on non-broadcast networks a separate Hello packet is sent to each qualified neighbor.

**Wait Timer**

A single shot timer that causes the interface to exit the Waiting state, and as a consequence select a Designated Router on the network. The length of the timer is RouterDeadInterval seconds.

**List of neighboring routers**

The other routers attached to this network. This list is formed by the Hello Protocol. Adjacencies will be formed to some of

these neighbors. The set of adjacent neighbors can be determined by an examination of all of the neighbors' states.

#### Designated Router

The Designated Router selected for the attached network. The Designated Router is selected on all broadcast and NBMA networks by the Hello Protocol. Two pieces of identification are kept for the Designated Router: its Router ID and its IP interface address on the network. The Designated Router advertises link state for the network; this network-LSA is labelled with the Designated Router's IP address. The Designated Router is initialized to 0.0.0.0, which indicates the lack of a Designated Router.

#### Backup Designated Router

The Backup Designated Router is also selected on all broadcast and NBMA networks by the Hello Protocol. All routers on the attached network become adjacent to both the Designated Router and the Backup Designated Router. The Backup Designated Router becomes Designated Router when the current Designated Router fails. The Backup Designated Router is initialized to 0.0.0.0, indicating the lack of a Backup Designated Router.

#### Interface output cost(s)

The cost of sending a data packet on the interface, expressed in the link state metric. This is advertised as the link cost for this interface in the router-LSA. The cost of an interface must be greater than zero.

#### RxmtInterval

The number of seconds between LSA retransmissions, for adjacencies belonging to this interface. Also used when retransmitting Database Description and Link State Request Packets.

#### AuType

The type of authentication used on the attached network/subnet. Authentication types are defined in Appendix D. All OSPF packet exchanges are authenticated. Different authentication schemes may be used on different networks/subnets.

#### Authentication key

This configured data allows the authentication procedure to generate and/or verify OSPF protocol packets. The Authentication key can be configured on a per-interface basis. For example, if the AuType indicates simple password, the Authentication key would be a 64-bit clear password which is inserted into the OSPF packet header. If instead AuType indicates Cryptographic authentication, then the Authentication key is a shared secret which enables the generation/verification of message digests which are appended to the OSPF protocol packets. When Cryptographic authentication is used, multiple simultaneous keys are supported in order to achieve smooth key transition (see Section D.3).

### 9.1. Interface states

The various states that router interfaces may attain is documented in this section. The states are listed in order of progressing functionality. For example, the inoperative state is listed first, followed by a list of intermediate states before the final, fully functional state is achieved. The specification makes use of this ordering by sometimes making references such as "those interfaces in state greater than X". Figure 11 shows the graph of interface state changes. The arcs of the graph are labelled with the event causing the state change. These events are documented in Section 9.2. The interface state machine is described in more detail in Section 9.3.

#### Down

This is the initial interface state. In this state, the lower-level protocols have indicated that the interface is unusable. No protocol traffic at all will be sent or received on such a interface. In this state, interface parameters should be set to their initial values. All interface timers should be disabled, and there should be no adjacencies associated with the interface.

#### Loopback

In this state, the router's interface to the network is

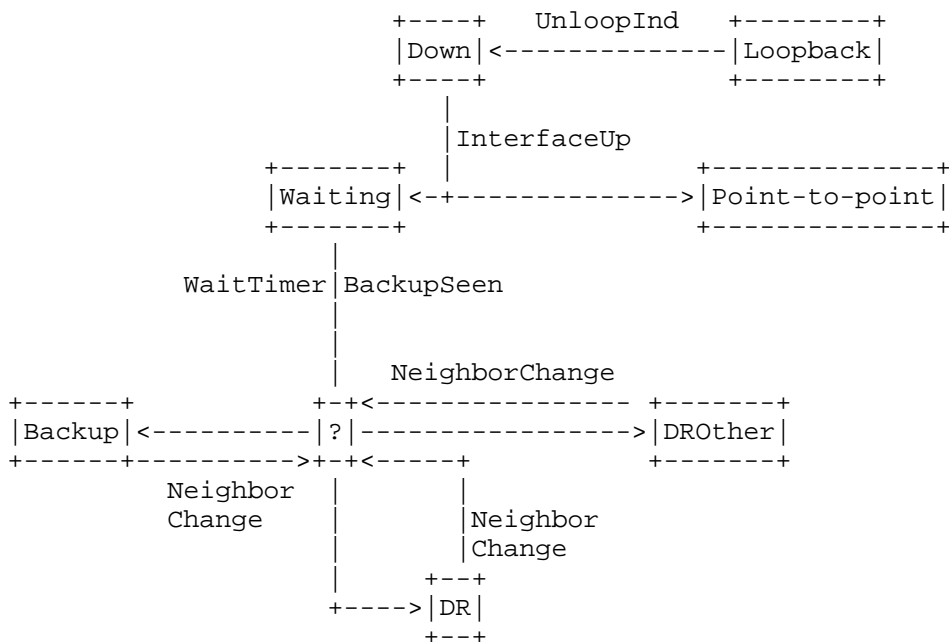

Figure 11: Interface State changes

In addition to the state transitions pictured, Event InterfaceDown always forces Down State, and Event LoopInd always forces Loopback State

looped back. The interface may be looped back in hardware or software. The interface will be unavailable for regular data traffic. However, it may still be desirable to gain information on the quality of this interface, either through sending ICMP pings to the interface or through something like a bit error test. For this reason, IP packets may still be addressed to an interface in Loopback state. To

facilitate this, such interfaces are advertised in router-LSAs as single host routes, whose destination is the IP interface address.[4]

#### Waiting

In this state, the router is trying to determine the identity of the (Backup) Designated Router for the network. To do this, the router monitors the Hello Packets it receives. The router is not allowed to elect a Backup Designated Router nor a Designated Router until it transitions out of Waiting state. This prevents unnecessary changes of (Backup) Designated Router.

#### Point-to-point

In this state, the interface is operational, and connects either to a physical point-to-point network or to a virtual link. Upon entering this state, the router attempts to form an adjacency with the neighboring router. Hello Packets are sent to the neighbor every HelloInterval seconds.

#### DR Other

The interface is to a broadcast or NBMA network on which another router has been selected to be the Designated Router. In this state, the router itself has not been selected Backup Designated Router either. The router forms adjacencies to both the Designated Router and the Backup Designated Router (if they exist).

#### Backup

In this state, the router itself is the Backup Designated Router on the attached network. It will be promoted to Designated Router when the present Designated Router fails. The router establishes adjacencies to all other routers attached to the network. The Backup Designated Router performs slightly different functions during the Flooding Procedure, as compared to the Designated Router (see Section 13.3). See Section 7.4 for more details on the functions performed by the Backup Designated Router.

DR In this state, this router itself is the Designated Router on the attached network. Adjacencies are established to all other routers attached to the network. The router must also

originate a network-LSA for the network node. The network-LSA will contain links to all routers (including the Designated Router itself) attached to the network. See Section 7.3 for more details on the functions performed by the Designated Router.

## 9.2. Events causing interface state changes

State changes can be effected by a number of events. These events are pictured as the labelled arcs in Figure 11. The label definitions are listed below. For a detailed explanation of the effect of these events on OSPF protocol operation, consult Section 9.3.

### InterfaceUp

Lower-level protocols have indicated that the network interface is operational. This enables the interface to transition out of Down state. On virtual links, the interface operational indication is actually a result of the shortest path calculation (see Section 16.7).

### WaitTimer

The Wait Timer has fired, indicating the end of the waiting period that is required before electing a (Backup) Designated Router.

### BackupSeen

The router has detected the existence or non-existence of a Backup Designated Router for the network. This is done in one of two ways. First, an Hello Packet may be received from a neighbor claiming to be itself the Backup Designated Router. Alternatively, an Hello Packet may be received from a neighbor claiming to be itself the Designated Router, and indicating that there is no Backup Designated Router. In either case there must be bidirectional communication with the neighbor, i.e., the router must also appear in the neighbor's Hello Packet. This event signals an end to the Waiting state.

### NeighborChange

There has been a change in the set of bidirectional neighbors associated with the interface. The (Backup) Designated Router needs to be recalculated. The following neighbor changes lead to the NeighborChange event. For an explanation of neighbor states, see Section 10.1.

- o Bidirectional communication has been established to a neighbor. In other words, the state of the neighbor has transitioned to 2-Way or higher.
- o There is no longer bidirectional communication with a neighbor. In other words, the state of the neighbor has transitioned to Init or lower.
- o One of the bidirectional neighbors is newly declaring itself as either Designated Router or Backup Designated Router. This is detected through examination of that neighbor's Hello Packets.
- o One of the bidirectional neighbors is no longer declaring itself as Designated Router, or is no longer declaring itself as Backup Designated Router. This is again detected through examination of that neighbor's Hello Packets.
- o The advertised Router Priority for a bidirectional neighbor has changed. This is again detected through examination of that neighbor's Hello Packets.

### LoopInd

An indication has been received that the interface is now looped back to itself. This indication can be received either from network management or from the lower level protocols.

### UnloopInd

An indication has been received that the interface is no longer looped back. As with the LoopInd event, this

indication can be received either from network management or from the lower level protocols.

#### InterfaceDown

Lower-level protocols indicate that this interface is no longer functional. No matter what the current interface state is, the new interface state will be Down.

### 9.3. The Interface state machine

A detailed description of the interface state changes follows. Each state change is invoked by an event (Section 9.2). This event may produce different effects, depending on the current state of the interface. For this reason, the state machine below is organized by current interface state and received event. Each entry in the state machine describes the resulting new interface state and the required set of additional actions.

When an interface's state changes, it may be necessary to originate a new router-LSA. See Section 12.4 for more details.

Some of the required actions below involve generating events for the neighbor state machine. For example, when an interface becomes inoperative, all neighbor connections associated with the interface must be destroyed. For more information on the neighbor state machine, see Section 10.3.

State(s): Down

Event: InterfaceUp

New state: Depends upon action routine

Action: Start the interval Hello Timer, enabling the periodic sending of Hello packets out the interface. If the attached network is a physical point-to-point network, Point-to-MultiPoint network or virtual link, the interface state transitions to Point-to-Point. Else, if the router is not eligible to become Designated Router the interface state transitions to DR Other.



Otherwise, the attached network is a broadcast or NBMA network and the router is eligible to become Designated Router. In this case, in an attempt to discover the attached network's Designated Router the interface state is set to Waiting and the single shot Wait Timer is started. Additionally, if the network is an NBMA network examine the configured list of neighbors for this interface and generate the neighbor event Start for each neighbor that is also eligible to become Designated Router.

State(s): Waiting

Event: BackupSeen

New state: Depends upon action routine.

Action: Calculate the attached network's Backup Designated Router and Designated Router, as shown in Section 9.4. As a result of this calculation, the new state of the interface will be either DR Other, Backup or DR.

State(s): Waiting

Event: WaitTimer

New state: Depends upon action routine.

Action: Calculate the attached network's Backup Designated Router and Designated Router, as shown in Section 9.4. As a result of this calculation, the new state of the interface will be either DR Other, Backup or DR.

State(s): DR Other, Backup or DR

Event: NeighborChange

New state: Depends upon action routine.

Action: Recalculate the attached network's Backup Designated Router and Designated Router, as shown in Section 9.4. As a result of this calculation, the new state of the interface will be either DR Other, Backup or DR.

State(s): Any State

Event: InterfaceDown

New state: Down

Action: All interface variables are reset, and interface timers disabled. Also, all neighbor connections associated with the interface are destroyed. This is done by generating the event KillNbr on all associated neighbors (see Section 10.2).

State(s): Any State

Event: LoopInd

New state: Loopback

Action: Since this interface is no longer connected to the attached network the actions associated with the above InterfaceDown event are executed.

State(s): Loopback

Event: UnloopInd

New state: Down

Action: No actions are necessary. For example, the interface variables have already been reset upon entering the Loopback state. Note that reception of

an InterfaceUp event is necessary before the interface again becomes fully functional.

#### 9.4. Electing the Designated Router

This section describes the algorithm used for calculating a network's Designated Router and Backup Designated Router. This algorithm is invoked by the Interface state machine. The initial time a router runs the election algorithm for a network, the network's Designated Router and Backup Designated Router are initialized to 0.0.0.0. This indicates the lack of both a Designated Router and a Backup Designated Router.

The Designated Router election algorithm proceeds as follows: Call the router doing the calculation Router X. The list of neighbors attached to the network and having established bidirectional communication with Router X is examined. This list is precisely the collection of Router X's neighbors (on this network) whose state is greater than or equal to 2-Way (see Section 10.1). Router X itself is also considered to be on the list. Discard all routers from the list that are ineligible to become Designated Router. (Routers having Router Priority of 0 are ineligible to become Designated Router.) The following steps are then executed, considering only those routers that remain on the list:

- (1) Note the current values for the network's Designated Router and Backup Designated Router. This is used later for comparison purposes.
- (2) Calculate the new Backup Designated Router for the network as follows. Only those routers on the list that have not declared themselves to be Designated Router are eligible to become Backup Designated Router. If one or more of these routers have declared themselves Backup Designated Router (i.e., they are currently listing themselves as Backup Designated Router, but not as Designated Router, in their Hello Packets) the one having highest Router Priority is declared to be Backup Designated Router. In case of a tie, the one having the highest Router ID is chosen. If no routers have declared themselves Backup Designated Router,

choose the router having highest Router Priority, (again excluding those routers who have declared themselves Designated Router), and again use the Router ID to break ties.

- (3) Calculate the new Designated Router for the network as follows. If one or more of the routers have declared themselves Designated Router (i.e., they are currently listing themselves as Designated Router in their Hello Packets) the one having highest Router Priority is declared to be Designated Router. In case of a tie, the one having the highest Router ID is chosen. If no routers have declared themselves Designated Router, assign the Designated Router to be the same as the newly elected Backup Designated Router.
- (4) If Router X is now newly the Designated Router or newly the Backup Designated Router, or is now no longer the Designated Router or no longer the Backup Designated Router, repeat steps 2 and 3, and then proceed to step 5. For example, if Router X is now the Designated Router, when step 2 is repeated X will no longer be eligible for Backup Designated Router election. Among other things, this will ensure that no router will declare itself both Backup Designated Router and Designated Router.[5]
- (5) As a result of these calculations, the router itself may now be Designated Router or Backup Designated Router. See Sections 7.3 and 7.4 for the additional duties this would entail. The router's interface state should be set accordingly. If the router itself is now Designated Router, the new interface state is DR. If the router itself is now Backup Designated Router, the new interface state is Backup. Otherwise, the new interface state is DR Other.
- (6) If the attached network is an NBMA network, and the router itself has just become either Designated Router or Backup Designated Router, it must start sending Hello Packets to those neighbors that are not eligible to become Designated Router (see Section 9.5.1). This is done by invoking the neighbor event Start for each neighbor having a Router Priority of 0.

- (7) If the above calculations have caused the identity of either the Designated Router or Backup Designated Router to change, the set of adjacencies associated with this interface will need to be modified. Some adjacencies may need to be formed, and others may need to be broken. To accomplish this, invoke the event AdjOK? on all neighbors whose state is at least 2-Way. This will cause their eligibility for adjacency to be reexamined (see Sections 10.3 and 10.4).

The reason behind the election algorithm's complexity is the desire for an orderly transition from Backup Designated Router to Designated Router, when the current Designated Router fails. This orderly transition is ensured through the introduction of hysteresis: no new Backup Designated Router can be chosen until the old Backup accepts its new Designated Router responsibilities.

The above procedure may elect the same router to be both Designated Router and Backup Designated Router, although that router will never be the calculating router (Router X) itself. The elected Designated Router may not be the router having the highest Router Priority, nor will the Backup Designated Router necessarily have the second highest Router Priority. If Router X is not itself eligible to become Designated Router, it is possible that neither a Backup Designated Router nor a Designated Router will be selected in the above procedure. Note also that if Router X is the only attached router that is eligible to become Designated Router, it will select itself as Designated Router and there will be no Backup Designated Router for the network.

#### 9.5. Sending Hello packets

Hello packets are sent out each functioning router interface. They are used to discover and maintain neighbor relationships.[6] On broadcast and NBMA networks, Hello Packets are also used to elect the Designated Router and Backup Designated Router.

The format of an Hello packet is detailed in Section A.3.2. The Hello Packet contains the router's Router Priority (used in choosing the Designated Router), and the interval between Hello Packets sent out the interface (HelloInterval). The Hello Packet also indicates how often a neighbor must be heard from to remain active (RouterDeadInterval). Both HelloInterval and RouterDeadInterval must be the same for all routers attached to a common network. The Hello packet also contains the IP address mask of the attached network (Network Mask). On unnumbered point-to-point networks and on virtual links this field should be set to 0.0.0.0.

The Hello packet's Options field describes the router's optional OSPF capabilities. One optional capability is defined in this specification (see Sections 4.5 and A.2). The E-bit of the Options field should be set if and only if the attached area is capable of processing AS-external-LSAs (i.e., it is not a stub area). If the E-bit is set incorrectly the neighboring routers will refuse to accept the Hello Packet (see Section 10.5). Unrecognized bits in the Hello Packet's Options field should be set to zero.

In order to ensure two-way communication between adjacent routers, the Hello packet contains the list of all routers on the network from which Hello Packets have been seen recently. The Hello packet also contains the router's current choice for Designated Router and Backup Designated Router. A value of 0.0.0.0 in these fields means that one has not yet been selected.

On broadcast networks and physical point-to-point networks, Hello packets are sent every HelloInterval seconds to the IP multicast address AllSPFRouters. On virtual links, Hello packets are sent as unicasts (addressed directly to the other end of the virtual link) every HelloInterval seconds. On Point-to-MultiPoint networks, separate Hello packets are sent to each attached neighbor every HelloInterval seconds. Sending of Hello packets on NBMA networks is covered in the next section.

### 9.5.1. Sending Hello packets on NBMA networks

Static configuration information may be necessary in order for the Hello Protocol to function on non-broadcast networks (see Sections C.5 and C.6). On NBMA networks, every attached router which is eligible to become Designated Router becomes aware of all of its neighbors on the network (either through configuration or by some unspecified mechanism). Each neighbor is labelled with the neighbor's Designated Router eligibility.

The interface state must be at least Waiting for any Hello Packets to be sent out the NBMA interface. Hello Packets are then sent directly (as unicasts) to some subset of a router's neighbors. Sometimes an Hello Packet is sent periodically on a timer; at other times it is sent as a response to a received Hello Packet. A router's hello-sending behavior varies depending on whether the router itself is eligible to become Designated Router.

If the router is eligible to become Designated Router, it must periodically send Hello Packets to all neighbors that are also eligible. In addition, if the router is itself the Designated Router or Backup Designated Router, it must also send periodic Hello Packets to all other neighbors. This means that any two eligible routers are always exchanging Hello Packets, which is necessary for the correct operation of the Designated Router election algorithm. To minimize the number of Hello Packets sent, the number of eligible routers on an NBMA network should be kept small.

If the router is not eligible to become Designated Router, it must periodically send Hello Packets to both the Designated Router and the Backup Designated Router (if they exist). It must also send an Hello Packet in reply to an Hello Packet received from any eligible neighbor (other than the current Designated Router and Backup Designated Router). This is needed to establish an initial bidirectional relationship with any potential Designated Router.

When sending Hello packets periodically to any neighbor, the interval between Hello Packets is determined by the

neighbor's state. If the neighbor is in state Down, Hello Packets are sent every PollInterval seconds. Otherwise, Hello Packets are sent every HelloInterval seconds.

#### 10. The Neighbor Data Structure

An OSPF router converses with its neighboring routers. Each separate conversation is described by a "neighbor data structure". Each conversation is bound to a particular OSPF router interface, and is identified either by the neighboring router's OSPF Router ID or by its Neighbor IP address (see below). Thus if the OSPF router and another router have multiple attached networks in common, multiple conversations ensue, each described by a unique neighbor data structure. Each separate conversation is loosely referred to in the text as being a separate "neighbor".

The neighbor data structure contains all information pertinent to the forming or formed adjacency between the two neighbors. (However, remember that not all neighbors become adjacent.) An adjacency can be viewed as a highly developed conversation between two routers.

##### State

The functional level of the neighbor conversation. This is described in more detail in Section 10.1.

##### Inactivity Timer

A single shot timer whose firing indicates that no Hello Packet has been seen from this neighbor recently. The length of the timer is RouterDeadInterval seconds.

##### Master/Slave

When the two neighbors are exchanging databases, they form a master/slave relationship. The master sends the first Database Description Packet, and is the only part that is allowed to retransmit. The slave can only respond to the master's Database Description Packets. The master/slave relationship is negotiated in state ExStart.



**DD Sequence Number**

The DD Sequence number of the Database Description packet that is currently being sent to the neighbor.

**Last received Database Description packet**

The initialize(I), more (M) and master(MS) bits, Options field, and DD sequence number contained in the last Database Description packet received from the neighbor. Used to determine whether the next Database Description packet received from the neighbor is a duplicate.

**Neighbor ID**

The OSPF Router ID of the neighboring router. The Neighbor ID is learned when Hello packets are received from the neighbor, or is configured if this is a virtual adjacency (see Section C.4).

**Neighbor Priority**

The Router Priority of the neighboring router. Contained in the neighbor's Hello packets, this item is used when selecting the Designated Router for the attached network.

**Neighbor IP address**

The IP address of the neighboring router's interface to the attached network. Used as the Destination IP address when protocol packets are sent as unicasts along this adjacency. Also used in router-LSAs as the Link ID for the attached network if the neighboring router is selected to be Designated Router (see Section 12.4.1). The Neighbor IP address is learned when Hello packets are received from the neighbor. For virtual links, the Neighbor IP address is learned during the routing table build process (see Section 15).

**Neighbor Options**

The optional OSPF capabilities supported by the neighbor. Learned during the Database Exchange process (see Section 10.6). The neighbor's optional OSPF capabilities are also listed in its Hello packets. This enables received Hello Packets to be rejected (i.e., neighbor relationships will not even start to form) if there is a mismatch in certain crucial OSPF capabilities (see Section 10.5). The optional OSPF capabilities are documented in Section 4.5.

#### Neighbor's Designated Router

The neighbor's idea of the Designated Router. If this is the neighbor itself, this is important in the local calculation of the Designated Router. Defined only on broadcast and NBMA networks.

#### Neighbor's Backup Designated Router

The neighbor's idea of the Backup Designated Router. If this is the neighbor itself, this is important in the local calculation of the Backup Designated Router. Defined only on broadcast and NBMA networks.

The next set of variables are lists of LSAs. These lists describe subsets of the area link-state database. This memo defines five distinct types of LSAs, all of which may be present in an area link-state database: router-LSAs, network-LSAs, and Type 3 and 4 summary-LSAs (all stored in the area data structure), and AS-external-LSAs (stored in the global data structure).

#### Link state retransmission list

The list of LSAs that have been flooded but not acknowledged on this adjacency. These will be retransmitted at intervals until they are acknowledged, or until the adjacency is destroyed.

#### Database summary list

The complete list of LSAs that make up the area link-state database, at the moment the neighbor goes into Database Exchange state. This list is sent to the neighbor in Database Description packets.

#### Link state request list

The list of LSAs that need to be received from this neighbor in order to synchronize the two neighbors' link-state databases. This list is created as Database Description packets are received, and is then sent to the neighbor in Link State Request packets. The list is depleted as appropriate Link State Update packets are received.

### 10.1. Neighbor states

The state of a neighbor (really, the state of a conversation being held with a neighboring router) is documented in the following sections. The states are listed in order of progressing functionality. For example, the inoperative state is listed first, followed by a list of intermediate states before the final, fully functional state is achieved. The specification makes use of this ordering by sometimes making references such as "those neighbors/adjacencies in state greater than X". Figures 12 and 13 show the graph of neighbor state changes. The arcs of the graphs are labelled with the event causing the state change. The neighbor events are documented in Section 10.2.

The graph in Figure 12 shows the state changes effected by the Hello Protocol. The Hello Protocol is responsible for neighbor acquisition and maintenance, and for ensuring two way communication between neighbors.

The graph in Figure 13 shows the forming of an adjacency. Not every two neighboring routers become adjacent (see Section 10.4). The adjacency starts to form when the neighbor is in state ExStart. After the two routers discover their master/slave status, the state transitions to Exchange. At this point the neighbor starts to be used in the flooding procedure, and the two neighboring routers begin synchronizing their databases. When this synchronization is finished, the neighbor is in state Full and we say that the two routers are fully adjacent. At this point the adjacency is listed in LSAs.

For a more detailed description of neighbor state changes, together with the additional actions involved in each change, see Section 10.3.

#### Down

This is the initial state of a neighbor conversation. It indicates that there has been no recent information received from the neighbor. On NBMA networks, Hello packets may still be sent to "Down" neighbors, although at a reduced frequency (see Section 9.5.1).

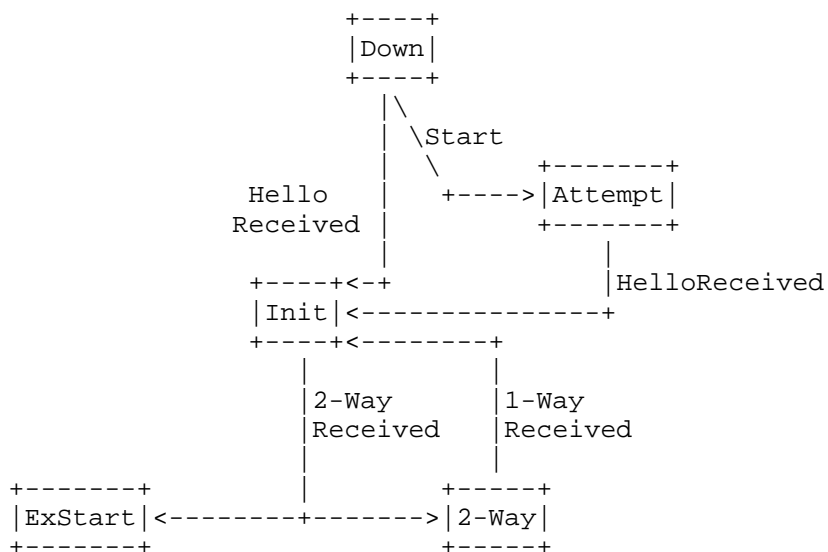

Figure 12: Neighbor state changes (Hello Protocol)

In addition to the state transitions pictured,  
 Event KillNbr always forces Down State,  
 Event InactivityTimer always forces Down State,  
 Event LLDown always forces Down State



neighbors in this state (or higher) are listed in the Hello packets sent from the associated interface.

#### 2-Way

In this state, communication between the two routers is bidirectional. This has been assured by the operation of the Hello Protocol. This is the most advanced state short of beginning adjacency establishment. The (Backup) Designated Router is selected from the set of neighbors in state 2-Way or greater.

#### ExStart

This is the first step in creating an adjacency between the two neighboring routers. The goal of this step is to decide which router is the master, and to decide upon the initial DD sequence number. Neighbor conversations in this state or greater are called adjacencies.

#### Exchange

In this state the router is describing its entire link state database by sending Database Description packets to the neighbor. Each Database Description Packet has a DD sequence number, and is explicitly acknowledged. Only one Database Description Packet is allowed outstanding at any one time. In this state, Link State Request Packets may also be sent asking for the neighbor's more recent LSAs. All adjacencies in Exchange state or greater are used by the flooding procedure. In fact, these adjacencies are fully capable of transmitting and receiving all types of OSPF routing protocol packets.

#### Loading

In this state, Link State Request packets are sent to the neighbor asking for the more recent LSAs that have been discovered (but not yet received) in the Exchange state.

#### Full

In this state, the neighboring routers are fully adjacent. These adjacencies will now appear in router-LSAs and network-LSAs.

## 10.2. Events causing neighbor state changes

State changes can be effected by a number of events. These events are shown in the labels of the arcs in Figures 12 and 13. The label definitions are as follows:

### HelloReceived

An Hello packet has been received from the neighbor.

### Start

This is an indication that Hello Packets should now be sent to the neighbor at intervals of HelloInterval seconds. This event is generated only for neighbors associated with NBMA networks.

### 2-WayReceived

Bidirectional communication has been realized between the two neighboring routers. This is indicated by the router seeing itself in the neighbor's Hello packet.

### NegotiationDone

The Master/Slave relationship has been negotiated, and DD sequence numbers have been exchanged. This signals the start of the sending/receiving of Database Description packets. For more information on the generation of this event, consult Section 10.8.

### ExchangeDone

Both routers have successfully transmitted a full sequence of Database Description packets. Each router now knows what parts of its link state database are out of date. For more information on the generation of this event, consult Section 10.8.

### BadLSReq

A Link State Request has been received for an LSA not contained in the database. This indicates an error in the Database Exchange process.

### Loading Done

Link State Updates have been received for all out-of-date

portions of the database. This is indicated by the Link state request list becoming empty after the Database Exchange process has completed.

#### AdjOK?

A decision must be made as to whether an adjacency should be established/maintained with the neighbor. This event will start some adjacencies forming, and destroy others.

The following events cause well developed neighbors to revert to lesser states. Unlike the above events, these events may occur when the neighbor conversation is in any of a number of states.

#### SeqNumberMismatch

A Database Description packet has been received that either a) has an unexpected DD sequence number, b) unexpectedly has the Init bit set or c) has an Options field differing from the last Options field received in a Database Description packet. Any of these conditions indicate that some error has occurred during adjacency establishment.

#### 1-Way

An Hello packet has been received from the neighbor, in which the router is not mentioned. This indicates that communication with the neighbor is not bidirectional.

#### KillNbr

This is an indication that all communication with the neighbor is now impossible, forcing the neighbor to revert to Down state.

#### InactivityTimer

The inactivity Timer has fired. This means that no Hello packets have been seen recently from the neighbor. The neighbor reverts to Down state.

#### LLDown

This is an indication from the lower level protocols that the neighbor is now unreachable. For example, on an X.25 network this could be indicated by an X.25 clear indication



with appropriate cause and diagnostic fields. This event forces the neighbor into Down state.

### 10.3. The Neighbor state machine

A detailed description of the neighbor state changes follows. Each state change is invoked by an event (Section 10.2). This event may produce different effects, depending on the current state of the neighbor. For this reason, the state machine below is organized by current neighbor state and received event. Each entry in the state machine describes the resulting new neighbor state and the required set of additional actions.

When a neighbor's state changes, it may be necessary to rerun the Designated Router election algorithm. This is determined by whether the interface NeighborChange event is generated (see Section 9.2). Also, if the Interface is in DR state (the router is itself Designated Router), changes in neighbor state may cause a new network-LSA to be originated (see Section 12.4).

When the neighbor state machine needs to invoke the interface state machine, it should be done as a scheduled task (see Section 4.4). This simplifies things, by ensuring that neither state machine will be executed recursively.

State(s): Down

Event: Start

New state: Attempt

Action: Send an Hello Packet to the neighbor (this neighbor is always associated with an NBMA network) and start the Inactivity Timer for the neighbor. The timer's later firing would indicate that communication with the neighbor was not attained.

State(s): Attempt

Event: HelloReceived

New state: Init

Action: Restart the Inactivity Timer for the neighbor, since the neighbor has now been heard from.

State(s): Down

Event: HelloReceived

New state: Init

Action: Start the Inactivity Timer for the neighbor. The timer's later firing would indicate that the neighbor is dead.

State(s): Init or greater

Event: HelloReceived

New state: No state change.

Action: Restart the Inactivity Timer for the neighbor, since the neighbor has again been heard from.

State(s): Init

Event: 2-WayReceived

New state: Depends upon action routine.

Action: Determine whether an adjacency should be established with the neighbor (see Section 10.4). If not, the new neighbor state is 2-Way.

Otherwise (an adjacency should be established) the neighbor state transitions to ExStart. Upon entering this state, the router increments the DD

sequence number in the neighbor data structure. If this is the first time that an adjacency has been attempted, the DD sequence number should be assigned some unique value (like the time of day clock). It then declares itself master (sets the master/slave bit to master), and starts sending Database Description Packets, with the initialize (I), more (M) and master (MS) bits set. This Database Description Packet should be otherwise empty. This Database Description Packet should be retransmitted at intervals of RxmtInterval until the next state is entered (see Section 10.8).

State(s): ExStart

Event: NegotiationDone

New state: Exchange

Action: The router must list the contents of its entire area link state database in the neighbor Database summary list. The area link state database consists of the router-LSAs, network-LSAs and summary-LSAs contained in the area structure, along with the AS-external-LSAs contained in the global structure. AS-external-LSAs are omitted from a virtual neighbor's Database summary list. AS-external-LSAs are omitted from the Database summary list if the area has been configured as a stub (see Section 3.6). LSAs whose age is equal to MaxAge are instead added to the neighbor's Link state retransmission list. A summary of the Database summary list will be sent to the neighbor in Database Description packets. Each Database Description Packet has a DD sequence number, and is explicitly acknowledged. Only one Database Description Packet is allowed outstanding at any one time. For more detail on the sending and receiving of Database Description packets, see Sections 10.8 and 10.6.

State(s): Exchange

Event: ExchangeDone

New state: Depends upon action routine.

Action: If the neighbor Link state request list is empty, the new neighbor state is Full. No other action is required. This is an adjacency's final state.

Otherwise, the new neighbor state is Loading. Start (or continue) sending Link State Request packets to the neighbor (see Section 10.9). These are requests for the neighbor's more recent LSAs (which were discovered but not yet received in the Exchange state). These LSAs are listed in the Link state request list associated with the neighbor.

State(s): Loading

Event: Loading Done

New state: Full

Action: No action required. This is an adjacency's final state.

State(s): 2-Way

Event: AdjOK?

New state: Depends upon action routine.

Action: Determine whether an adjacency should be formed with the neighboring router (see Section 10.4). If not, the neighbor state remains at 2-Way. Otherwise, transition the neighbor state to ExStart and perform the actions associated with the above state machine entry for state Init and event 2-WayReceived.

State(s): ExStart or greater

Event: AdjOK?

New state: Depends upon action routine.

Action: Determine whether the neighboring router should still be adjacent. If yes, there is no state change and no further action is necessary.

Otherwise, the (possibly partially formed) adjacency must be destroyed. The neighbor state transitions to 2-Way. The Link state retransmission list, Database summary list and Link state request list are cleared of LSAs.

State(s): Exchange or greater

Event: SeqNumberMismatch

New state: ExStart

Action: The (possibly partially formed) adjacency is torn down, and then an attempt is made at reestablishment. The neighbor state first transitions to ExStart. The Link state retransmission list, Database summary list and Link state request list are cleared of LSAs. Then the router increments the DD sequence number in the neighbor data structure, declares itself master (sets the master/slave bit to master), and starts sending Database Description Packets, with the initialize (I), more (M) and master (MS) bits set. This Database Description Packet should be otherwise empty (see Section 10.8).

State(s): Exchange or greater

Event: BadLSReq

New state: ExStart

Action: The action for event BadLSReq is exactly the same as for the neighbor event SeqNumberMismatch. The (possibly partially formed) adjacency is torn down, and then an attempt is made at reestablishment. For more information, see the neighbor state machine entry that is invoked when event SeqNumberMismatch is generated in state Exchange or greater.

State(s): Any state

Event: KillNbr

New state: Down

Action: The Link state retransmission list, Database summary list and Link state request list are cleared of LSAs. Also, the Inactivity Timer is disabled.

State(s): Any state

Event: LLDwn

New state: Down

Action: The Link state retransmission list, Database summary list and Link state request list are cleared of LSAs. Also, the Inactivity Timer is disabled.

State(s): Any state

Event: InactivityTimer

New state: Down

Action: The Link state retransmission list, Database summary list and Link state request list are cleared of LSAs.

State(s): 2-Way or greater

Event: 1-WayReceived

New state: Init

Action: The Link state retransmission list, Database summary list and Link state request list are cleared of LSAs.

State(s): 2-Way or greater

Event: 2-WayReceived

New state: No state change.

Action: No action required.

State(s): Init

Event: 1-WayReceived

New state: No state change.

Action: No action required.

#### 10.4. Whether to become adjacent

Adjacencies are established with some subset of the router's neighbors. Routers connected by point-to-point networks, Point-to-MultiPoint networks and virtual links always become adjacent. On broadcast and NBMA networks, all routers become adjacent to both the Designated Router and the Backup Designated Router.

The adjacency-forming decision occurs in two places in the neighbor state machine. First, when bidirectional communication is initially established with the neighbor, and secondly, when the identity of the attached network's (Backup) Designated

Router changes. If the decision is made to not attempt an adjacency, the state of the neighbor communication stops at 2-Way.

An adjacency should be established with a bidirectional neighbor when at least one of the following conditions holds:

- o The underlying network type is point-to-point
- o The underlying network type is Point-to-MultiPoint
- o The underlying network type is virtual link
- o The router itself is the Designated Router
- o The router itself is the Backup Designated Router
- o The neighboring router is the Designated Router
- o The neighboring router is the Backup Designated Router

#### 10.5. Receiving Hello Packets

This section explains the detailed processing of a received Hello Packet. (See Section A.3.2 for the format of Hello packets.) The generic input processing of OSPF packets will have checked the validity of the IP header and the OSPF packet header. Next, the values of the Network Mask, HelloInterval, and RouterDeadInterval fields in the received Hello packet must be checked against the values configured for the receiving interface. Any mismatch causes processing to stop and the packet to be dropped. In other words, the above fields are really describing the attached network's configuration. However, there is one exception to the above rule: on point-to-point networks and on virtual links, the Network Mask in the received Hello Packet should be ignored.

The receiving interface attaches to a single OSPF area (this could be the backbone). The setting of the E-bit found in the Hello Packet's Options field must match this area's



ExternalRoutingCapability. If AS-external-LSAs are not flooded into/throughout the area (i.e, the area is a "stub") the E-bit must be clear in received Hello Packets, otherwise the E-bit must be set. A mismatch causes processing to stop and the packet to be dropped. The setting of the rest of the bits in the Hello Packet's Options field should be ignored.

At this point, an attempt is made to match the source of the Hello Packet to one of the receiving interface's neighbors. If the receiving interface connects to a broadcast, Point-to-MultiPoint or NBMA network the source is identified by the IP source address found in the Hello's IP header. If the receiving interface connects to a point-to-point link or a virtual link, the source is identified by the Router ID found in the Hello's OSPF packet header. The interface's current list of neighbors is contained in the interface's data structure. If a matching neighbor structure cannot be found, (i.e., this is the first time the neighbor has been detected), one is created. The initial state of a newly created neighbor is set to Down.

When receiving an Hello Packet from a neighbor on a broadcast, Point-to-MultiPoint or NBMA network, set the neighbor structure's Neighbor ID equal to the Router ID found in the packet's OSPF header. For these network types, the neighbor structure's Router Priority field, Neighbor's Designated Router field, and Neighbor's Backup Designated Router field are also set equal to the corresponding fields found in the received Hello Packet; changes in these fields should be noted for possible use in the steps below. When receiving an Hello on a point-to-point network (but not on a virtual link) set the neighbor structure's Neighbor IP address to the packet's IP source address.

Now the rest of the Hello Packet is examined, generating events to be given to the neighbor and interface state machines. These state machines are specified either to be executed or scheduled (see Section 4.4). For example, by specifying below that the neighbor state machine be executed in line, several neighbor state transitions may be effected by a single received Hello:

- o Each Hello Packet causes the neighbor state machine to be executed with the event HelloReceived.
- o Then the list of neighbors contained in the Hello Packet is examined. If the router itself appears in this list, the neighbor state machine should be executed with the event 2-WayReceived. Otherwise, the neighbor state machine should be executed with the event 1-WayReceived, and the processing of the packet stops.
- o Next, if a change in the neighbor's Router Priority field was noted, the receiving interface's state machine is scheduled with the event NeighborChange.
- o If the neighbor is both declaring itself to be Designated Router (Hello Packet's Designated Router field = Neighbor IP address) and the Backup Designated Router field in the packet is equal to 0.0.0.0 and the receiving interface is in state Waiting, the receiving interface's state machine is scheduled with the event BackupSeen. Otherwise, if the neighbor is declaring itself to be Designated Router and it had not previously, or the neighbor is not declaring itself Designated Router where it had previously, the receiving interface's state machine is scheduled with the event NeighborChange.
- o If the neighbor is declaring itself to be Backup Designated Router (Hello Packet's Backup Designated Router field = Neighbor IP address) and the receiving interface is in state Waiting, the receiving interface's state machine is scheduled with the event BackupSeen. Otherwise, if the neighbor is declaring itself to be Backup Designated Router and it had not previously, or the neighbor is not declaring itself Backup Designated Router where it had previously, the receiving interface's state machine is scheduled with the event NeighborChange.

On NBMA networks, receipt of an Hello Packet may also cause an Hello Packet to be sent back to the neighbor in response. See Section 9.5.1 for more details.

## 10.6. Receiving Database Description Packets

This section explains the detailed processing of a received Database Description Packet. The incoming Database Description Packet has already been associated with a neighbor and receiving interface by the generic input packet processing (Section 8.2). Whether the Database Description packet should be accepted, and if so, how it should be further processed depends upon the neighbor state.

If a Database Description packet is accepted, the following packet fields should be saved in the corresponding neighbor data structure under "last received Database Description packet": the packet's initialize(I), more (M) and master(MS) bits, Options field, and DD sequence number. If these fields are set identically in two consecutive Database Description packets received from the neighbor, the second Database Description packet is considered to be a "duplicate" in the processing described below.

If the Interface MTU field in the Database Description packet indicates an IP datagram size that is larger than the router can accept on the receiving interface without fragmentation, the Database Description packet is rejected. Otherwise, if the neighbor state is:

Down

The packet should be rejected.

Attempt

The packet should be rejected.

Init

The neighbor state machine should be executed with the event 2-WayReceived. This causes an immediate state change to either state 2-Way or state ExStart. If the new state is ExStart, the processing of the current packet should then continue in this new state by falling through to case ExStart below.

### 2-Way

The packet should be ignored. Database Description Packets are used only for the purpose of bringing up adjacencies.[7]

### ExStart

If the received packet matches one of the following cases, then the neighbor state machine should be executed with the event NegotiationDone (causing the state to transition to Exchange), the packet's Options field should be recorded in the neighbor structure's Neighbor Options field and the packet should be accepted as next in sequence and processed further (see below). Otherwise, the packet should be ignored.

- o The initialize(I), more (M) and master(MS) bits are set, the contents of the packet are empty, and the neighbor's Router ID is larger than the router's own. In this case the router is now Slave. Set the master/slave bit to slave, and set the neighbor data structure's DD sequence number to that specified by the master.
- o The initialize(I) and master(MS) bits are off, the packet's DD sequence number equals the neighbor data structure's DD sequence number (indicating acknowledgment) and the neighbor's Router ID is smaller than the router's own. In this case the router is Master.

### Exchange

Duplicate Database Description packets are discarded by the master, and cause the slave to retransmit the last Database Description packet that it had sent. Otherwise (the packet is not a duplicate):

- o If the state of the MS-bit is inconsistent with the master/slave state of the connection, generate the neighbor event SeqNumberMismatch and stop processing the packet.
- o If the initialize(I) bit is set, generate the neighbor event SeqNumberMismatch and stop processing the packet.

- o If the packet's Options field indicates a different set of optional OSPF capabilities than were previously received from the neighbor (recorded in the Neighbor Options field of the neighbor structure), generate the neighbor event SeqNumberMismatch and stop processing the packet.
- o Database Description packets must be processed in sequence, as indicated by the packets' DD sequence numbers. If the router is master, the next packet received should have DD sequence number equal to the DD sequence number in the neighbor data structure. If the router is slave, the next packet received should have DD sequence number equal to one more than the DD sequence number stored in the neighbor data structure. In either case, if the packet is the next in sequence it should be accepted and its contents processed as specified below.
- o Else, generate the neighbor event SeqNumberMismatch and stop processing the packet.

#### Loading or Full

In this state, the router has sent and received an entire sequence of Database Description Packets. The only packets received should be duplicates (see above). In particular, the packet's Options field should match the set of optional OSPF capabilities previously indicated by the neighbor (stored in the neighbor structure's Neighbor Options field). Any other packets received, including the reception of a packet with the Initialize(I) bit set, should generate the neighbor event SeqNumberMismatch.[8] Duplicates should be discarded by the master. The slave must respond to duplicates by repeating the last Database Description packet that it had sent.

When the router accepts a received Database Description Packet as the next in sequence the packet contents are processed as follows. For each LSA listed, the LSA's LS type is checked for validity. If the LS type is unknown (e.g., not one of the LS types 1-5 defined by this specification), or if this is an AS-external-LSA (LS type = 5) and the neighbor is associated with a

stub area, generate the neighbor event SeqNumberMismatch and stop processing the packet. Otherwise, the router looks up the LSA in its database to see whether it also has an instance of the LSA. If it does not, or if the database copy is less recent (see Section 13.1), the LSA is put on the Link state request list so that it can be requested (immediately or at some later time) in Link State Request Packets.

When the router accepts a received Database Description Packet as the next in sequence, it also performs the following actions, depending on whether it is master or slave:

#### Master

Increments the DD sequence number in the neighbor data structure. If the router has already sent its entire sequence of Database Description Packets, and the just accepted packet has the more bit (M) set to 0, the neighbor event ExchangeDone is generated. Otherwise, it should send a new Database Description to the slave.

#### Slave

Sets the DD sequence number in the neighbor data structure to the DD sequence number appearing in the received packet. The slave must send a Database Description Packet in reply. If the received packet has the more bit (M) set to 0, and the packet to be sent by the slave will also have the M-bit set to 0, the neighbor event ExchangeDone is generated. Note that the slave always generates this event before the master.

### 10.7. Receiving Link State Request Packets

This section explains the detailed processing of received Link State Request packets. Received Link State Request Packets specify a list of LSAs that the neighbor wishes to receive. Link State Request Packets should be accepted when the neighbor is in states Exchange, Loading, or Full. In all other states Link State Request Packets should be ignored.

Each LSA specified in the Link State Request packet should be located in the router's database, and copied into Link State Update packets for transmission to the neighbor. These LSAs should NOT be placed on the Link state retransmission list for the neighbor. If an LSA cannot be found in the database, something has gone wrong with the Database Exchange process, and neighbor event BadLSReq should be generated.

#### 10.8. Sending Database Description Packets

This section describes how Database Description Packets are sent to a neighbor. The Database Description packet's Interface MTU field is set to the size of the largest IP datagram that can be sent out the sending interface, without fragmentation. Common MTUs in use in the Internet can be found in Table 7-1 of [Ref22]. Interface MTU should be set to 0 in Database Description packets sent over virtual links.

The router's optional OSPF capabilities (see Section 4.5) are transmitted to the neighbor in the Options field of the Database Description packet. The router should maintain the same set of optional capabilities throughout the Database Exchange and flooding procedures. If for some reason the router's optional capabilities change, the Database Exchange procedure should be restarted by reverting to neighbor state ExStart. One optional capability is defined in this specification (see Sections 4.5 and A.2). The E-bit should be set if and only if the attached network belongs to a non-stub area. Unrecognized bits in the Options field should be set to zero.

The sending of Database Description packets depends on the neighbor's state. In state ExStart the router sends empty Database Description packets, with the initialize (I), more (M) and master (MS) bits set. These packets are retransmitted every RxmtInterval seconds.

In state Exchange the Database Description Packets actually contain summaries of the link state information contained in the router's database. Each LSA in the area's link-state database (at the time the neighbor transitions into Exchange state) is listed in the neighbor Database summary list. Each new Database

Description Packet copies its DD sequence number from the neighbor data structure and then describes the current top of the Database summary list. Items are removed from the Database summary list when the previous packet is acknowledged.

In state Exchange, the determination of when to send a Database Description packet depends on whether the router is master or slave:

#### Master

Database Description packets are sent when either a) the slave acknowledges the previous Database Description packet by echoing the DD sequence number or b) RxmtInterval seconds elapse without an acknowledgment, in which case the previous Database Description packet is retransmitted.

#### Slave

Database Description packets are sent only in response to Database Description packets received from the master. If the Database Description packet received from the master is new, a new Database Description packet is sent, otherwise the previous Database Description packet is resent.

In states Loading and Full the slave must resend its last Database Description packet in response to duplicate Database Description packets received from the master. For this reason the slave must wait RouterDeadInterval seconds before freeing the last Database Description packet. Reception of a Database Description packet from the master after this interval will generate a SeqNumberMismatch neighbor event.

### 10.9. Sending Link State Request Packets

In neighbor states Exchange or Loading, the Link state request list contains a list of those LSAs that need to be obtained from the neighbor. To request these LSAs, a router sends the neighbor the beginning of the Link state request list, packaged in a Link State Request packet.



When the neighbor responds to these requests with the proper Link State Update packet(s), the Link state request list is truncated and a new Link State Request packet is sent. This process continues until the Link state request list becomes empty. LSAs on the Link state request list that have been requested, but not yet received, are packaged into Link State Request packets for retransmission at intervals of RxmtInterval. There should be at most one Link State Request packet outstanding at any one time.

When the Link state request list becomes empty, and the neighbor state is Loading (i.e., a complete sequence of Database Description packets has been sent to and received from the neighbor), the Loading Done neighbor event is generated.

#### 10.10. An Example

Figure 14 shows an example of an adjacency forming. Routers RT1 and RT2 are both connected to a broadcast network. It is assumed that RT2 is the Designated Router for the network, and that RT2 has a higher Router ID than Router RT1.

The neighbor state changes realized by each router are listed on the sides of the figure.

At the beginning of Figure 14, Router RT1's interface to the network becomes operational. It begins sending Hello Packets, although it doesn't know the identity of the Designated Router or of any other neighboring routers. Router RT2 hears this hello (moving the neighbor to Init state), and in its next Hello Packet indicates that it is itself the Designated Router and that it has heard Hello Packets from RT1. This in turn causes RT1 to go to state ExStart, as it starts to bring up the adjacency.

RT1 begins by asserting itself as the master. When it sees that RT2 is indeed the master (because of RT2's higher Router ID), RT1 transitions to slave state and adopts its neighbor's DD sequence number. Database Description packets are then exchanged, with polls coming from the master (RT2) and responses from the slave (RT1). This sequence of Database Description

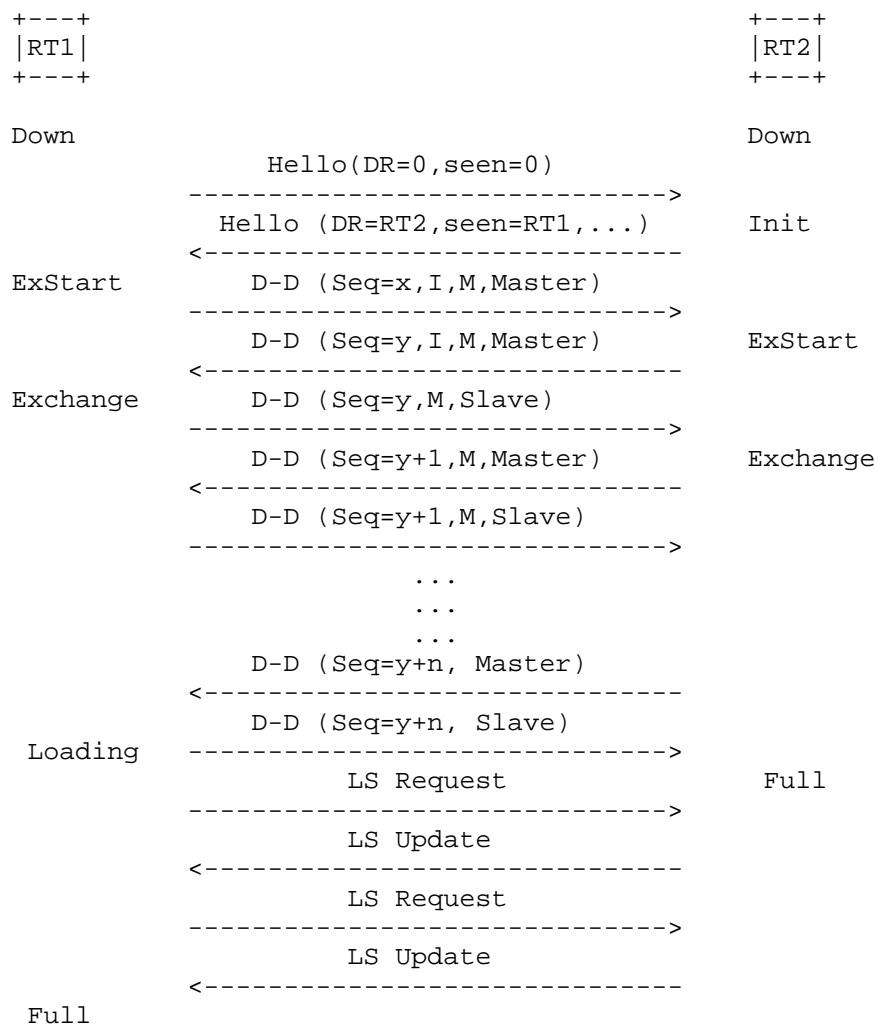

Figure 14: An adjacency bring-up example

Packets ends when both the poll and associated response has the M-bit off.

In this example, it is assumed that RT2 has a completely up to date database. In that case, RT2 goes immediately into Full state. RT1 will go into Full state after updating the necessary parts of its database. This is done by sending Link State Request Packets, and receiving Link State Update Packets in response. Note that, while RT1 has waited until a complete set of Database Description Packets has been received (from RT2) before sending any Link State Request Packets, this need not be the case. RT1 could have interleaved the sending of Link State Request Packets with the reception of Database Description Packets.

## 11. The Routing Table Structure

The routing table data structure contains all the information necessary to forward an IP data packet toward its destination. Each routing table entry describes the collection of best paths to a particular destination. When forwarding an IP data packet, the routing table entry providing the best match for the packet's IP destination is located. The matching routing table entry then provides the next hop towards the packet's destination. OSPF also provides for the existence of a default route (Destination ID = DefaultDestination, Address Mask = 0x00000000). When the default route exists, it matches all IP destinations (although any other matching entry is a better match). Finding the routing table entry that best matches an IP destination is further described in Section 11.1.

There is a single routing table in each router. Two sample routing tables are described in Sections 11.2 and 11.3. The building of the routing table is discussed in Section 16.

The rest of this section defines the fields found in a routing table entry. The first set of fields describes the routing table entry's destination.

#### Destination Type

Destination type is either "network" or "router". Only network entries are actually used when forwarding IP data traffic. Router routing table entries are used solely as intermediate steps in the routing table build process.

A network is a range of IP addresses, to which IP data traffic may be forwarded. This includes IP networks (class A, B, or C), IP subnets, IP supernets and single IP hosts. The default route also falls into this category.

Router entries are kept for area border routers and AS boundary routers. Routing table entries for area border routers are used when calculating the inter-area routes (see Section 16.2), and when maintaining configured virtual links (see Section 15). Routing table entries for AS boundary routers are used when calculating the AS external routes (see Section 16.4).

#### Destination ID

The destination's identifier or name. This depends on the Destination Type. For networks, the identifier is their associated IP address. For routers, the identifier is the OSPF Router ID.[9]

#### Address Mask

Only defined for networks. The network's IP address together with its address mask defines a range of IP addresses. For IP subnets, the address mask is referred to as the subnet mask. For host routes, the mask is "all ones" (0xffffffff).

#### Optional Capabilities

When the destination is a router this field indicates the optional OSPF capabilities supported by the destination router. The only optional capability defined by this specification is the ability to process AS-external-LSAs. For a further discussion of OSPF's optional capabilities, see Section 4.5.

The set of paths to use for a destination may vary based on the OSPF area to which the paths belong. This means that there may be multiple routing table entries for the same destination, depending on the values of the next field.

#### Area

This field indicates the area whose link state information has led to the routing table entry's collection of paths. This is called the entry's associated area. For sets of AS external paths, this field is not defined. For destinations of type "router", there may be separate sets of paths (and therefore separate routing table entries) associated with each of several areas. For example, this will happen when two area border routers share multiple areas in common. For destinations of type "network", only the set of paths associated with the best area (the one providing the preferred route) is kept.

The rest of the routing table entry describes the set of paths to the destination. The following fields pertain to the set of paths as a whole. In other words, each one of the paths contained in a routing table entry is of the same path-type and cost (see below).

#### Path-type

There are four possible types of paths used to route traffic to the destination, listed here in decreasing order of preference: intra-area, inter-area, type 1 external or type 2 external. Intra-area paths indicate destinations belonging to one of the router's attached areas. Inter-area paths are paths to destinations in other OSPF areas. These are discovered through the examination of received summary-LSAs. AS external paths are paths to destinations external to the AS. These are detected through the examination of received AS-external-LSAs.

#### Cost

The link state cost of the path to the destination. For all paths except type 2 external paths this describes the entire path's cost. For Type 2 external paths, this field describes the cost of the portion of the path internal to the AS. This

cost is calculated as the sum of the costs of the path's constituent links.

#### Type 2 cost

Only valid for type 2 external paths. For these paths, this field indicates the cost of the path's external portion. This cost has been advertised by an AS boundary router, and is the most significant part of the total path cost. For example, a type 2 external path with type 2 cost of 5 is always preferred over a path with type 2 cost of 10, regardless of the cost of the two paths' internal components.

#### Link State Origin

Valid only for intra-area paths, this field indicates the LSA (router-LSA or network-LSA) that directly references the destination. For example, if the destination is a transit network, this is the transit network's network-LSA. If the destination is a stub network, this is the router-LSA for the attached router. The LSA is discovered during the shortest-path tree calculation (see Section 16.1). Multiple LSAs may reference the destination, however a tie-breaking scheme always reduces the choice to a single LSA. The Link State Origin field is not used by the OSPF protocol, but it is used by the routing table calculation in OSPF's Multicast routing extensions (MOSPF).

When multiple paths of equal path-type and cost exist to a destination (called elsewhere "equal-cost" paths), they are stored in a single routing table entry. Each one of the "equal-cost" paths is distinguished by the following fields:

#### Next hop

The outgoing router interface to use when forwarding traffic to the destination. On broadcast, Point-to-MultiPoint and NBMA networks, the next hop also includes the IP address of the next router (if any) in the path towards the destination.

#### Advertising router

Valid only for inter-area and AS external paths. This field indicates the Router ID of the router advertising the summary-LSA or AS-external-LSA that led to this path.

### 11.1. Routing table lookup

When an IP data packet is received, an OSPF router finds the routing table entry that best matches the packet's destination. This routing table entry then provides the outgoing interface and next hop router to use in forwarding the packet. This section describes the process of finding the best matching routing table entry.

Before the lookup begins, "discard" routing table entries should be inserted into the routing table for each of the router's active area address ranges (see Section 3.5). (An area range is considered "active" if the range contains one or more networks reachable by intra-area paths.) The destination of a "discard" entry is the set of addresses described by its associated active area address range, and the path type of each "discard" entry is set to "inter-area".[10]

Several routing table entries may match the destination address. In this case, the "best match" is the routing table entry that provides the most specific (longest) match. Another way of saying this is to choose the entry that specifies the narrowest range of IP addresses.[11] For example, the entry for the address/mask pair of (128.185.1.0, 0xfffff00) is more specific than an entry for the pair (128.185.0.0, 0xffff0000). The default route is the least specific match, since it matches all destinations. (Note that for any single routing table entry, multiple paths may be possible. In these cases, the calculations in Sections 16.1, 16.2, and 16.4 always yield the paths having the most preferential path-type, as described in Section 11).

If there is no matching routing table entry, or the best match routing table entry is one of the above "discard" routing table entries, then the packet's IP destination is considered unreachable. Instead of being forwarded, the packet should then be discarded and an ICMP destination unreachable message should be returned to the packet's source.

### 11.2. Sample routing table, without areas

Consider the Autonomous System pictured in Figure 2. No OSPF areas have been configured. A single metric is shown per

outbound interface. The calculation of Router RT6's routing table proceeds as described in Section 2.2. The resulting routing table is shown in Table 12. Destination types are abbreviated: Network as "N", Router as "R".

There are no instances of multiple equal-cost shortest paths in this example. Also, since there are no areas, there are no inter-area paths.

Routers RT5 and RT7 are AS boundary routers. Intra-area routes have been calculated to Routers RT5 and RT7. This allows external routes to be calculated to the destinations advertised by RT5 and RT7 (i.e., Networks N12, N13, N14 and N15). It is assumed all AS-external-LSAs originated by RT5 and RT7 are advertising type 1 external metrics. This results in type 1 external paths being calculated to destinations N12-N15.

### 11.3. Sample routing table, with areas

Consider the previous example, this time split into OSPF areas. An OSPF area configuration is pictured in Figure 6. Router RT4's routing table will be described for this area configuration. Router RT4 has a connection to Area 1 and a backbone connection. This causes Router RT4 to view the AS as the concatenation of the two graphs shown in Figures 7 and 8. The resulting routing table is displayed in Table 13.

Again, Routers RT5 and RT7 are AS boundary routers. Routers RT3, RT4, RT7, RT10 and RT11 are area border routers. Note that there are two routing entries for the area border router RT3, since it has two areas in common with RT4 (Area 1 and the backbone).

Backbone paths have been calculated to all area border routers. These are used when determining the inter-area routes. Note that all of the inter-area routes are associated with the backbone; this is always the case when the calculating router is itself an area border router. Routing information is condensed at area boundaries. In this example, we assume that Area 3 has been defined so that networks N9-N11 and the host route to H1



Type	Dest	Area	Path	Type	Cost	Next Hop(s)	Adv. Router(s)
N	N1	0	intra-area		10	RT3	*
N	N2	0	intra-area		10	RT3	*
N	N3	0	intra-area		7	RT3	*
N	N4	0	intra-area		8	RT3	*
N	Ib	0	intra-area		7	*	*
N	Ia	0	intra-area		12	RT10	*
N	N6	0	intra-area		8	RT10	*
N	N7	0	intra-area		12	RT10	*
N	N8	0	intra-area		10	RT10	*
N	N9	0	intra-area		11	RT10	*
N	N10	0	intra-area		13	RT10	*
N	N11	0	intra-area		14	RT10	*
N	H1	0	intra-area		21	RT10	*
R	RT5	0	intra-area		6	RT5	*
R	RT7	0	intra-area		8	RT10	*
<hr/>							
N	N12	*	type 1 ext.		10	RT10	RT7
N	N13	*	type 1 ext.		14	RT5	RT5
N	N14	*	type 1 ext.		14	RT5	RT5
N	N15	*	type 1 ext.		17	RT10	RT7

Table 12: The routing table for Router RT6  
(no configured areas).

are all condensed to a single route when advertised into the backbone (by Router RT11). Note that the cost of this route is the maximum of the set of costs to its individual components.

There is a virtual link configured between Routers RT10 and RT11. Without this configured virtual link, RT11 would be unable to advertise a route for networks N9-N11 and Host H1 into the backbone, and there would not be an entry for these networks in Router RT4's routing table.

In this example there are two equal-cost paths to Network N12. However, they both use the same next hop (Router RT5).

Router RT4's routing table would improve (i.e., some of the paths in the routing table would become shorter) if an additional virtual link were configured between Router RT4 and Router RT3. The new virtual link would itself be associated with the first entry for area border router RT3 in Table 13 (an intra-area path through Area 1). This would yield a cost of 1 for the virtual link. The routing table entries changes that would be caused by the addition of this virtual link are shown

Type	Dest	Area	Path Type	Cost	Next Hops(s)	Adv. Router(s)
N	N1	1	intra-area	4	RT1	*
N	N2	1	intra-area	4	RT2	*
N	N3	1	intra-area	1	*	*
N	N4	1	intra-area	3	RT3	*
R	RT3	1	intra-area	1	*	*
N	Ib	0	intra-area	22	RT5	*
N	Ia	0	intra-area	27	RT5	*
R	RT3	0	intra-area	21	RT5	*
R	RT5	0	intra-area	8	*	*
R	RT7	0	intra-area	14	RT5	*
R	RT10	0	intra-area	22	RT5	*
R	RT11	0	intra-area	25	RT5	*
N	N6	0	inter-area	15	RT5	RT7
N	N7	0	inter-area	19	RT5	RT7
N	N8	0	inter-area	18	RT5	RT7
N	N9-N11,H1	0	inter-area	36	RT5	RT11
N	N12	*	type 1 ext.	16	RT5	RT5,RT7
N	N13	*	type 1 ext.	16	RT5	RT5
N	N14	*	type 1 ext.	16	RT5	RT5
N	N15	*	type 1 ext.	23	RT5	RT7

Table 13: Router RT4's routing table in the presence of areas.

in Table 14.

## 12. Link State Advertisements (LSAs)

Each router in the Autonomous System originates one or more link state advertisements (LSAs). This memo defines five distinct types of LSAs, which are described in Section 4.3. The collection of LSAs forms the link-state database. Each separate type of LSA has a separate function. Router-LSAs and network-LSAs describe how an area's routers and networks are interconnected. Summary-LSAs provide a way of condensing an area's routing information. AS-external-LSAs provide a way of transparently advertising externally-derived routing information throughout the Autonomous System.

Each LSA begins with a standard 20-byte header. This LSA header is discussed below.

Type	Dest	Area	Path Type	Cost	Next Hop(s)	Adv. Router(s)
N	Ib	0	intra-area	16	RT3	*
N	Ia	0	intra-area	21	RT3	*
R	RT3	0	intra-area	1	*	*
R	RT10	0	intra-area	16	RT3	*
R	RT11	0	intra-area	19	RT3	*
N	N9-N11,H1	0	inter-area	30	RT3	RT11

Table 14: Changes resulting from an additional virtual link.

### 12.1. The LSA Header

The LSA header contains the LS type, Link State ID and Advertising Router fields. The combination of these three fields uniquely identifies the LSA.

There may be several instances of an LSA present in the Autonomous System, all at the same time. It must then be determined which instance is more recent. This determination is made by examining the LS sequence, LS checksum and LS age fields. These fields are also contained in the 20-byte LSA header.

Several of the OSPF packet types list LSAs. When the instance is not important, an LSA is referred to by its LS type, Link State ID and Advertising Router (see Link State Request Packets). Otherwise, the LS sequence number, LS age and LS checksum fields must also be referenced.

A detailed explanation of the fields contained in the LSA header follows.

#### 12.1.1. LS age

This field is the age of the LSA in seconds. It should be processed as an unsigned 16-bit integer. It is set to 0 when the LSA is originated. It must be incremented by InfTransDelay on every hop of the flooding procedure. LSAs are also aged as they are held in each router's database.

The age of an LSA is never incremented past MaxAge. LSAs having age MaxAge are not used in the routing table calculation. When an LSA's age first reaches MaxAge, it is reflooded. An LSA of age MaxAge is finally flushed from the database when it is no longer needed to ensure database synchronization. For more information on the aging of LSAs, consult Section 14.

The LS age field is examined when a router receives two instances of an LSA, both having identical LS sequence numbers and LS checksums. An instance of age MaxAge is then

always accepted as most recent; this allows old LSAs to be flushed quickly from the routing domain. Otherwise, if the ages differ by more than MaxAgeDiff, the instance having the smaller age is accepted as most recent.[12] See Section 13.1 for more details.

#### 12.1.2. Options

The Options field in the LSA header indicates which optional capabilities are associated with the LSA. OSPF's optional capabilities are described in Section 4.5. One optional capability is defined by this specification, represented by the E-bit found in the Options field. The unrecognized bits in the Options field should be set to zero.

The E-bit represents OSPF's ExternalRoutingCapability. This bit should be set in all LSAs associated with the backbone, and all LSAs associated with non-stub areas (see Section 3.6). It should also be set in all AS-external-LSAs. It should be reset in all router-LSAs, network-LSAs and summary-LSAs associated with a stub area. For all LSAs, the setting of the E-bit is for informational purposes only; it does not affect the routing table calculation.

#### 12.1.3. LS type

The LS type field dictates the format and function of the LSA. LSAs of different types have different names (e.g., router-LSAs or network-LSAs). All LSA types defined by this memo, except the AS-external-LSAs (LS type = 5), are flooded throughout a single area only. AS-external-LSAs are flooded throughout the entire Autonomous System, excepting stub areas (see Section 3.6). Each separate LSA type is briefly described below in Table 15.

#### 12.1.4. Link State ID

This field identifies the piece of the routing domain that is being described by the LSA. Depending on the LSA's LS type, the Link State ID takes on the values listed in Table

LS Type	LSA description
1	These are the router-LSAs. They describe the collected states of the router's interfaces. For more information, consult Section 12.4.1.
2	These are the network-LSAs. They describe the set of routers attached to the network. For more information, consult Section 12.4.2.
3 or 4	These are the summary-LSAs. They describe inter-area routes, and enable the condensation of routing information at area borders. Originated by area border routers, the Type 3 summary-LSAs describe routes to networks while the Type 4 summary-LSAs describe routes to AS boundary routers.
5	These are the AS-external-LSAs. Originated by AS boundary routers, they describe routes to destinations external to the Autonomous System. A default route for the Autonomous System can also be described by an AS-external-LSA.

Table 15: OSPF link state advertisements (LSAs).

16.

Actually, for Type 3 summary-LSAs (LS type = 3) and AS-external-LSAs (LS type = 5), the Link State ID may

LS Type	Link State ID
1	The originating router's Router ID.
2	The IP interface address of the network's Designated Router.
3	The destination network's IP address.
4	The Router ID of the described AS boundary router.
5	The destination network's IP address.

Table 16: The LSA's Link State ID.

additionally have one or more of the destination network's "host" bits set. For example, when originating an AS-external-LSA for the network 10.0.0.0 with mask of 255.0.0.0, the Link State ID can be set to anything in the range 10.0.0.0 through 10.255.255.255 inclusive (although 10.0.0.0 should be used whenever possible). The freedom to set certain host bits allows a router to originate separate LSAs for two networks having the same address but different masks. See Appendix E for details.

When the LSA is describing a network (LS type = 2, 3 or 5), the network's IP address is easily derived by masking the Link State ID with the network/subnet mask contained in the body of the LSA. When the LSA is describing a router (LS type = 1 or 4), the Link State ID is always the described router's OSPF Router ID.

When an AS-external-LSA (LS Type = 5) is describing a default route, its Link State ID is set to DefaultDestination (0.0.0.0).

#### 12.1.5. Advertising Router

This field specifies the OSPF Router ID of the LSA's originator. For router-LSAs, this field is identical to the Link State ID field. Network-LSAs are originated by the

network's Designated Router. Summary-LSAs originated by area border routers. AS-external-LSAs are originated by AS boundary routers.

#### 12.1.6. LS sequence number

The sequence number field is a signed 32-bit integer. It is used to detect old and duplicate LSAs. The space of sequence numbers is linearly ordered. The larger the sequence number (when compared as signed 32-bit integers) the more recent the LSA. To describe the sequence number space more precisely, let N refer in the discussion below to the constant  $2^{31}$ .

The sequence number -N (0x80000000) is reserved (and unused). This leaves -N + 1 (0x80000001) as the smallest (and therefore oldest) sequence number; this sequence number is referred to as the constant InitialSequenceNumber. A router uses InitialSequenceNumber the first time it originates any LSA. Afterwards, the LSA's sequence number is incremented each time the router originates a new instance of the LSA. When an attempt is made to increment the sequence number past the maximum value of N - 1 (0x7fffffff; also referred to as MaxSequenceNumber), the current instance of the LSA must first be flushed from the routing domain. This is done by prematurely aging the LSA (see Section 14.1) and reflooding it. As soon as this flood has been acknowledged by all adjacent neighbors, a new instance can be originated with sequence number of InitialSequenceNumber.

The router may be forced to promote the sequence number of one of its LSAs when a more recent instance of the LSA is unexpectedly received during the flooding process. This should be a rare event. This may indicate that an out-of-date LSA, originated by the router itself before its last restart/reload, still exists in the Autonomous System. For more information see Section 13.4.



#### 12.1.7. LS checksum

This field is the checksum of the complete contents of the LSA, excepting the LS age field. The LS age field is excepted so that an LSA's age can be incremented without updating the checksum. The checksum used is the same that is used for ISO connectionless datagrams; it is commonly referred to as the Fletcher checksum. It is documented in Annex B of [Ref6]. The LSA header also contains the length of the LSA in bytes; subtracting the size of the LS age field (two bytes) yields the amount of data to checksum.

The checksum is used to detect data corruption of an LSA. This corruption can occur while an LSA is being flooded, or while it is being held in a router's memory. The LS checksum field cannot take on the value of zero; the occurrence of such a value should be considered a checksum failure. In other words, calculation of the checksum is not optional.

The checksum of an LSA is verified in two cases: a) when it is received in a Link State Update Packet and b) at times during the aging of the link state database. The detection of a checksum failure leads to separate actions in each case. See Sections 13 and 14 for more details.

Whenever the LS sequence number field indicates that two instances of an LSA are the same, the LS checksum field is examined. If there is a difference, the instance with the larger LS checksum is considered to be most recent.[13] See Section 13.1 for more details.

#### 12.2. The link state database

A router has a separate link state database for every area to which it belongs. All routers belonging to the same area have identical link state databases for the area.

The databases for each individual area are always dealt with separately. The shortest path calculation is performed separately for each area (see Section 16). Components of the

area link-state database are flooded throughout the area only. Finally, when an adjacency (belonging to Area A) is being brought up, only the database for Area A is synchronized between the two routers.

The area database is composed of router-LSAs, network-LSAs and summary-LSAs (all listed in the area data structure). In addition, external routes (AS-external-LSAs) are included in all non-stub area databases (see Section 3.6).

An implementation of OSPF must be able to access individual pieces of an area database. This lookup function is based on an LSA's LS type, Link State ID and Advertising Router.[14] There will be a single instance (the most up-to-date) of each LSA in the database. The database lookup function is invoked during the LSA flooding procedure (Section 13) and the routing table calculation (Section 16). In addition, using this lookup function the router can determine whether it has itself ever originated a particular LSA, and if so, with what LS sequence number.

An LSA is added to a router's database when either a) it is received during the flooding process (Section 13) or b) it is originated by the router itself (Section 12.4). An LSA is deleted from a router's database when either a) it has been overwritten by a newer instance during the flooding process (Section 13) or b) the router originates a newer instance of one of its self-originated LSAs (Section 12.4) or c) the LSA ages out and is flushed from the routing domain (Section 14). Whenever an LSA is deleted from the database it must also be removed from all neighbors' Link state retransmission lists (see Section 10).

### 12.3. Representation of TOS

For backward compatibility with previous versions of the OSPF specification ([Ref9]), TOS-specific information can be included in router-LSAs, summary-LSAs and AS-external-LSAs. The encoding of TOS in OSPF LSAs is specified in Table 17. That table relates the OSPF encoding to the IP packet header's TOS field (defined in [Ref12]). The OSPF encoding is expressed as a decimal

integer, and the IP packet header's TOS field is expressed in the binary TOS values used in [Ref12].

OSPF encoding	RFC 1349 TOS values
0	0000 normal service
2	0001 minimize monetary cost
4	0010 maximize reliability
6	0011
8	0100 maximize throughput
10	0101
12	0110
14	0111
16	1000 minimize delay
18	1001
20	1010
22	1011
24	1100
26	1101
28	1110
30	1111

Table 17: Representing TOS in OSPF.

#### 12.4. Originating LSAs

Into any given OSPF area, a router will originate several LSAs. Each router originates a router-LSA. If the router is also the Designated Router for any of the area's networks, it will originate network-LSAs for those networks.

Area border routers originate a single summary-LSA for each known inter-area destination. AS boundary routers originate a single AS-external-LSA for each known AS external destination. Destinations are advertised one at a time so that the change in any single route can be flooded without reflooding the entire collection of routes. During the flooding procedure, many LSAs can be carried by a single Link State Update packet.

As an example, consider Router RT4 in Figure 6. It is an area border router, having a connection to Area 1 and the backbone. Router RT4 originates 5 distinct LSAs into the backbone (one router-LSA, and one summary-LSA for each of the networks N1-N4). Router RT4 will also originate 8 distinct LSAs into Area 1 (one router-LSA and seven summary-LSAs as pictured in Figure 7). If RT4 has been selected as Designated Router for Network N3, it will also originate a network-LSA for N3 into Area 1.

In this same figure, Router RT5 will be originating 3 distinct AS-external-LSAs (one for each of the networks N12-N14). These will be flooded throughout the entire AS, assuming that none of the areas have been configured as stubs. However, if area 3 has been configured as a stub area, the AS-external-LSAs for networks N12-N14 will not be flooded into area 3 (see Section 3.6). Instead, Router RT11 would originate a default summary-LSA that would be flooded throughout area 3 (see Section 12.4.3). This instructs all of area 3's internal routers to send their AS external traffic to RT11.

Whenever a new instance of an LSA is originated, its LS sequence number is incremented, its LS age is set to 0, its LS checksum is calculated, and the LSA is added to the link state database and flooded out the appropriate interfaces. See Section 13.2 for details concerning the installation of the LSA into the link state database. See Section 13.3 for details concerning the flooding of newly originated LSAs.

The ten events that can cause a new instance of an LSA to be originated are:

- (1) The LS age field of one of the router's self-originated LSAs reaches the value LSRefreshTime. In this case, a new instance of the LSA is originated, even though the contents of the LSA (apart from the LSA header) will be the same. This guarantees periodic originations of all LSAs. This periodic updating of LSAs adds robustness to the link state algorithm. LSAs that solely describe unreachable destinations should not be refreshed, but should instead be flushed from the routing domain (see Section 14.1).

When whatever is being described by an LSA changes, a new LSA is originated. However, two instances of the same LSA may not be originated within the time period MinLSInterval. This may require that the generation of the next instance be delayed by up to MinLSInterval. The following events may cause the contents of an LSA to change. These events should cause new originations if and only if the contents of the new LSA would be different:

- (2) An interface's state changes (see Section 9.1). This may mean that it is necessary to produce a new instance of the router-LSA.
- (3) An attached network's Designated Router changes. A new router-LSA should be originated. Also, if the router itself is now the Designated Router, a new network-LSA should be produced. If the router itself is no longer the Designated Router, any network-LSA that it might have originated for the network should be flushed from the routing domain (see Section 14.1).
- (4) One of the neighboring routers changes to/from the FULL state. This may mean that it is necessary to produce a new instance of the router-LSA. Also, if the router is itself the Designated Router for the attached network, a new network-LSA should be produced.

The next four events concern area border routers only:

- (5) An intra-area route has been added/deleted/modified in the routing table. This may cause a new instance of a summary-LSA (for this route) to be originated in each attached area (possibly including the backbone).
- (6) An inter-area route has been added/deleted/modified in the routing table. This may cause a new instance of a summary-LSA (for this route) to be originated in each attached area (but NEVER for the backbone).

- (7) The router becomes newly attached to an area. The router must then originate summary-LSAs into the newly attached area for all pertinent intra-area and inter-area routes in the router's routing table. See Section 12.4.3 for more details.
- (8) When the state of one of the router's configured virtual links changes, it may be necessary to originate a new router-LSA into the virtual link's Transit area (see the discussion of the router-LSA's bit V in Section 12.4.1), as well as originating a new router-LSA into the backbone.

The last two events concern AS boundary routers (and former AS boundary routers) only:

- (9) An external route gained through direct experience with an external routing protocol (like BGP) changes. This will cause an AS boundary router to originate a new instance of an AS-external-LSA.
- (10)  
A router ceases to be an AS boundary router, perhaps after restarting. In this situation the router should flush all AS-external-LSAs that it had previously originated. These LSAs can be flushed via the premature aging procedure specified in Section 14.1.

The construction of each type of LSA is explained in detail below. In general, these sections describe the contents of the LSA body (i.e., the part coming after the 20-byte LSA header). For information concerning the building of the LSA header, see Section 12.1.

#### 12.4.1. Router-LSAs

A router originates a router-LSA for each area that it belongs to. Such an LSA describes the collected states of the router's links to the area. The LSA is flooded throughout the particular area, and no further.



In addition, the router sets bit V in its router-LSA for Area A if and only if the router is the endpoint of one or more fully adjacent virtual links having Area A as their Transit area. The setting of bit V enables other routers in Area A to discover whether the area supports transit traffic (see TransitCapability in Section 6).

The router-LSA then describes the router's working connections (i.e., interfaces or links) to the area. Each link is typed according to the kind of attached network. Each link is also labelled with its Link ID. This Link ID gives a name to the entity that is on the other end of the link. Table 18 summarizes the values used for the Type and Link ID fields.

Link type	Description	Link ID
1	Point-to-point link	Neighbor Router ID
2	Link to transit network	Interface address of Designated Router
3	Link to stub network	IP network number
4	Virtual link	Neighbor Router ID

Table 18: Link descriptions in the router-LSA.

In addition, the Link Data field is specified for each link. This field gives 32 bits of extra information for the link. For links to transit networks, numbered point-to-point links and virtual links, this field specifies the IP interface address of the associated router interface (this is needed by the routing table calculation, see Section 16.1.1). For links to stub networks, this field specifies the stub network's IP address mask. For unnumbered point-to-point links, the Link Data field should be set to the unnumbered interface's MIB-II [Ref8] ifIndex value.



Finally, the cost of using the link for output is specified. The output cost of a link is configurable. With the exception of links to stub networks, the output cost must always be non-zero.

To further describe the process of building the list of link descriptions, suppose a router wishes to build a router-LSA for Area A. The router examines its collection of interface data structures. For each interface, the following steps are taken:

- o If the attached network does not belong to Area A, no links are added to the LSA, and the next interface should be examined.
- o If the state of the interface is Down, no links are added.
- o If the state of the interface is Loopback, add a Type 3 link (stub network) as long as this is not an interface to an unnumbered point-to-point network. The Link ID should be set to the IP interface address, the Link Data set to the mask 0xffffffff (indicating a host route), and the cost set to 0.
- o Otherwise, the link descriptions added to the router-LSA depend on the OSPF interface type. Link descriptions used for point-to-point interfaces are specified in Section 12.4.1.1, for virtual links in Section 12.4.1.2, for broadcast and NBMA interfaces in 12.4.1.3, and for Point-to-MultiPoint interfaces in 12.4.1.4.

After consideration of all the router interfaces, host links are added to the router-LSA by examining the list of attached hosts belonging to Area A. A host route is represented as a Type 3 link (stub network) whose Link ID is the host's IP address, Link Data is the mask of all ones (0xffffffff), and cost the host's configured cost (see Section C.7).

#### 12.4.1.1. Describing point-to-point interfaces

For point-to-point interfaces, one or more link descriptions are added to the router-LSA as follows:

- o If the neighboring router is fully adjacent, add a Type 1 link (point-to-point). The Link ID should be set to the Router ID of the neighboring router. For numbered point-to-point networks, the Link Data should specify the IP interface address. For unnumbered point-to-point networks, the Link Data field should specify the interface's MIB-II [Ref8] ifIndex value. The cost should be set to the output cost of the point-to-point interface.
- o In addition, as long as the state of the interface is "Point-to-Point" (and regardless of the neighboring router state), a Type 3 link (stub network) should be added. There are two forms that this stub link can take:

##### Option 1

Assuming that the neighboring router's IP address is known, set the Link ID of the Type 3 link to the neighbor's IP address, the Link Data to the mask 0xffffffff (indicating a host route), and the cost to the interface's configured output cost.[15]

##### Option 2

If a subnet has been assigned to the point-to-point link, set the Link ID of the Type 3 link to the subnet's IP address, the Link Data to the subnet's mask, and the cost to the interface's configured output cost.[16]

#### 12.4.1.2. Describing broadcast and NBMA interfaces

For operational broadcast and NBMA interfaces, a single link description is added to the router-LSA as follows:

- o If the state of the interface is Waiting, add a Type 3 link (stub network) with Link ID set to the IP network number of the attached network, Link Data set to the attached network's address mask, and cost equal to the interface's configured output cost.
- o Else, there has been a Designated Router elected for the attached network. If the router is fully adjacent to the Designated Router, or if the router itself is Designated Router and is fully adjacent to at least one other router, add a single Type 2 link (transit network) with Link ID set to the IP interface address of the attached network's Designated Router (which may be the router itself), Link Data set to the router's own IP interface address, and cost equal to the interface's configured output cost. Otherwise, add a link as if the interface state were Waiting (see above).

#### 12.4.1.3. Describing virtual links

For virtual links, a link description is added to the router-LSA only when the virtual neighbor is fully adjacent. In this case, add a Type 4 link (virtual link) with Link ID set to the Router ID of the virtual neighbor, Link Data set to the IP interface address associated with the virtual link and cost set to the cost calculated for the virtual link during the routing table calculation (see Section 15).

#### 12.4.1.4. Describing Point-to-MultiPoint interfaces

For operational Point-to-MultiPoint interfaces, one or more link descriptions are added to the router-LSA as follows:

- o A single Type 3 link (stub network) is added with Link ID set to the router's own IP interface address, Link Data set to the mask 0xffffffff (indicating a host route), and cost set to 0.

- o For each fully adjacent neighbor associated with the interface, add an additional Type 1 link (point-to-point) with Link ID set to the Router ID of the neighboring router, Link Data set to the IP interface address and cost equal to the interface's configured output cost.

#### 12.4.1.5. Examples of router-LSAs

Consider the router-LSAs generated by Router RT3, as pictured in Figure 6. The area containing Router RT3 (Area 1) has been redrawn, with actual network addresses, in Figure 15. Assume that the last byte of all of RT3's interface addresses is 3, giving it the interface addresses 192.1.1.3 and 192.1.4.3, and that the other routers have similar addressing schemes. In addition, assume that all links are functional, and that Router IDs are assigned as the smallest IP interface address.

RT3 originates two router-LSAs, one for Area 1 and one for the backbone. Assume that Router RT4 has been selected as the Designated router for network 192.1.1.0. RT3's router-LSA for Area 1 is then shown below. It indicates that RT3 has two connections to Area 1, the first a link to the transit network 192.1.1.0 and the second a link to the stub network 192.1.4.0. Note that the transit network is identified by the IP interface of its Designated Router (i.e., the Link ID = 192.1.1.4 which is the Designated Router RT4's IP interface to 192.1.1.0). Note also that RT3 has indicated that it is an area border router.

```
; RT3's router-LSA for Area 1

LS age = 0                ;always true on origination
Options = (E-bit)        ;
LS type = 1              ;indicates router-LSA
Link State ID = 192.1.1.3 ;RT3's Router ID
Advertising Router = 192.1.1.3 ;RT3's Router ID
bit E = 0                ;not an AS boundary router
```

```

bit B = 1                ;area border router
#links = 2
  Link ID = 192.1.1.4    ;IP address of Desig. Rtr.
  Link Data = 192.1.1.3 ;RT3's IP interface to net
  Type = 2              ;connects to transit network
  # TOS metrics = 0
  metric = 1

  Link ID = 192.1.4.0    ;IP Network number
  Link Data = 0xffffffff ;Network mask
  Type = 3              ;connects to stub network
  # TOS metrics = 0
  metric = 2

```

Next RT3's router-LSA for the backbone is shown. It indicates that RT3 has a single attachment to the backbone. This attachment is via an unnumbered point-to-point link to Router RT6. RT3 has again indicated that it is an area border router.

; RT3's router-LSA for the backbone

```

LS age = 0                ;always true on origination
Options = (E-bit)        ;
LS type = 1              ;indicates router-LSA
Link State ID = 192.1.1.3 ;RT3's router ID
Advertising Router = 192.1.1.3 ;RT3's router ID
bit E = 0                 ;not an AS boundary router
bit B = 1                 ;area border router
#links = 1
  Link ID = 18.10.0.6     ;Neighbor's Router ID
  Link Data = 0.0.0.3     ;MIB-II ifIndex of P-P link
  Type = 1                ;connects to router
  # TOS metrics = 0
  metric = 8

```

#### 12.4.2. Network-LSAs

A network-LSA is generated for every transit broadcast or NBMA network. (A transit network is a network having two or more attached routers). The network-LSA describes all the routers that are attached to the network.

The Designated Router for the network originates the LSA. The Designated Router originates the LSA only if it is fully adjacent to at least one other router on the network. The network-LSA is flooded throughout the area that contains the transit network, and no further. The network-LSA lists those routers that are fully adjacent to the Designated Router; each fully adjacent router is identified by its OSPF Router ID. The Designated Router includes itself in this list.

The Link State ID for a network-LSA is the IP interface address of the Designated Router. This value, masked by the network's address mask (which is also contained in the network-LSA) yields the network's IP address.

A router that has formerly been the Designated Router for a network, but is no longer, should flush the network-LSA that it had previously originated. This LSA is no longer used in the routing table calculation. It is flushed by prematurely incrementing the LSA's age to MaxAge and reflooding (see Section 14.1). In addition, in those rare cases where a router's Router ID has changed, any network-LSAs that were originated with the router's previous Router ID must be flushed. Since the router may have no idea what its previous Router ID might have been, these network-LSAs are indicated by having their Link State ID equal to one of the router's IP interface addresses and their Advertising Router equal to some value other than the router's current Router ID (see Section 13.4 for more details).

#### 12.4.2.1. Examples of network-LSAs

Again consider the area configuration in Figure 6. Network-LSAs are originated for Network N3 in Area 1, Networks N6 and N8 in Area 2, and Network N9 in Area 3. Assuming that Router RT4 has been selected as the Designated Router for Network N3, the following network-LSA is generated by RT4 on behalf of Network N3 (see Figure 15 for the address assignments):

; Network-LSA for Network N3

```
LS age = 0 ;always true on origination
Options = (E-bit) ;
LS type = 2 ;indicates network-LSA
Link State ID = 192.1.1.4 ;IP address of Desig. Rtr.
Advertising Router = 192.1.1.4 ;RT4's Router ID
Network Mask = 0xffffffff00
    Attached Router = 192.1.1.4 ;Router ID
    Attached Router = 192.1.1.1 ;Router ID
    Attached Router = 192.1.1.2 ;Router ID
    Attached Router = 192.1.1.3 ;Router ID
```

#### 12.4.3. Summary-LSAs

The destination described by a summary-LSA is either an IP network, an AS boundary router or a range of IP addresses. Summary-LSAs are flooded throughout a single area only. The destination described is one that is external to the area, yet still belongs to the Autonomous System.

Summary-LSAs are originated by area border routers. The precise summary routes to advertise into an area are determined by examining the routing table structure (see Section 11) in accordance with the algorithm described below. Note that only intra-area routes are advertised into the backbone, while both intra-area and inter-area routes are advertised into the other areas.

To determine which routes to advertise into an attached Area A, each routing table entry is processed as follows. Remember that each routing table entry describes a set of equal-cost best paths to a particular destination:

- o Only Destination Types of network and AS boundary router are advertised in summary-LSAs. If the routing table entry's Destination Type is area border router, examine the next routing table entry.
- o AS external routes are never advertised in summary-LSAs. If the routing table entry has Path-type of type 1 external or type 2 external, examine the next routing table entry.

- o Else, if the area associated with this set of paths is the Area A itself, do not generate a summary-LSA for the route.[17]
- o Else, if the next hops associated with this set of paths belong to Area A itself, do not generate a summary-LSA for the route.[18] This is the logical equivalent of a Distance Vector protocol's split horizon logic.
- o Else, if the routing table cost equals or exceeds the value LSInfinity, a summary-LSA cannot be generated for this route.
- o Else, if the destination of this route is an AS boundary router, a summary-LSA should be originated if and only if the routing table entry describes the preferred path to the AS boundary router (see Step 3 of Section 16.4). If so, a Type 4 summary-LSA is originated for the destination, with Link State ID equal to the AS boundary router's Router ID and metric equal to the routing table entry's cost. Note: these LSAs should not be generated if Area A has been configured as a stub area.
- o Else, the Destination type is network. If this is an inter-area route, generate a Type 3 summary-LSA for the destination, with Link State ID equal to the network's address (if necessary, the Link State ID can also have one or more of the network's host bits set; see Appendix E for details) and metric equal to the routing table cost.
- o The one remaining case is an intra-area route to a network. This means that the network is contained in one of the router's directly attached areas. In general, this information must be condensed before appearing in summary-LSAs. Remember that an area has a configured list of address ranges, each range consisting of an [address,mask] pair and a status indication of either Advertise or DoNotAdvertise. At most a single Type 3 summary-LSA is originated for each range. When the range's status indicates Advertise, a Type 3 summary-LSA is generated with Link State ID equal to the



range's address (if necessary, the Link State ID can also have one or more of the range's "host" bits set; see Appendix E for details) and cost equal to the largest cost of any of the component networks. When the range's status indicates DoNotAdvertise, the Type 3 summary-LSA is suppressed and the component networks remain hidden from other areas.

By default, if a network is not contained in any explicitly configured address range, a Type 3 summary-LSA is generated with Link State ID equal to the network's address (if necessary, the Link State ID can also have one or more of the network's "host" bits set; see Appendix E for details) and metric equal to the network's routing table cost.

If an area is capable of carrying transit traffic (i.e., its TransitCapability is set to TRUE), routing information concerning backbone networks should not be condensed before being summarized into the area. Nor should the advertisement of backbone networks into transit areas be suppressed. In other words, the backbone's configured ranges should be ignored when originating summary-LSAs into transit areas.

If a router advertises a summary-LSA for a destination which then becomes unreachable, the router must then flush the LSA from the routing domain by setting its age to MaxAge and reflooding (see Section 14.1). Also, if the destination is still reachable, yet can no longer be advertised according to the above procedure (e.g., it is now an inter-area route, when it used to be an intra-area route associated with some non-backbone area; it would thus no longer be advertisable to the backbone), the LSA should also be flushed from the routing domain.

#### 12.4.3.1. Originating summary-LSAs into stub areas

The algorithm in Section 12.4.3 is optional when Area A is an OSPF stub area. Area border routers connecting to a stub area can originate summary-LSAs into the area

according to the Section 12.4.3's algorithm, or can choose to originate only a subset of the summary-LSAs, possibly under configuration control. The fewer LSAs originated, the smaller the stub area's link state database, further reducing the demands on its routers' resources. However, omitting LSAs may also lead to sub-optimal inter-area routing, although routing will continue to function.

As specified in Section 12.4.3, Type 4 summary-LSAs (ASBR-summary-LSAs) are never originated into stub areas.

In a stub area, instead of importing external routes each area border router originates a "default summary-LSA" into the area. The Link State ID for the default summary-LSA is set to DefaultDestination, and the metric set to the (per-area) configurable parameter StubDefaultCost. Note that StubDefaultCost need not be configured identically in all of the stub area's area border routers.

#### 12.4.3.2. Examples of summary-LSAs

Consider again the area configuration in Figure 6. Routers RT3, RT4, RT7, RT10 and RT11 are all area border routers, and therefore are originating summary-LSAs. Consider in particular Router RT4. Its routing table was calculated as the example in Section 11.3. RT4 originates summary-LSAs into both the backbone and Area 1. Into the backbone, Router RT4 originates separate LSAs for each of the networks N1-N4. Into Area 1, Router RT4 originates separate LSAs for networks N6-N8 and the AS boundary routers RT5,RT7. It also condenses host routes Ia and Ib into a single summary-LSA. Finally, the routes to networks N9,N10,N11 and Host H1 are advertised by a single summary-LSA. This condensation was originally performed by the router RT11.

These LSAs are illustrated graphically in Figures 7 and 8. Two of the summary-LSAs originated by Router RT4 follow. The actual IP addresses for the networks and routers in question have been assigned in Figure 15.

```
; Summary-LSA for Network N1,  
; originated by Router RT4 into the backbone  
  
LS age = 0                ;always true on origination  
Options = (E-bit)        ;  
LS type = 3              ;Type 3 summary-LSA  
Link State ID = 192.1.2.0 ;N1's IP network number  
Advertising Router = 192.1.1.4 ;RT4's ID  
metric = 4  
  
; Summary-LSA for AS boundary router RT7  
; originated by Router RT4 into Area 1  
  
LS age = 0                ;always true on origination  
Options = (E-bit)        ;  
LS type = 4              ;Type 4 summary-LSA  
Link State ID = Router RT7's ID  
Advertising Router = 192.1.1.4 ;RT4's ID  
metric = 14
```

#### 12.4.4. AS-external-LSAs

AS-external-LSAs describe routes to destinations external to the Autonomous System. Most AS-external-LSAs describe routes to specific external destinations; in these cases the LSA's Link State ID is set to the destination network's IP address (if necessary, the Link State ID can also have one or more of the network's "host" bits set; see Appendix E for details). However, a default route for the Autonomous System can be described in an AS-external-LSA by setting the LSA's Link State ID to DefaultDestination (0.0.0.0). AS-external-LSAs are originated by AS boundary routers. An AS boundary router originates a single AS-external-LSA for each external route that it has learned, either through another routing protocol (such as BGP), or through configuration information.

AS-external-LSAs are the only type of LSAs that are flooded throughout the entire Autonomous System; all other types of LSAs are specific to a single area. However, AS-external-LSAs are not flooded into/throughout stub areas (see Section 3.6). This enables a reduction in link state database size for routers internal to stub areas.

The metric that is advertised for an external route can be one of two types. Type 1 metrics are comparable to the link state metric. Type 2 metrics are assumed to be larger than the cost of any intra-AS path.

If a router advertises an AS-external-LSA for a destination which then becomes unreachable, the router must then flush the LSA from the routing domain by setting its age to MaxAge and reflooding (see Section 14.1).

#### 12.4.4.1. Examples of AS-external-LSAs

Consider once again the AS pictured in Figure 6. There are two AS boundary routers: RT5 and RT7. Router RT5 originates three AS-external-LSAs, for networks N12-N14. Router RT7 originates two AS-external-LSAs, for networks N12 and N15. Assume that RT7 has learned its route to N12 via BGP, and that it wishes to advertise a Type 2 metric to the AS. RT7 would then originate the following LSA for N12:

```
; AS-external-LSA for Network N12,
; originated by Router RT7

LS age = 0                ;always true on origination
Options = (E-bit)        ;
LS type = 5              ;AS-external-LSA
Link State ID = N12's IP network number
Advertising Router = Router RT7's ID
bit E = 1                ;Type 2 metric
metric = 2
Forwarding address = 0.0.0.0
```

In the above example, the forwarding address field has been set to 0.0.0.0, indicating that packets for the external destination should be forwarded to the advertising OSPF router (RT7). This is not always desirable. Consider the example pictured in Figure 16. There are three OSPF routers (RTA, RTB and RTC) connected to a common network. Only one of these routers, RTA, is exchanging BGP information with the non-OSPF router RTX. RTA must then originate AS-external-LSAs for those destinations it has learned from RTX. By using the AS-external-LSA's forwarding address field, RTA can specify that packets for these destinations be forwarded directly to RTX. Without this feature, Routers RTB and RTC would take an extra hop to get to these destinations.

Note that when the forwarding address field is non-zero, it should point to a router belonging to another Autonomous System.

A forwarding address can also be specified for the default route. For example, in figure 16 RTA may want to specify that all externally-destined packets should by default be forwarded to its BGP peer RTX. The resulting AS-external-LSA is pictured below. Note that the Link State ID is set to DefaultDestination.

```
; Default route, originated by Router RTA
; Packets forwarded through RTX

LS age = 0                ;always true on origination
Options = (E-bit)        ;
LS type = 5              ;AS-external-LSA
Link State ID = DefaultDestination ; default route
Advertising Router = Router RTA's ID
bit E = 1                ;Type 2 metric
metric = 1
Forwarding address = RTX's IP address
```

In figure 16, suppose instead that both RTA and RTB exchange BGP information with RTX. In this case,

RTA and RTB would originate the same set of AS-external-LSAs. These LSAs, if they specify the same metric, would be functionally equivalent since they would specify the same destination and forwarding address (RTX). This leads to a clear duplication of effort. If only one of RTA or RTB originated the set of AS-external-LSAs, the routing would remain the same, and the size of the link state database would decrease. However, it must be unambiguously defined as to which router originates the LSAs (otherwise neither may, or the identity of the originator may oscillate). The following rule is thereby established: if two routers, both reachable from one another, originate functionally equivalent AS-external-LSAs (i.e., same destination, cost and non-zero forwarding address), then the LSA originated by the router having the highest OSPF Router ID is used. The router having the lower OSPF Router ID can then flush its LSA. Flushing an LSA is discussed in Section 14.1.

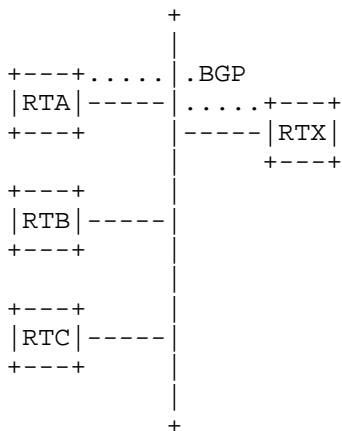

Figure 16: Forwarding address example

### 13. The Flooding Procedure

Link State Update packets provide the mechanism for flooding LSAs. A Link State Update packet may contain several distinct LSAs, and floods each LSA one hop further from its point of origination. To make the flooding procedure reliable, each LSA must be acknowledged separately. Acknowledgments are transmitted in Link State Acknowledgment packets. Many separate acknowledgments can also be grouped together into a single packet.

The flooding procedure starts when a Link State Update packet has been received. Many consistency checks have been made on the received packet before being handed to the flooding procedure (see Section 8.2). In particular, the Link State Update packet has been associated with a particular neighbor, and a particular area. If the neighbor is in a lesser state than Exchange, the packet should be dropped without further processing.

All types of LSAs, other than AS-external-LSAs, are associated with a specific area. However, LSAs do not contain an area field. An LSA's area must be deduced from the Link State Update packet header.

For each LSA contained in a Link State Update packet, the following steps are taken:

- (1) Validate the LSA's LS checksum. If the checksum turns out to be invalid, discard the LSA and get the next one from the Link State Update packet.
- (2) Examine the LSA's LS type. If the LS type is unknown, discard the LSA and get the next one from the Link State Update Packet. This specification defines LS types 1-5 (see Section 4.3).
- (3) Else if this is an AS-external-LSA (LS type = 5), and the area has been configured as a stub area, discard the LSA and get the next one from the Link State Update Packet. AS-external-LSAs are not flooded into/throughout stub areas (see Section 3.6).
- (4) Else if the LSA's LS age is equal to MaxAge, and there is currently no instance of the LSA in the router's link state database, and none of router's neighbors are in states Exchange

or Loading, then take the following actions: a) Acknowledge the receipt of the LSA by sending a Link State Acknowledgment packet back to the sending neighbor (see Section 13.5), and b) Discard the LSA and examine the next LSA (if any) listed in the Link State Update packet.

- (5) Otherwise, find the instance of this LSA that is currently contained in the router's link state database. If there is no database copy, or the received LSA is more recent than the database copy (see Section 13.1 below for the determination of which LSA is more recent) the following steps must be performed:
  - (a) If there is already a database copy, and if the database copy was received via flooding and installed less than MinLSArrival seconds ago, discard the new LSA (without acknowledging it) and examine the next LSA (if any) listed in the Link State Update packet.
  - (b) Otherwise immediately flood the new LSA out some subset of the router's interfaces (see Section 13.3). In some cases (e.g., the state of the receiving interface is DR and the LSA was received from a router other than the Backup DR) the LSA will be flooded back out the receiving interface. This occurrence should be noted for later use by the acknowledgment process (Section 13.5).
  - (c) Remove the current database copy from all neighbors' Link state retransmission lists.
  - (d) Install the new LSA in the link state database (replacing the current database copy). This may cause the routing table calculation to be scheduled. In addition, timestamp the new LSA with the current time (i.e., the time it was received). The flooding procedure cannot overwrite the newly installed LSA until MinLSArrival seconds have elapsed. The LSA installation process is discussed further in Section 13.2.
  - (e) Possibly acknowledge the receipt of the LSA by sending a Link State Acknowledgment packet back out the receiving interface. This is explained below in Section 13.5.



- (f) If this new LSA indicates that it was originated by the receiving router itself (i.e., is considered a self-originated LSA), the router must take special action, either updating the LSA or in some cases flushing it from the routing domain. For a description of how self-originated LSAs are detected and subsequently handled, see Section 13.4.
- (6) Else, if there is an instance of the LSA on the sending neighbor's Link state request list, an error has occurred in the Database Exchange process. In this case, restart the Database Exchange process by generating the neighbor event BadLSReq for the sending neighbor and stop processing the Link State Update packet.
- (7) Else, if the received LSA is the same instance as the database copy (i.e., neither one is more recent) the following two steps should be performed:
  - (a) If the LSA is listed in the Link state retransmission list for the receiving adjacency, the router itself is expecting an acknowledgment for this LSA. The router should treat the received LSA as an acknowledgment by removing the LSA from the Link state retransmission list. This is termed an "implied acknowledgment". Its occurrence should be noted for later use by the acknowledgment process (Section 13.5).
  - (b) Possibly acknowledge the receipt of the LSA by sending a Link State Acknowledgment packet back out the receiving interface. This is explained below in Section 13.5.
- (8) Else, the database copy is more recent. If the database copy has LS age equal to MaxAge and LS sequence number equal to MaxSequenceNumber, simply discard the received LSA without acknowledging it. (In this case, the LSA's LS sequence number is wrapping, and the MaxSequenceNumber LSA must be completely flushed before any new LSA instance can be introduced). Otherwise, as long as the database copy has not been sent in a Link State Update within the last MinLSArrival seconds, send the database copy back to the sending neighbor, encapsulated within a Link State Update Packet. The Link State Update Packet should be sent directly to the neighbor. In so doing, do not put the

database copy of the LSA on the neighbor's link state retransmission list, and do not acknowledge the received (less recent) LSA instance.

### 13.1. Determining which LSA is newer

When a router encounters two instances of an LSA, it must determine which is more recent. This occurred above when comparing a received LSA to its database copy. This comparison must also be done during the Database Exchange procedure which occurs during adjacency bring-up.

An LSA is identified by its LS type, Link State ID and Advertising Router. For two instances of the same LSA, the LS sequence number, LS age, and LS checksum fields are used to determine which instance is more recent:

- o The LSA having the newer LS sequence number is more recent. See Section 12.1.6 for an explanation of the LS sequence number space. If both instances have the same LS sequence number, then:
- o If the two instances have different LS checksums, then the instance having the larger LS checksum (when considered as a 16-bit unsigned integer) is considered more recent.
- o Else, if only one of the instances has its LS age field set to MaxAge, the instance of age MaxAge is considered to be more recent.
- o Else, if the LS age fields of the two instances differ by more than MaxAgeDiff, the instance having the smaller (younger) LS age is considered to be more recent.
- o Else, the two instances are considered to be identical.

### 13.2. Installing LSAs in the database

Installing a new LSA in the database, either as the result of flooding or a newly self-originated LSA, may cause the OSPF routing table structure to be recalculated. The contents of the new LSA should be compared to the old instance, if present. If there is no difference, there is no need to recalculate the routing table. When comparing an LSA to its previous instance, the following are all considered to be differences in contents:

- o The LSA's Options field has changed.
- o One of the LSA instances has LS age set to MaxAge, and the other does not.
- o The length field in the LSA header has changed.
- o The body of the LSA (i.e., anything outside the 20-byte LSA header) has changed. Note that this excludes changes in LS Sequence Number and LS Checksum.

If the contents are different, the following pieces of the routing table must be recalculated, depending on the new LSA's LS type field:

#### Router-LSAs and network-LSAs

The entire routing table must be recalculated, starting with the shortest path calculations for each area (not just the area whose link-state database has changed). The reason that the shortest path calculation cannot be restricted to the single changed area has to do with the fact that AS boundary routers may belong to multiple areas. A change in the area currently providing the best route may force the router to use an intra-area route provided by a different area.[19]

#### Summary-LSAs

The best route to the destination described by the summary-LSA must be recalculated (see Section 16.5). If this destination is an AS boundary router, it may also be necessary to re-examine all the AS-external-LSAs.

#### AS-external-LSAs

The best route to the destination described by the AS-external-LSA must be recalculated (see Section 16.6).

Also, any old instance of the LSA must be removed from the database when the new LSA is installed. This old instance must also be removed from all neighbors' Link state retransmission lists (see Section 10).

### 13.3. Next step in the flooding procedure

When a new (and more recent) LSA has been received, it must be flooded out some set of the router's interfaces. This section describes the second part of flooding procedure (the first part being the processing that occurred in Section 13), namely, selecting the outgoing interfaces and adding the LSA to the appropriate neighbors' Link state retransmission lists. Also included in this part of the flooding procedure is the maintenance of the neighbors' Link state request lists.

This section is equally applicable to the flooding of an LSA that the router itself has just originated (see Section 12.4). For these LSAs, this section provides the entirety of the flooding procedure (i.e., the processing of Section 13 is not performed, since, for example, the LSA has not been received from a neighbor and therefore does not need to be acknowledged).

Depending upon the LSA's LS type, the LSA can be flooded out only certain interfaces. These interfaces, defined by the following, are called the eligible interfaces:

#### AS-external-LSAs (LS Type = 5)

AS-external-LSAs are flooded throughout the entire AS, with the exception of stub areas (see Section 3.6). The eligible interfaces are all the router's interfaces, excluding virtual links and those interfaces attaching to stub areas.

#### All other LS types

All other types are specific to a single area (Area A). The

eligible interfaces are all those interfaces attaching to the Area A. If Area A is the backbone, this includes all the virtual links.

Link state databases must remain synchronized over all adjacencies associated with the above eligible interfaces. This is accomplished by executing the following steps on each eligible interface. It should be noted that this procedure may decide not to flood an LSA out a particular interface, if there is a high probability that the attached neighbors have already received the LSA. However, in these cases the flooding procedure must be absolutely sure that the neighbors eventually do receive the LSA, so the LSA is still added to each adjacency's Link state retransmission list. For each eligible interface:

- (1) Each of the neighbors attached to this interface are examined, to determine whether they must receive the new LSA. The following steps are executed for each neighbor:
  - (a) If the neighbor is in a lesser state than Exchange, it does not participate in flooding, and the next neighbor should be examined.
  - (b) Else, if the adjacency is not yet full (neighbor state is Exchange or Loading), examine the Link state request list associated with this adjacency. If there is an instance of the new LSA on the list, it indicates that the neighboring router has an instance of the LSA already. Compare the new LSA to the neighbor's copy:
    - o If the new LSA is less recent, then examine the next neighbor.
    - o If the two copies are the same instance, then delete the LSA from the Link state request list, and examine the next neighbor.[20]
    - o Else, the new LSA is more recent. Delete the LSA from the Link state request list.

- (c) If the new LSA was received from this neighbor, examine the next neighbor.
  - (d) At this point we are not positive that the neighbor has an up-to-date instance of this new LSA. Add the new LSA to the Link state retransmission list for the adjacency. This ensures that the flooding procedure is reliable; the LSA will be retransmitted at intervals until an acknowledgment is seen from the neighbor.
- (2) The router must now decide whether to flood the new LSA out this interface. If in the previous step, the LSA was NOT added to any of the Link state retransmission lists, there is no need to flood the LSA out the interface and the next interface should be examined.
  - (3) If the new LSA was received on this interface, and it was received from either the Designated Router or the Backup Designated Router, chances are that all the neighbors have received the LSA already. Therefore, examine the next interface.
  - (4) If the new LSA was received on this interface, and the interface state is Backup (i.e., the router itself is the Backup Designated Router), examine the next interface. The Designated Router will do the flooding on this interface. However, if the Designated Router fails the router (i.e., the Backup Designated Router) will end up retransmitting the updates.
  - (5) If this step is reached, the LSA must be flooded out the interface. Send a Link State Update packet (including the new LSA as contents) out the interface. The LSA's LS age must be incremented by InfTransDelay (which must be > 0) when it is copied into the outgoing Link State Update packet (until the LS age field reaches the maximum value of MaxAge).

On broadcast networks, the Link State Update packets are multicast. The destination IP address specified for the Link State Update Packet depends on the state of the interface. If the interface state is DR or Backup, the

address AllSPFRouters should be used. Otherwise, the address AllDRouters should be used.

On non-broadcast networks, separate Link State Update packets must be sent, as unicasts, to each adjacent neighbor (i.e., those in state Exchange or greater). The destination IP addresses for these packets are the neighbors' IP addresses.

#### 13.4. Receiving self-originated LSAs

It is a common occurrence for a router to receive self-originated LSAs via the flooding procedure. A self-originated LSA is detected when either 1) the LSA's Advertising Router is equal to the router's own Router ID or 2) the LSA is a network-LSA and its Link State ID is equal to one of the router's own IP interface addresses.

However, if the received self-originated LSA is newer than the last instance that the router actually originated, the router must take special action. The reception of such an LSA indicates that there are LSAs in the routing domain that were originated by the router before the last time it was restarted. In most cases, the router must then advance the LSA's LS sequence number one past the received LS sequence number, and originate a new instance of the LSA.

It may be the case the router no longer wishes to originate the received LSA. Possible examples include: 1) the LSA is a summary-LSA or AS-external-LSA and the router no longer has an (advertisable) route to the destination, 2) the LSA is a network-LSA but the router is no longer Designated Router for the network or 3) the LSA is a network-LSA whose Link State ID is one of the router's own IP interface addresses but whose Advertising Router is not equal to the router's own Router ID (this latter case should be rare, and it indicates that the router's Router ID has changed since originating the LSA). In all these cases, instead of updating the LSA, the LSA should be flushed from the routing domain by incrementing the received LSA's LS age to MaxAge and reflooding (see Section 14.1).

### 13.5. Sending Link State Acknowledgment packets

Each newly received LSA must be acknowledged. This is usually done by sending Link State Acknowledgment packets. However, acknowledgments can also be accomplished implicitly by sending Link State Update packets (see step 7a of Section 13).

Many acknowledgments may be grouped together into a single Link State Acknowledgment packet. Such a packet is sent back out the interface which received the LSAs. The packet can be sent in one of two ways: delayed and sent on an interval timer, or sent directly to a particular neighbor. The particular acknowledgment strategy used depends on the circumstances surrounding the receipt of the LSA.

Sending delayed acknowledgments accomplishes several things: 1) it facilitates the packaging of multiple acknowledgments in a single Link State Acknowledgment packet, 2) it enables a single Link State Acknowledgment packet to indicate acknowledgments to several neighbors at once (through multicasting) and 3) it randomizes the Link State Acknowledgment packets sent by the various routers attached to a common network. The fixed interval between a router's delayed transmissions must be short (less than RxmtInterval) or needless retransmissions will ensue.

Direct acknowledgments are sent directly to a particular neighbor in response to the receipt of duplicate LSAs. Direct acknowledgments are sent immediately when the duplicate is received. On multi-access networks, these acknowledgments are sent directly to the neighbor's IP address.

The precise procedure for sending Link State Acknowledgment packets is described in Table 19. The circumstances surrounding the receipt of the LSA are listed in the left column. The acknowledgment action then taken is listed in one of the two right columns. This action depends on the state of the concerned interface; interfaces in state Backup behave differently from interfaces in all other states. Delayed acknowledgments must be delivered to all adjacent routers associated with the interface. On broadcast networks, this is accomplished by sending the delayed Link State Acknowledgment packets as multicasts. The Destination IP address used depends



Circumstances	Action taken in state	
	Backup	All other states
LSA has been flooded back out receiving interface (see Section 13, step 5b).	No acknowledgment sent.	No acknowledgment sent.
LSA is more recent than database copy, but was not flooded back out receiving interface	Delayed acknowledgment sent if advertisement received from Designated Router, otherwise do nothing	Delayed acknowledgment sent.
LSA is a duplicate, and was treated as an implied acknowledgment (see Section 13, step 7a).	Delayed acknowledgment sent if advertisement received from Designated Router, otherwise do nothing	No acknowledgment sent.
LSA is a duplicate, and was not treated as an implied acknowledgment.	Direct acknowledgment sent.	Direct acknowledgment sent.
LSA's LS age is equal to MaxAge, and there is no current instance of the LSA in the link state database, and none of router's neighbors are in states Exchange	Direct acknowledgment sent.	Direct acknowledgment sent.

or Loading (see Section 13, step 4).

Table 19: Sending link state acknowledgements.

on the state of the interface. If the interface state is DR or Backup, the destination AllSPFRouters is used. In all other states, the destination AllDRouters is used. On non-broadcast networks, delayed Link State Acknowledgment packets must be unicast separately over each adjacency (i.e., neighbor whose state is  $\geq$  Exchange).

The reasoning behind sending the above packets as multicasts is best explained by an example. Consider the network configuration depicted in Figure 15. Suppose RT4 has been elected as Designated Router, and RT3 as Backup Designated Router for the network N3. When Router RT4 floods a new LSA to Network N3, it is received by routers RT1, RT2, and RT3. These routers will not flood the LSA back onto net N3, but they still must ensure that their link-state databases remain synchronized with their adjacent neighbors. So RT1, RT2, and RT4 are waiting to see an acknowledgment from RT3. Likewise, RT4 and RT3 are both waiting to see acknowledgments from RT1 and RT2. This is best achieved by sending the acknowledgments as multicasts.

The reason that the acknowledgment logic for Backup DRs is slightly different is because they perform differently during the flooding of LSAs (see Section 13.3, step 4).

### 13.6. Retransmitting LSAs

LSAs flooded out an adjacency are placed on the adjacency's Link state retransmission list. In order to ensure that flooding is reliable, these LSAs are retransmitted until they are acknowledged. The length of time between retransmissions is a configurable per-interface value, RxmtInterval. If this is set

too low for an interface, needless retransmissions will ensue. If the value is set too high, the speed of the flooding, in the face of lost packets, may be affected.

Several retransmitted LSAs may fit into a single Link State Update packet. When LSAs are to be retransmitted, only the number fitting in a single Link State Update packet should be sent. Another packet of retransmissions can be sent whenever some of the LSAs are acknowledged, or on the next firing of the retransmission timer.

Link State Update Packets carrying retransmissions are always sent directly to the neighbor. On multi-access networks, this means that retransmissions are sent directly to the neighbor's IP address. Each LSA's LS age must be incremented by InfTransDelay (which must be > 0) when it is copied into the outgoing Link State Update packet (until the LS age field reaches the maximum value of MaxAge).

If an adjacent router goes down, retransmissions may occur until the adjacency is destroyed by OSPF's Hello Protocol. When the adjacency is destroyed, the Link state retransmission list is cleared.

#### 13.7. Receiving link state acknowledgments

Many consistency checks have been made on a received Link State Acknowledgment packet before it is handed to the flooding procedure. In particular, it has been associated with a particular neighbor. If this neighbor is in a lesser state than Exchange, the Link State Acknowledgment packet is discarded.

Otherwise, for each acknowledgment in the Link State Acknowledgment packet, the following steps are performed:

- o Does the LSA acknowledged have an instance on the Link state retransmission list for the neighbor? If not, examine the next acknowledgment. Otherwise:

- o If the acknowledgment is for the same instance that is contained on the list, remove the item from the list and examine the next acknowledgment. Otherwise:
- o Log the questionable acknowledgment, and examine the next one.

#### 14. Aging The Link State Database

Each LSA has an LS age field. The LS age is expressed in seconds. An LSA's LS age field is incremented while it is contained in a router's database. Also, when copied into a Link State Update Packet for flooding out a particular interface, the LSA's LS age is incremented by InfTransDelay.

An LSA's LS age is never incremented past the value MaxAge. LSAs having age MaxAge are not used in the routing table calculation. As a router ages its link state database, an LSA's LS age may reach MaxAge.[21] At this time, the router must attempt to flush the LSA from the routing domain. This is done simply by reflooding the MaxAge LSA just as if it was a newly originated LSA (see Section 13.3).

When creating a Database summary list for a newly forming adjacency, any MaxAge LSAs present in the link state database are added to the neighbor's Link state retransmission list instead of the neighbor's Database summary list. See Section 10.3 for more details.

A MaxAge LSA must be removed immediately from the router's link state database as soon as both a) it is no longer contained on any neighbor Link state retransmission lists and b) none of the router's neighbors are in states Exchange or Loading.

When, in the process of aging the link state database, an LSA's LS age hits a multiple of CheckAge, its LS checksum should be verified. If the LS checksum is incorrect, a program or memory error has been detected, and at the very least the router itself should be restarted.

#### 14.1. Premature aging of LSAs

An LSA can be flushed from the routing domain by setting its LS age to MaxAge, while leaving its LS sequence number alone, and then reflooding the LSA. This procedure follows the same course as flushing an LSA whose LS age has naturally reached the value MaxAge (see Section 14). In particular, the MaxAge LSA is removed from the router's link state database as soon as a) it is no longer contained on any neighbor Link state retransmission lists and b) none of the router's neighbors are in states Exchange or Loading. We call the setting of an LSA's LS age to MaxAge "premature aging".

Premature aging is used when it is time for a self-originated LSA's sequence number field to wrap. At this point, the current LSA instance (having LS sequence number MaxSequenceNumber) must be prematurely aged and flushed from the routing domain before a new instance with sequence number equal to InitialSequenceNumber can be originated. See Section 12.1.6 for more information.

Premature aging can also be used when, for example, one of the router's previously advertised external routes is no longer reachable. In this circumstance, the router can flush its AS-external-LSA from the routing domain via premature aging. This procedure is preferable to the alternative, which is to originate a new LSA for the destination specifying a metric of LSInfinity. Premature aging is also be used when unexpectedly receiving self-originated LSAs during the flooding procedure (see Section 13.4).

A router may only prematurely age its own self-originated LSAs. The router may not prematurely age LSAs that have been originated by other routers. An LSA is considered self-originated when either 1) the LSA's Advertising Router is equal to the router's own Router ID or 2) the LSA is a network-LSA and its Link State ID is equal to one of the router's own IP interface addresses.

## 15. Virtual Links

The single backbone area (Area ID = 0.0.0.0) cannot be disconnected, or some areas of the Autonomous System will become unreachable. To establish/maintain connectivity of the backbone, virtual links can be configured through non-backbone areas. Virtual links serve to connect physically separate components of the backbone. The two endpoints of a virtual link are area border routers. The virtual link must be configured in both routers. The configuration information in each router consists of the other virtual endpoint (the other area border router), and the non-backbone area the two routers have in common (called the Transit area). Virtual links cannot be configured through stub areas (see Section 3.6).

The virtual link is treated as if it were an unnumbered point-to-point network belonging to the backbone and joining the two area border routers. An attempt is made to establish an adjacency over the virtual link. When this adjacency is established, the virtual link will be included in backbone router-LSAs, and OSPF packets pertaining to the backbone area will flow over the adjacency. Such an adjacency has been referred to in this document as a "virtual adjacency".

In each endpoint router, the cost and viability of the virtual link is discovered by examining the routing table entry for the other endpoint router. (The entry's associated area must be the configured Transit area). This is called the virtual link's corresponding routing table entry. The InterfaceUp event occurs for a virtual link when its corresponding routing table entry becomes reachable. Conversely, the InterfaceDown event occurs when its routing table entry becomes unreachable. In other words, the virtual link's viability is determined by the existence of an intra-area path, through the Transit area, between the two endpoints. Note that a virtual link whose underlying path has cost greater than hexadecimal 0xffff (the maximum size of an interface cost in a router-LSA) should be considered inoperational (i.e., treated the same as if the path did not exist).

The other details concerning virtual links are as follows:

- o AS-external-LSAs are NEVER flooded over virtual adjacencies. This would be duplication of effort, since the same AS-

external-LSAs are already flooded throughout the virtual link's Transit area. For this same reason, AS-external-LSAs are not summarized over virtual adjacencies during the Database Exchange process.

- o The cost of a virtual link is NOT configured. It is defined to be the cost of the intra-area path between the two defining area border routers. This cost appears in the virtual link's corresponding routing table entry. When the cost of a virtual link changes, a new router-LSA should be originated for the backbone area.
- o Just as the virtual link's cost and viability are determined by the routing table build process (through construction of the routing table entry for the other endpoint), so are the IP interface address for the virtual interface and the virtual neighbor's IP address. These are used when sending OSPF protocol packets over the virtual link. Note that when one (or both) of the virtual link endpoints connect to the Transit area via an unnumbered point-to-point link, it may be impossible to calculate either the virtual interface's IP address and/or the virtual neighbor's IP address, thereby causing the virtual link to fail.
- o In each endpoint's router-LSA for the backbone, the virtual link is represented as a Type 4 link whose Link ID is set to the virtual neighbor's OSPF Router ID and whose Link Data is set to the virtual interface's IP address. See Section 12.4.1 for more information.
- o A non-backbone area can carry transit data traffic (i.e., is considered a "transit area") if and only if it serves as the Transit area for one or more fully adjacent virtual links (see TransitCapability in Sections 6 and 16.1). Such an area requires special treatment when summarizing backbone networks into it (see Section 12.4.3), and during the routing calculation (see Section 16.3).
- o The time between link state retransmissions, RxmtInterval, is configured for a virtual link. This should be well over the expected round-trip delay between the two routers. This may be

hard to estimate for a virtual link; it is better to err on the side of making it too large.

#### 16. Calculation of the routing table

This section details the OSPF routing table calculation. Using its attached areas' link state databases as input, a router runs the following algorithm, building its routing table step by step. At each step, the router must access individual pieces of the link state databases (e.g., a router-LSA originated by a certain router). This access is performed by the lookup function discussed in Section 12.2. The lookup process may return an LSA whose LS age is equal to MaxAge. Such an LSA should not be used in the routing table calculation, and is treated just as if the lookup process had failed.

The OSPF routing table's organization is explained in Section 11. Two examples of the routing table build process are presented in Sections 11.2 and 11.3. This process can be broken into the following steps:

- (1) The present routing table is invalidated. The routing table is built again from scratch. The old routing table is saved so that changes in routing table entries can be identified.
- (2) The intra-area routes are calculated by building the shortest-path tree for each attached area. In particular, all routing table entries whose Destination Type is "area border router" are calculated in this step. This step is described in two parts. At first the tree is constructed by only considering those links between routers and transit networks. Then the stub networks are incorporated into the tree. During the area's shortest-path tree calculation, the area's TransitCapability is also calculated for later use in Step 4.
- (3) The inter-area routes are calculated, through examination of summary-LSAs. If the router is attached to multiple areas (i.e., it is an area border router), only backbone summary-LSAs are examined.



- (4) In area border routers connecting to one or more transit areas (i.e, non-backbone areas whose TransitCapability is found to be TRUE), the transit areas' summary-LSAs are examined to see whether better paths exist using the transit areas than were found in Steps 2-3 above.
- (5) Routes to external destinations are calculated, through examination of AS-external-LSAs. The locations of the AS boundary routers (which originate the AS-external-LSAs) have been determined in steps 2-4.

Steps 2-5 are explained in further detail below.

Changes made to routing table entries as a result of these calculations can cause the OSPF protocol to take further actions. For example, a change to an intra-area route will cause an area border router to originate new summary-LSAs (see Section 12.4). See Section 16.7 for a complete list of the OSPF protocol actions resulting from routing table changes.

#### 16.1. Calculating the shortest-path tree for an area

This calculation yields the set of intra-area routes associated with an area (called hereafter Area A). A router calculates the shortest-path tree using itself as the root.[22] The formation of the shortest path tree is done here in two stages. In the first stage, only links between routers and transit networks are considered. Using the Dijkstra algorithm, a tree is formed from this subset of the link state database. In the second stage, leaves are added to the tree by considering the links to stub networks.

The procedure will be explained using the graph terminology that was introduced in Section 2. The area's link state database is represented as a directed graph. The graph's vertices are routers, transit networks and stub networks. The first stage of the procedure concerns only the transit vertices (routers and transit networks) and their connecting links. Throughout the shortest path calculation, the following data is also associated with each transit vertex:

**Vertex (node) ID**

A 32-bit number which together with the vertex type (router or network) uniquely identifies the vertex. For router vertices the Vertex ID is the router's OSPF Router ID. For network vertices, it is the IP address of the network's Designated Router.

**An LSA**

Each transit vertex has an associated LSA. For router vertices, this is a router-LSA. For transit networks, this is a network-LSA (which is actually originated by the network's Designated Router). In any case, the LSA's Link State ID is always equal to the above Vertex ID.

**List of next hops**

The list of next hops for the current set of shortest paths from the root to this vertex. There can be multiple shortest paths due to the equal-cost multipath capability. Each next hop indicates the outgoing router interface to use when forwarding traffic to the destination. On broadcast, Point-to-MultiPoint and NBMA networks, the next hop also includes the IP address of the next router (if any) in the path towards the destination.

**Distance from root**

The link state cost of the current set of shortest paths from the root to the vertex. The link state cost of a path is calculated as the sum of the costs of the path's constituent links (as advertised in router-LSAs and network-LSAs). One path is said to be "shorter" than another if it has a smaller link state cost.

The first stage of the procedure (i.e., the Dijkstra algorithm) can now be summarized as follows. At each iteration of the algorithm, there is a list of candidate vertices. Paths from the root to these vertices have been found, but not necessarily the shortest ones. However, the paths to the candidate vertex that is closest to the root are guaranteed to be shortest; this vertex is added to the shortest-path tree, removed from the candidate list, and its adjacent vertices are examined for possible addition to/modification of the candidate list. The

algorithm then iterates again. It terminates when the candidate list becomes empty.

The following steps describe the algorithm in detail. Remember that we are computing the shortest path tree for Area A. All references to link state database lookup below are from Area A's database.

- (1) Initialize the algorithm's data structures. Clear the list of candidate vertices. Initialize the shortest-path tree to only the root (which is the router doing the calculation). Set Area A's TransitCapability to FALSE.
- (2) Call the vertex just added to the tree vertex V. Examine the LSA associated with vertex V. This is a lookup in the Area A's link state database based on the Vertex ID. If this is a router-LSA, and bit V of the router-LSA (see Section A.4.2) is set, set Area A's TransitCapability to TRUE. In any case, each link described by the LSA gives the cost to an adjacent vertex. For each described link, (say it joins vertex V to vertex W):
  - (a) If this is a link to a stub network, examine the next link in V's LSA. Links to stub networks will be considered in the second stage of the shortest path calculation.
  - (b) Otherwise, W is a transit vertex (router or transit network). Look up the vertex W's LSA (router-LSA or network-LSA) in Area A's link state database. If the LSA does not exist, or its LS age is equal to MaxAge, or it does not have a link back to vertex V, examine the next link in V's LSA.[23]
  - (c) If vertex W is already on the shortest-path tree, examine the next link in the LSA.
  - (d) Calculate the link state cost D of the resulting path from the root to vertex W. D is equal to the sum of the link state cost of the (already calculated) shortest path to vertex V and the advertised cost of the link between vertices V and W. If D is:

- o Greater than the value that already appears for vertex W on the candidate list, then examine the next link.
  - o Equal to the value that appears for vertex W on the candidate list, calculate the set of next hops that result from using the advertised link. Input to this calculation is the destination (W), and its parent (V). This calculation is shown in Section 16.1.1. This set of hops should be added to the next hop values that appear for W on the candidate list.
  - o Less than the value that appears for vertex W on the candidate list, or if W does not yet appear on the candidate list, then set the entry for W on the candidate list to indicate a distance of D from the root. Also calculate the list of next hops that result from using the advertised link, setting the next hop values for W accordingly. The next hop calculation is described in Section 16.1.1; it takes as input the destination (W) and its parent (V).
- (3) If at this step the candidate list is empty, the shortest-path tree (of transit vertices) has been completely built and this stage of the procedure terminates. Otherwise, choose the vertex belonging to the candidate list that is closest to the root, and add it to the shortest-path tree (removing it from the candidate list in the process). Note that when there is a choice of vertices closest to the root, network vertices must be chosen before router vertices in order to necessarily find all equal-cost paths. This is consistent with the tie-breakers that were introduced in the modified Dijkstra algorithm used by OSPF's Multicast routing extensions (MOSPF).
- (4) Possibly modify the routing table. For those routing table entries modified, the associated area will be set to Area A, the path type will be set to intra-area, and the cost will be set to the newly discovered shortest path's calculated distance.

If the newly added vertex is an area border router or AS boundary router, a routing table entry is added whose destination type is "router". The Options field found in the associated router-LSA is copied into the routing table entry's Optional capabilities field. Call the newly added vertex Router X. If Router X is the endpoint of one of the calculating router's virtual links, and the virtual link uses Area A as Transit area: the virtual link is declared up, the IP address of the virtual interface is set to the IP address of the outgoing interface calculated above for Router X, and the virtual neighbor's IP address is set to Router X's interface address (contained in Router X's router-LSA) that points back to the root of the shortest-path tree; equivalently, this is the interface that points back to Router X's parent vertex on the shortest-path tree (similar to the calculation in Section 16.1.1).

If the newly added vertex is a transit network, the routing table entry for the network is located. The entry's Destination ID is the IP network number, which can be obtained by masking the Vertex ID (Link State ID) with its associated subnet mask (found in the body of the associated network-LSA). If the routing table entry already exists (i.e., there is already an intra-area route to the destination installed in the routing table), multiple vertices have mapped to the same IP network. For example, this can occur when a new Designated Router is being established. In this case, the current routing table entry should be overwritten if and only if the newly found path is just as short and the current routing table entry's Link State Origin has a smaller Link State ID than the newly added vertex' LSA.

If there is no routing table entry for the network (the usual case), a routing table entry for the IP network should be added. The routing table entry's Link State Origin should be set to the newly added vertex' LSA.

- (5) Iterate the algorithm by returning to Step 2.

The stub networks are added to the tree in the procedure's second stage. In this stage, all router vertices are again examined. Those that have been determined to be unreachable in the above first phase are discarded. For each reachable router vertex (call it *V*), the associated router-LSA is found in the link state database. Each stub network link appearing in the LSA is then examined, and the following steps are executed:

- (1) Calculate the distance *D* of stub network from the root. *D* is equal to the distance from the root to the router vertex (calculated in stage 1), plus the stub network link's advertised cost. Compare this distance to the current best cost to the stub network. This is done by looking up the stub network's current routing table entry. If the calculated distance *D* is larger, go on to examine the next stub network link in the LSA.
- (2) If this step is reached, the stub network's routing table entry must be updated. Calculate the set of next hops that would result from using the stub network link. This calculation is shown in Section 16.1.1; input to this calculation is the destination (the stub network) and the parent vertex (the router vertex). If the distance *D* is the same as the current routing table cost, simply add this set of next hops to the routing table entry's list of next hops. In this case, the routing table already has a Link State Origin. If this Link State Origin is a router-LSA whose Link State ID is smaller than *V*'s Router ID, reset the Link State Origin to *V*'s router-LSA.

Otherwise *D* is smaller than the routing table cost. Overwrite the current routing table entry by setting the routing table entry's cost to *D*, and by setting the entry's list of next hops to the newly calculated set. Set the routing table entry's Link State Origin to *V*'s router-LSA. Then go on to examine the next stub network link.

For all routing table entries added/modified in the second stage, the associated area will be set to Area A and the path type will be set to intra-area. When the list of reachable router-LSAs is exhausted, the second stage is completed. At

this time, all intra-area routes associated with Area A have been determined.

The specification does not require that the above two stage method be used to calculate the shortest path tree. However, if another algorithm is used, an identical tree must be produced. For this reason, it is important to note that links between transit vertices must be bidirectional in order to be included in the above tree. It should also be mentioned that more efficient algorithms exist for calculating the tree; for example, the incremental SPF algorithm described in [Ref1].

#### 16.1.1. The next hop calculation

This section explains how to calculate the current set of next hops to use for a destination. Each next hop consists of the outgoing interface to use in forwarding packets to the destination together with the IP address of the next hop router (if any). The next hop calculation is invoked each time a shorter path to the destination is discovered. This can happen in either stage of the shortest-path tree calculation (see Section 16.1). In stage 1 of the shortest-path tree calculation a shorter path is found as the destination is added to the candidate list, or when the destination's entry on the candidate list is modified (Step 2d of Stage 1). In stage 2 a shorter path is discovered each time the destination's routing table entry is modified (Step 2 of Stage 2).

The set of next hops to use for the destination may be recalculated several times during the shortest-path tree calculation, as shorter and shorter paths are discovered. In the end, the destination's routing table entry will always reflect the next hops resulting from the absolute shortest path(s).

Input to the next hop calculation is a) the destination and b) its parent in the current shortest path between the root (the calculating router) and the destination. The parent is always a transit vertex (i.e., always a router or a transit network).

If there is at least one intervening router in the current shortest path between the destination and the root, the destination simply inherits the set of next hops from the parent. Otherwise, there are two cases. In the first case, the parent vertex is the root (the calculating router itself). This means that the destination is either a directly connected network or directly connected router. The outgoing interface in this case is simply the OSPF interface connecting to the destination network/router. If the destination is a router which connects to the calculating router via a Point-to-MultiPoint network, the destination's next hop IP address(es) can be determined by examining the destination's router-LSA: each link pointing back to the calculating router and having a Link Data field belonging to the Point-to-MultiPoint network provides an IP address of the next hop router. If the destination is a directly connected network, or a router which connects to the calculating router via a point-to-point interface, no next hop IP address is required. If the destination is a router connected to the calculating router via a virtual link, the setting of the next hop should be deferred until the calculation in Section 16.3.

In the second case, the parent vertex is a network that directly connects the calculating router to the destination router. The list of next hops is then determined by examining the destination's router-LSA. For each link in the router-LSA that points back to the parent network, the link's Link Data field provides the IP address of a next hop router. The outgoing interface to use can then be derived from the next hop IP address (or it can be inherited from the parent network).

#### 16.2. Calculating the inter-area routes

The inter-area routes are calculated by examining summary-LSAs. If the router has active attachments to multiple areas, only backbone summary-LSAs are examined. Routers attached to a single area examine that area's summary-LSAs. In either case, the summary-LSAs examined below are all part of a single area's link state database (call it Area A).



Summary-LSAs are originated by the area border routers. Each summary-LSA in Area A is considered in turn. Remember that the destination described by a summary-LSA is either a network (Type 3 summary-LSAs) or an AS boundary router (Type 4 summary-LSAs). For each summary-LSA:

- (1) If the cost specified by the LSA is LSInfinity, or if the LSA's LS age is equal to MaxAge, then examine the the next LSA.
- (2) If the LSA was originated by the calculating router itself, examine the next LSA.
- (3) If it is a Type 3 summary-LSA, and the collection of destinations described by the summary-LSA equals one of the router's configured area address ranges (see Section 3.5), and the particular area address range is active, then the summary-LSA should be ignored. "Active" means that there are one or more reachable (by intra-area paths) networks contained in the area range.
- (4) Else, call the destination described by the LSA N (for Type 3 summary-LSAs, N's address is obtained by masking the LSA's Link State ID with the network/subnet mask contained in the body of the LSA), and the area border originating the LSA BR. Look up the routing table entry for BR having Area A as its associated area. If no such entry exists for router BR (i.e., BR is unreachable in Area A), do nothing with this LSA and consider the next in the list. Else, this LSA describes an inter-area path to destination N, whose cost is the distance to BR plus the cost specified in the LSA. Call the cost of this inter-area path IAC.
- (5) Next, look up the routing table entry for the destination N. (If N is an AS boundary router, look up the "router" routing table entry associated with Area A). If no entry exists for N or if the entry's path type is "type 1 external" or "type 2 external", then install the inter-area path to N, with associated area Area A, cost IAC, next hop equal to the list of next hops to router BR, and Advertising router equal to BR.

- (6) Else, if the paths present in the table are intra-area paths, do nothing with the LSA (intra-area paths are always preferred).
- (7) Else, the paths present in the routing table are also inter-area paths. Install the new path through BR if it is cheaper, overriding the paths in the routing table. Otherwise, if the new path is the same cost, add it to the list of paths that appear in the routing table entry.

### 16.3. Examining transit areas' summary-LSAs

This step is only performed by area border routers attached to one or more non-backbone areas that are capable of carrying transit traffic (i.e., "transit areas", or those areas whose `TransitCapability` parameter has been set to `TRUE` in Step 2 of the Dijkstra algorithm (see Section 16.1)).

The purpose of the calculation below is to examine the transit areas to see whether they provide any better (shorter) paths than the paths previously calculated in Sections 16.1 and 16.2. Any paths found that are better than or equal to previously discovered paths are installed in the routing table.

The calculation also determines the actual next hop(s) for those destinations whose next hop was calculated as a virtual link in Sections 16.1 and 16.2. After completion of the calculation below, any paths calculated in Sections 16.1 and 16.2 that still have unresolved virtual next hops should be discarded.

The calculation proceeds as follows. All the transit areas' summary-LSAs are examined in turn. Each such summary-LSA describes a route through a transit area Area A to a Network N (N's address is obtained by masking the LSA's Link State ID with the network/subnet mask contained in the body of the LSA) or in the case of a Type 4 summary-LSA, to an AS boundary router N. Suppose also that the summary-LSA was originated by an area border router BR.

- (1) If the cost advertised by the summary-LSA is `LSInfinity`, or if the LSA's LS age is equal to `MaxAge`, then examine the next LSA.

- (2) If the summary-LSA was originated by the calculating router itself, examine the next LSA.
- (3) Look up the routing table entry for N. (If N is an AS boundary router, look up the "router" routing table entry associated with the backbone area). If it does not exist, or if the route type is other than intra-area or inter-area, or if the area associated with the routing table entry is not the backbone area, then examine the next LSA. In other words, this calculation only updates backbone intra-area routes found in Section 16.1 and inter-area routes found in Section 16.2.
- (4) Look up the routing table entry for the advertising router BR associated with the Area A. If it is unreachable, examine the next LSA. Otherwise, the cost to destination N is the sum of the cost in BR's Area A routing table entry and the cost advertised in the LSA. Call this cost IAC.
- (5) If this cost is less than the cost occurring in N's routing table entry, overwrite N's list of next hops with those used for BR, and set N's routing table cost to IAC. Else, if IAC is the same as N's current cost, add BR's list of next hops to N's list of next hops. In any case, the area associated with N's routing table entry must remain the backbone area, and the path type (either intra-area or inter-area) must also remain the same.

It is important to note that the above calculation never makes unreachable destinations reachable, but instead just potentially finds better paths to already reachable destinations. The calculation installs any better cost found into the routing table entry, from which it may be readvertised in summary-LSAs to other areas.

As an example of the calculation, consider the Autonomous System pictured in Figure 17. There is a single non-backbone area (Area 1) that physically divides the backbone into two separate pieces. To maintain connectivity of the backbone, a virtual link has been configured between routers RT1 and RT4. On the right side of the figure, Network N1 belongs to the backbone. The dotted lines indicate that there is a much shorter intra-area



#### 16.4. Calculating AS external routes

AS external routes are calculated by examining AS-external-LSAs. Each of the AS-external-LSAs is considered in turn. Most AS-external-LSAs describe routes to specific IP destinations. An AS-external-LSA can also describe a default route for the Autonomous System (Destination ID = DefaultDestination, network/subnet mask = 0x00000000). For each AS-external-LSA:

- (1) If the cost specified by the LSA is LSInfinity, or if the LSA's LS age is equal to MaxAge, then examine the next LSA.
- (2) If the LSA was originated by the calculating router itself, examine the next LSA.
- (3) Call the destination described by the LSA N. N's address is obtained by masking the LSA's Link State ID with the network/subnet mask contained in the body of the LSA. Look up the routing table entries (potentially one per attached area) for the AS boundary router (ASBR) that originated the LSA. If no entries exist for router ASBR (i.e., ASBR is unreachable), do nothing with this LSA and consider the next in the list.

Else, this LSA describes an AS external path to destination N. Examine the forwarding address specified in the AS-external-LSA. This indicates the IP address to which packets for the destination should be forwarded.

If the forwarding address is set to 0.0.0.0, packets should be sent to the ASBR itself. Among the multiple routing table entries for the ASBR, select the preferred entry as follows. If RFC1583Compatibility is set to "disabled", prune the set of routing table entries for the ASBR as described in Section 16.4.1. In any case, among the remaining routing table entries, select the routing table entry with the least cost; when there are multiple least cost routing table entries the entry whose associated area has the largest OSPF Area ID (when considered as an unsigned 32-bit integer) is chosen.

If the forwarding address is non-zero, look up the forwarding address in the routing table.[24] The matching routing table entry must specify an intra-area or inter-area path; if no such path exists, do nothing with the LSA and consider the next in the list.

- (4) Let X be the cost specified by the preferred routing table entry for the ASBR/forwarding address, and Y the cost specified in the LSA. X is in terms of the link state metric, and Y is a type 1 or 2 external metric.
- (5) Look up the routing table entry for the destination N. If no entry exists for N, install the AS external path to N, with next hop equal to the list of next hops to the forwarding address, and advertising router equal to ASBR. If the external metric type is 1, then the path-type is set to type 1 external and the cost is equal to X+Y. If the external metric type is 2, the path-type is set to type 2 external, the link state component of the route's cost is X, and the type 2 cost is Y.
- (6) Compare the AS external path described by the LSA with the existing paths in N's routing table entry, as follows. If the new path is preferred, it replaces the present paths in N's routing table entry. If the new path is of equal preference, it is added to N's routing table entry's list of paths.
  - (a) Intra-area and inter-area paths are always preferred over AS external paths.
  - (b) Type 1 external paths are always preferred over type 2 external paths. When all paths are type 2 external paths, the paths with the smallest advertised type 2 metric are always preferred.
  - (c) If the new AS external path is still indistinguishable from the current paths in the N's routing table entry, and RFC1583Compatibility is set to "disabled", select the preferred paths based on the intra-AS paths to the ASBR/forwarding addresses, as specified in Section 16.4.1.

- (d) If the new AS external path is still indistinguishable from the current paths in the N's routing table entry, select the preferred path based on a least cost comparison. Type 1 external paths are compared by looking at the sum of the distance to the forwarding address and the advertised type 1 metric (X+Y). Type 2 external paths advertising equal type 2 metrics are compared by looking at the distance to the forwarding addresses.

#### 16.4.1. External path preferences

When multiple intra-AS paths are available to ASBRs/forwarding addresses, the following rules indicate which paths are preferred. These rules apply when the same ASBR is reachable through multiple areas, or when trying to decide which of several AS-external-LSAs should be preferred. In the former case the paths all terminate at the same ASBR, while in the latter the paths terminate at separate ASBRs/forwarding addresses. In either case, each path is represented by a separate routing table entry as defined in Section 11.

This section only applies when RFC1583Compatibility is set to "disabled".

The path preference rules, stated from highest to lowest preference, are as follows. Note that as a result of these rules, there may still be multiple paths of the highest preference. In this case, the path to use must be determined based on cost, as described in Section 16.4.

- o Intra-area paths using non-backbone areas are always the most preferred.
- o The other paths, intra-area backbone paths and inter-area paths, are of equal preference.

#### 16.5. Incremental updates -- summary-LSAs

When a new summary-LSA is received, it is not necessary to recalculate the entire routing table. Call the destination

described by the summary-LSA N (N's address is obtained by masking the LSA's Link State ID with the network/subnet mask contained in the body of the LSA), and let Area A be the area to which the LSA belongs. There are then two separate cases:

Case 1: Area A is the backbone and/or the router is not an area border router.

In this case, the following calculations must be performed. First, if there is presently an inter-area route to the destination N, N's routing table entry is invalidated, saving the entry's values for later comparisons. Then the calculation in Section 16.2 is run again for the single destination N. In this calculation, all of Area A's summary-LSAs that describe a route to N are examined. In addition, if the router is an area border router attached to one or more transit areas, the calculation in Section 16.3 must be run again for the single destination. If the results of these calculations have changed the cost/path to an AS boundary router (as would be the case for a Type 4 summary-LSA) or to any forwarding addresses, all AS-external-LSAs will have to be reexamined by rerunning the calculation in Section 16.4. Otherwise, if N is now newly unreachable, the calculation in Section 16.4 must be rerun for the single destination N, in case an alternate external route to N exists.

Case 2: Area A is a transit area and the router is an area border router.

In this case, the following calculations must be performed. First, if N's routing table entry presently contains one or more inter-area paths that utilize the transit area Area A, these paths should be removed. If this removes all paths from the routing table entry, the entry should be invalidated. The entry's old values should be saved for later comparisons. Next the calculation in Section 16.3 must be run again for the single destination N. If the results of this calculation have caused the cost to N to increase, the complete routing table calculation must be rerun starting with the Dijkstra algorithm specified in Section 16.1. Otherwise, if the cost/path to an AS boundary router (as would be the case for a Type 4 summary-LSA) or to any forwarding addresses has changed, all AS-external-LSAs will



have to be reexamined by rerunning the calculation in Section 16.4. Otherwise, if N is now newly unreachable, the calculation in Section 16.4 must be rerun for the single destination N, in case an alternate external route to N exists.

#### 16.6. Incremental updates -- AS-external-LSAs

When a new AS-external-LSA is received, it is not necessary to recalculate the entire routing table. Call the destination described by the AS-external-LSA N. N's address is obtained by masking the LSA's Link State ID with the network/subnet mask contained in the body of the LSA. If there is already an intra-area or inter-area route to the destination, no recalculation is necessary (internal routes take precedence).

Otherwise, the procedure in Section 16.4 will have to be performed, but only for those AS-external-LSAs whose destination is N. Before this procedure is performed, the present routing table entry for N should be invalidated.

#### 16.7. Events generated as a result of routing table changes

Changes to routing table entries sometimes cause the OSPF area border routers to take additional actions. These routers need to act on the following routing table changes:

- o The cost or path type of a routing table entry has changed. If the destination described by this entry is a Network or AS boundary router, and this is not simply a change of AS external routes, new summary-LSAs may have to be generated (potentially one for each attached area, including the backbone). See Section 12.4.3 for more information. If a previously advertised entry has been deleted, or is no longer advertisable to a particular area, the LSA must be flushed from the routing domain by setting its LS age to MaxAge and reflooding (see Section 14.1).
- o A routing table entry associated with a configured virtual link has changed. The destination of such a routing table entry is an area border router. The change indicates a modification to the virtual link's cost or viability.

If the entry indicates that the area border router is newly reachable, the corresponding virtual link is now operational. An InterfaceUp event should be generated for the virtual link, which will cause a virtual adjacency to begin to form (see Section 10.3). At this time the virtual link's IP interface address and the virtual neighbor's Neighbor IP address are also calculated.

If the entry indicates that the area border router is no longer reachable, the virtual link and its associated adjacency should be destroyed. This means an InterfaceDown event should be generated for the associated virtual link.

If the cost of the entry has changed, and there is a fully established virtual adjacency, a new router-LSA for the backbone must be originated. This in turn may cause further routing table changes.

#### 16.8. Equal-cost multipath

The OSPF protocol maintains multiple equal-cost routes to all destinations. This can be seen in the steps used above to calculate the routing table, and in the definition of the routing table structure.

Each one of the multiple routes will be of the same type (intra-area, inter-area, type 1 external or type 2 external), cost, and will have the same associated area. However, each route may specify a separate next hop and Advertising router.

There is no requirement that a router running OSPF keep track of all possible equal-cost routes to a destination. An implementation may choose to keep only a fixed number of routes to any given destination. This does not affect any of the algorithms presented in this specification.

## Footnotes

[1]The graph's vertices represent either routers, transit networks, or stub networks. Since routers may belong to multiple areas, it is not possible to color the graph's vertices.

[2]It is possible for all of a router's interfaces to be unnumbered point-to-point links. In this case, an IP address must be assigned to the router. This address will then be advertised in the router's router-LSA as a host route.

[3]Note that in these cases both interfaces, the non-virtual and the virtual, would have the same IP address.

[4]Note that no host route is generated for, and no IP packets can be addressed to, interfaces to unnumbered point-to-point networks. This is regardless of such an interface's state.

[5]It is instructive to see what happens when the Designated Router for the network crashes. Call the Designated Router for the network RT1, and the Backup Designated Router RT2. If Router RT1 crashes (or maybe its interface to the network dies), the other routers on the network will detect RT1's absence within RouterDeadInterval seconds. All routers may not detect this at precisely the same time; the routers that detect RT1's absence before RT2 does will, for a time, select RT2 to be both Designated Router and Backup Designated Router. When RT2 detects that RT1 is gone it will move itself to Designated Router. At this time, the remaining router having highest Router Priority will be selected as Backup Designated Router.

[6]On point-to-point networks, the lower level protocols indicate whether the neighbor is up and running. Likewise, existence of the neighbor on virtual links is indicated by the routing table calculation. However, in both these cases, the Hello Protocol is still used. This ensures that communication between the neighbors is bidirectional, and that each of the neighbors has a functioning routing protocol layer.

[7]When the identity of the Designated Router is changing, it may be quite common for a neighbor in this state to send the router a

Database Description packet; this means that there is some momentary disagreement on the Designated Router's identity.

[8]Note that it is possible for a router to resynchronize any of its fully established adjacencies by setting the adjacency's state back to ExStart. This will cause the other end of the adjacency to process a SeqNumberMismatch event, and therefore to also go back to ExStart state.

[9]The address space of IP networks and the address space of OSPF Router IDs may overlap. That is, a network may have an IP address which is identical (when considered as a 32-bit number) to some router's Router ID.

[10]"Discard" entries are necessary to ensure that route summarization at area boundaries will not cause packet looping.

[11]It is assumed that, for two different address ranges matching the destination, one range is more specific than the other. Non-contiguous subnet masks can be configured to violate this assumption. Such subnet mask configurations cannot be handled by the OSPF protocol.

[12]MaxAgeDiff is an architectural constant. It indicates the maximum dispersion of ages, in seconds, that can occur for a single LSA instance as it is flooded throughout the routing domain. If two LSAs differ by more than this, they are assumed to be different instances of the same LSA. This can occur when a router restarts and loses track of the LSA's previous LS sequence number. See Section 13.4 for more details.

[13]When two LSAs have different LS checksums, they are assumed to be separate instances. This can occur when a router restarts, and loses track of the LSA's previous LS sequence number. In the case where the two LSAs have the same LS sequence number, it is not possible to determine which LSA is actually newer. However, if the wrong LSA is accepted as newer, the originating router will simply originate another instance. See Section 13.4 for further details.

[14]There is one instance where a lookup must be done based on partial information. This is during the routing table calculation, when a network-LSA must be found based solely on its Link State ID.

The lookup in this case is still well defined, since no two network-LSAs can have the same Link State ID.

[15]This is the way RFC 1583 specified point-to-point representation. It has three advantages: a) it does not require allocating a subnet to the point-to-point link, b) it tends to bias the routing so that packets destined for the point-to-point interface will actually be received over the interface (which is useful for diagnostic purposes) and c) it allows network bootstrapping of a neighbor, without requiring that the bootstrap program contain an OSPF implementation.

[16]This is the more traditional point-to-point representation used by protocols such as RIP.

[17]This clause covers the case: Inter-area routes are not summarized to the backbone. This is because inter-area routes are always associated with the backbone area.

[18]This clause is only invoked when a non-backbone Area A supports transit data traffic (i.e., has TransitCapability set to TRUE). For example, in the area configuration of Figure 6, Area 2 can support transit traffic due to the configured virtual link between Routers RT10 and RT11. As a result, Router RT11 need only originate a single summary-LSA into Area 2 (having the collapsed destination N9-N11,H1), since all of Router RT11's other eligible routes have next hops belonging to Area 2 itself (and as such only need be advertised by other area border routers; in this case, Routers RT10 and RT7).

[19]By keeping more information in the routing table, it is possible for an implementation to recalculate the shortest path tree for only a single area. In fact, there are incremental algorithms that allow an implementation to recalculate only a portion of a single area's shortest path tree [Ref1]. However, these algorithms are beyond the scope of this specification.

[20]This is how the Link state request list is emptied, which eventually causes the neighbor state to transition to Full. See Section 10.9 for more details.

[21]It should be a relatively rare occurrence for an LSA's LS age to reach MaxAge in this fashion. Usually, the LSA will be replaced by

a more recent instance before it ages out.

[22]Strictly speaking, because of equal-cost multipath, the algorithm does not create a tree. We continue to use the "tree" terminology because that is what occurs most often in the existing literature.

[23]Note that the presence of any link back to V is sufficient; it need not be the matching half of the link under consideration from V to W. This is enough to ensure that, before data traffic flows between a pair of neighboring routers, their link state databases will be synchronized.

[24]When the forwarding address is non-zero, it should point to a router belonging to another Autonomous System. See Section 12.4.4 for more details.

## References

- [Ref1] McQuillan, J., I. Richer and E. Rosen, "ARPANET Routing Algorithm Improvements", BBN Technical Report 3803, April 1978.
- [Ref2] Digital Equipment Corporation, "Information processing systems -- Data communications -- Intermediate System to Intermediate System Intra-Domain Routing Protocol", October 1987.
- [Ref3] McQuillan, J., et.al., "The New Routing Algorithm for the ARPANET", IEEE Transactions on Communications, May 1980.
- [Ref4] Perlman, R., "Fault-Tolerant Broadcast of Routing Information", Computer Networks, December 1983.
- [Ref5] Postel, J., "Internet Protocol", STD 5, RFC 791, September 1981.
- [Ref6] McKenzie, A., "ISO Transport Protocol specification ISO DP 8073", RFC 905, April 1984.
- [Ref7] Deering, S., "Host extensions for IP multicasting", STD 5, RFC 1112, May 1988.
- [Ref8] McCloghrie, K., and M. Rose, "Management Information Base for network management of TCP/IP-based internets: MIB-II", STD 17, RFC 1213, March 1991.
- [Ref9] Moy, J., "OSPF Version 2", RFC 1583, March 1994.
- [Ref10] Fuller, V., T. Li, J. Yu, and K. Varadhan, "Classless Inter-Domain Routing (CIDR): an Address Assignment and Aggregation Strategy", RFC1519, September 1993.
- [Ref11] Reynolds, J., and J. Postel, "Assigned Numbers", STD 2, RFC 1700, October 1994.
- [Ref12] Almquist, P., "Type of Service in the Internet Protocol Suite", RFC 1349, July 1992.

- [Ref13] Leiner, B., et.al., "The DARPA Internet Protocol Suite", DDN Protocol Handbook, April 1985.
- [Ref14] Bradley, T., and C. Brown, "Inverse Address Resolution Protocol", RFC 1293, January 1992.
- [Ref15] deSouza, O., and M. Rodrigues, "Guidelines for Running OSPF Over Frame Relay Networks", RFC 1586, March 1994.
- [Ref16] Bellovin, S., "Security Problems in the TCP/IP Protocol Suite", ACM Computer Communications Review, Volume 19, Number 2, pp. 32-38, April 1989.
- [Ref17] Rivest, R., "The MD5 Message-Digest Algorithm", RFC 1321, April 1992.
- [Ref18] Moy, J., "Multicast Extensions to OSPF", RFC 1584, March 1994.
- [Ref19] Coltun, R., and V. Fuller, "The OSPF NSSA Option", RFC 1587, March 1994.
- [Ref20] Ferguson, D., "The OSPF External Attributes LSA", work in progress.
- [Ref21] Moy, J., "Extending OSPF to Support Demand Circuits", RFC 1793, April 1995.
- [Ref22] Mogul, J., and S. Deering, "Path MTU Discovery", RFC 1191, November 1990.
- [Ref23] Rekhter, Y., and T. Li, "A Border Gateway Protocol 4 (BGP-4)", RFC 1771, March 1995.
- [Ref24] Hinden, R., "Internet Routing Protocol Standardization Criteria", BBN, October 1991.
- [Ref25] Moy, J., "OSPF Version 2", RFC 2178, July 1997.
- [Ref26] Rosen, E., "Vulnerabilities of Network Control Protocols: An Example", Computer Communication Review, July 1981.



## A. OSPF data formats

This appendix describes the format of OSPF protocol packets and OSPF LSAs. The OSPF protocol runs directly over the IP network layer. Before any data formats are described, the details of the OSPF encapsulation are explained.

Next the OSPF Options field is described. This field describes various capabilities that may or may not be supported by pieces of the OSPF routing domain. The OSPF Options field is contained in OSPF Hello packets, Database Description packets and in OSPF LSAs.

OSPF packet formats are detailed in Section A.3. A description of OSPF LSAs appears in Section A.4.

### A.1 Encapsulation of OSPF packets

OSPF runs directly over the Internet Protocol's network layer. OSPF packets are therefore encapsulated solely by IP and local data-link headers.

OSPF does not define a way to fragment its protocol packets, and depends on IP fragmentation when transmitting packets larger than the network MTU. If necessary, the length of OSPF packets can be up to 65,535 bytes (including the IP header). The OSPF packet types that are likely to be large (Database Description Packets, Link State Request, Link State Update, and Link State Acknowledgment packets) can usually be split into several separate protocol packets, without loss of functionality. This is recommended; IP fragmentation should be avoided whenever possible. Using this reasoning, an attempt should be made to limit the sizes of OSPF packets sent over virtual links to 576 bytes unless Path MTU Discovery is being performed (see [Ref22]).

The other important features of OSPF's IP encapsulation are:

- o Use of IP multicast. Some OSPF messages are multicast, when sent over broadcast networks. Two distinct IP multicast addresses are used. Packets sent to these multicast addresses should never be forwarded; they are meant to travel a single hop only. To ensure that these packets will not travel multiple hops, their IP TTL must be set to 1.

**AllSPFRouters**

This multicast address has been assigned the value 224.0.0.5. All routers running OSPF should be prepared to receive packets sent to this address. Hello packets are always sent to this destination. Also, certain OSPF protocol packets are sent to this address during the flooding procedure.

**AllDRouters**

This multicast address has been assigned the value 224.0.0.6. Both the Designated Router and Backup Designated Router must be prepared to receive packets destined to this address. Certain OSPF protocol packets are sent to this address during the flooding procedure.

- o OSPF is IP protocol number 89. This number has been registered with the Network Information Center. IP protocol number assignments are documented in [Ref11].
- o All OSPF routing protocol packets are sent using the normal service TOS value of binary 0000 defined in [Ref12].
- o Routing protocol packets are sent with IP precedence set to Internetwork Control. OSPF protocol packets should be given precedence over regular IP data traffic, in both sending and receiving. Setting the IP precedence field in the IP header to Internetwork Control [Ref5] may help implement this objective.

## A.2 The Options field

The OSPF Options field is present in OSPF Hello packets, Database Description packets and all LSAs. The Options field enables OSPF routers to support (or not support) optional capabilities, and to communicate their capability level to other OSPF routers. Through this mechanism routers of differing capabilities can be mixed within an OSPF routing domain.

When used in Hello packets, the Options field allows a router to reject a neighbor because of a capability mismatch. Alternatively, when capabilities are exchanged in Database Description packets a router can choose not to forward certain LSAs to a neighbor because of its reduced functionality. Lastly, listing capabilities in LSAs allows routers to forward traffic around reduced functionality routers, by excluding them from parts of the routing table calculation.

Five bits of the OSPF Options field have been assigned, although only one (the E-bit) is described completely by this memo. Each bit is described briefly below. Routers should reset (i.e. clear) unrecognized bits in the Options field when sending Hello packets or Database Description packets and when originating LSAs. Conversely, routers encountering unrecognized Option bits in received Hello Packets, Database Description packets or LSAs should ignore the capability and process the packet/LSA normally.

```

+-----+
| * | * | DC | EA | N/P | MC | E | * |
+-----+

```

### The Options field

#### E-bit

This bit describes the way AS-external-LSAs are flooded, as described in Sections 3.6, 9.5, 10.8 and 12.1.2 of this memo.

#### MC-bit

This bit describes whether IP multicast datagrams are forwarded according to the specifications in [Ref18].

## N/P-bit

This bit describes the handling of Type-7 LSAs, as specified in [Ref19].

## EA-bit

This bit describes the router's willingness to receive and forward External-Attributes-LSAs, as specified in [Ref20].

## DC-bit

This bit describes the router's handling of demand circuits, as specified in [Ref21].

### A.3 OSPF Packet Formats

There are five distinct OSPF packet types. All OSPF packet types begin with a standard 24 byte header. This header is described first. Each packet type is then described in a succeeding section. In these sections each packet's division into fields is displayed, and then the field definitions are enumerated.

All OSPF packet types (other than the OSPF Hello packets) deal with lists of LSAs. For example, Link State Update packets implement the flooding of LSAs throughout the OSPF routing domain. Because of this, OSPF protocol packets cannot be parsed unless the format of LSAs is also understood. The format of LSAs is described in Section A.4.

The receive processing of OSPF packets is detailed in Section 8.2. The sending of OSPF packets is explained in Section 8.1.

A.3.1 The OSPF packet header

Every OSPF packet starts with a standard 24 byte header. This header contains all the information necessary to determine whether the packet should be accepted for further processing. This determination is described in Section 8.2 of the specification.

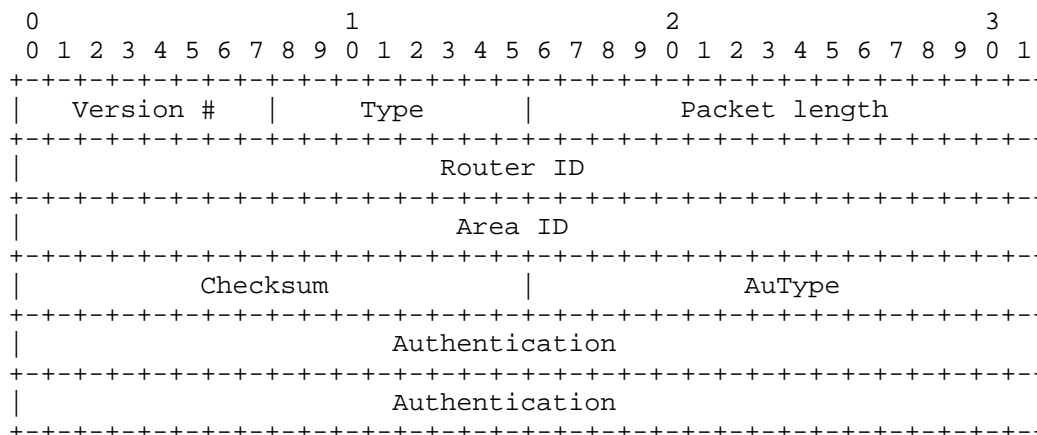

Version #

The OSPF version number. This specification documents version 2 of the protocol.

Type

The OSPF packet types are as follows. See Sections A.3.2 through A.3.6 for details.

Type	Description
1	Hello
2	Database Description
3	Link State Request
4	Link State Update
5	Link State Acknowledgment

#### Packet length

The length of the OSPF protocol packet in bytes. This length includes the standard OSPF header.

#### Router ID

The Router ID of the packet's source.

#### Area ID

A 32 bit number identifying the area that this packet belongs to. All OSPF packets are associated with a single area. Most travel a single hop only. Packets travelling over a virtual link are labelled with the backbone Area ID of 0.0.0.0.

#### Checksum

The standard IP checksum of the entire contents of the packet, starting with the OSPF packet header but excluding the 64-bit authentication field. This checksum is calculated as the 16-bit one's complement of the one's complement sum of all the 16-bit words in the packet, excepting the authentication field. If the packet's length is not an integral number of 16-bit words, the packet is padded with a byte of zero before checksumming. The checksum is considered to be part of the packet authentication procedure; for some authentication types the checksum calculation is omitted.

#### AuType

Identifies the authentication procedure to be used for the packet. Authentication is discussed in Appendix D of the specification. Consult Appendix D for a list of the currently defined authentication types.

**Authentication**

A 64-bit field for use by the authentication scheme. See Appendix D for details.



A.3.2 The Hello packet

Hello packets are OSPF packet type 1. These packets are sent periodically on all interfaces (including virtual links) in order to establish and maintain neighbor relationships. In addition, Hello Packets are multicast on those physical networks having a multicast or broadcast capability, enabling dynamic discovery of neighboring routers.

All routers connected to a common network must agree on certain parameters (Network mask, HelloInterval and RouterDeadInterval). These parameters are included in Hello packets, so that differences can inhibit the forming of neighbor relationships. A detailed explanation of the receive processing for Hello packets is presented in Section 10.5. The sending of Hello packets is covered in Section 9.5.

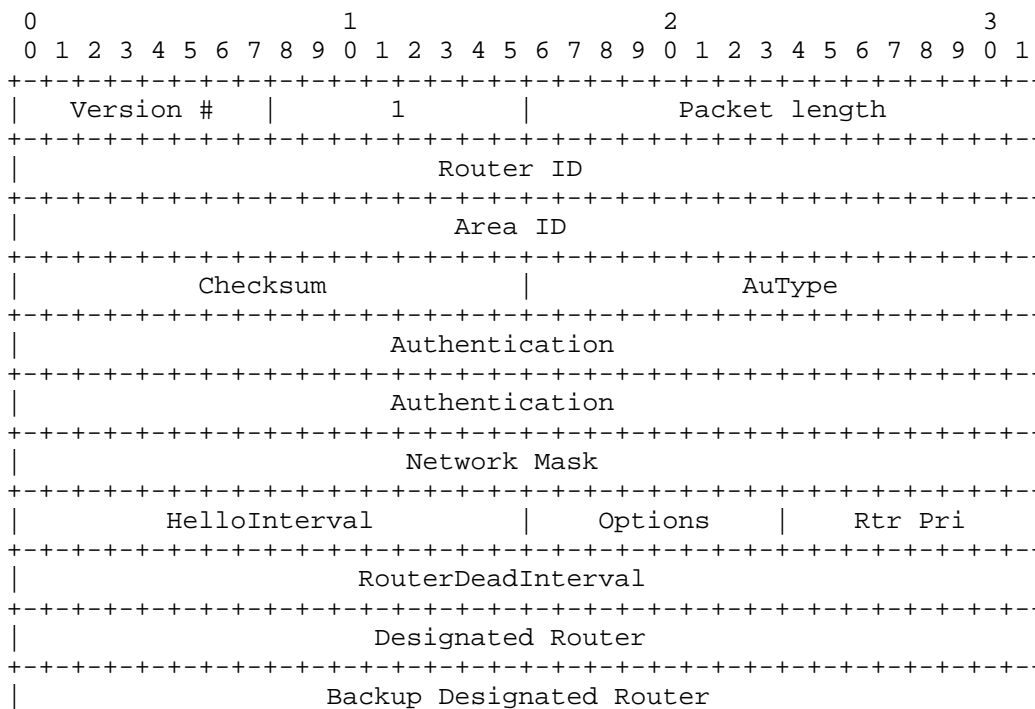

```

+-----+
|                                     |
|                                     | Neighbor |
|                                     |
+-----+
|                                     |
|                                     | ... |
|                                     |
+-----+

```

**Network mask**

The network mask associated with this interface. For example, if the interface is to a class B network whose third byte is used for subnetting, the network mask is 0xfffff00.

**Options**

The optional capabilities supported by the router, as documented in Section A.2.

**HelloInterval**

The number of seconds between this router's Hello packets.

**Rtr Pri**

This router's Router Priority. Used in (Backup) Designated Router election. If set to 0, the router will be ineligible to become (Backup) Designated Router.

**RouterDeadInterval**

The number of seconds before declaring a silent router down.

**Designated Router**

The identity of the Designated Router for this network, in the view of the sending router. The Designated Router is identified here by its IP interface address on the network. Set to 0.0.0.0 if there is no Designated Router.

**Backup Designated Router**

The identity of the Backup Designated Router for this network, in the view of the sending router. The Backup Designated Router is identified here by its IP interface address on the network. Set to 0.0.0.0 if there is no Backup Designated Router.

**Neighbor**

The Router IDs of each router from whom valid Hello packets have been seen recently on the network. Recently means in the last RouterDeadInterval seconds.

A.3.3 The Database Description packet

Database Description packets are OSPF packet type 2. These packets are exchanged when an adjacency is being initialized. They describe the contents of the link-state database. Multiple packets may be used to describe the database. For this purpose a poll-response procedure is used. One of the routers is designated to be the master, the other the slave. The master sends Database Description packets (polls) which are acknowledged by Database Description packets sent by the slave (responses). The responses are linked to the polls via the packets' DD sequence numbers.

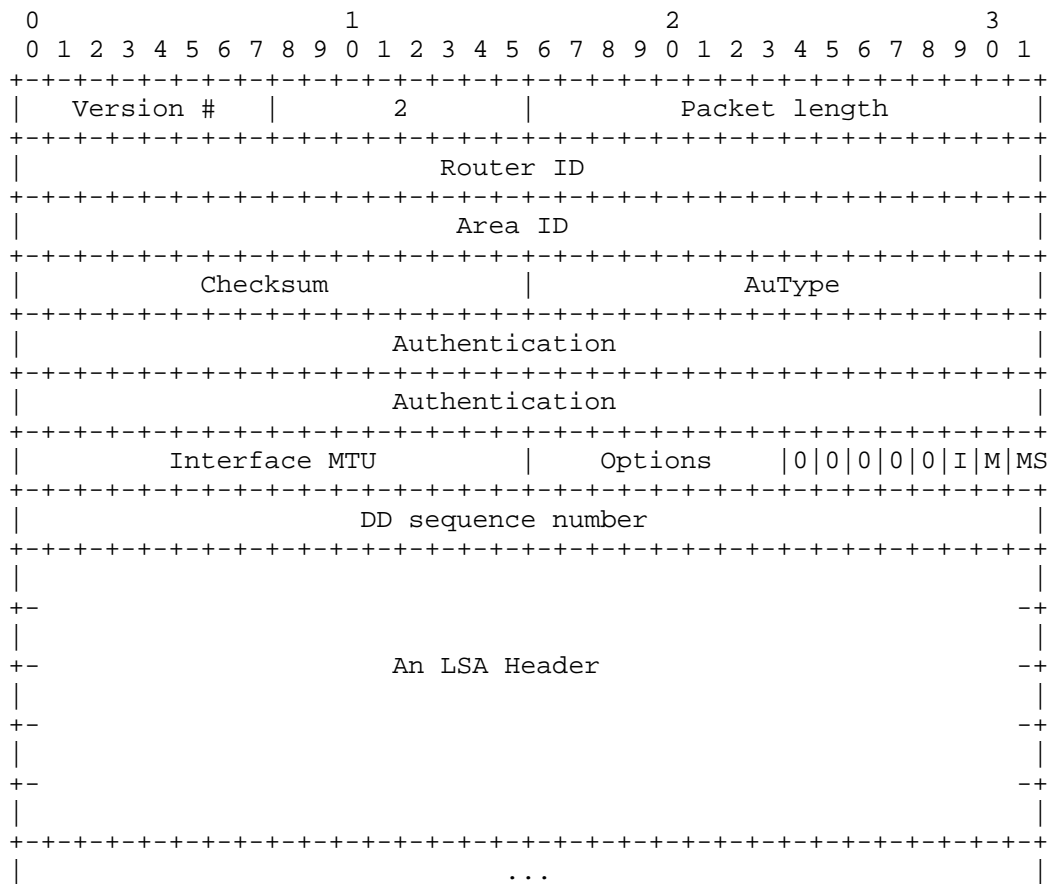

The format of the Database Description packet is very similar to both the Link State Request and Link State Acknowledgment packets. The main part of all three is a list of items, each item describing a piece of the link-state database. The sending of Database Description Packets is documented in Section 10.8. The reception of Database Description packets is documented in Section 10.6.

#### Interface MTU

The size in bytes of the largest IP datagram that can be sent out the associated interface, without fragmentation. The MTUs of common Internet link types can be found in Table 7-1 of [Ref22]. Interface MTU should be set to 0 in Database Description packets sent over virtual links.

#### Options

The optional capabilities supported by the router, as documented in Section A.2.

#### I-bit

The Init bit. When set to 1, this packet is the first in the sequence of Database Description Packets.

#### M-bit

The More bit. When set to 1, it indicates that more Database Description Packets are to follow.

#### MS-bit

The Master/Slave bit. When set to 1, it indicates that the router is the master during the Database Exchange process. Otherwise, the router is the slave.

#### DD sequence number

Used to sequence the collection of Database Description Packets. The initial value (indicated by the Init bit being set) should be unique. The DD sequence number then increments until the complete database description has been sent.

The rest of the packet consists of a (possibly partial) list of the link-state database's pieces. Each LSA in the database is described by its LSA header. The LSA header is documented in Section A.4.1. It contains all the information required to uniquely identify both the LSA and the LSA's current instance.

A.3.4 The Link State Request packet

Link State Request packets are OSPF packet type 3. After exchanging Database Description packets with a neighboring router, a router may find that parts of its link-state database are out-of-date. The Link State Request packet is used to request the pieces of the neighbor's database that are more up-to-date. Multiple Link State Request packets may need to be used.

A router that sends a Link State Request packet has in mind the precise instance of the database pieces it is requesting. Each instance is defined by its LS sequence number, LS checksum, and LS age, although these fields are not specified in the Link State Request Packet itself. The router may receive even more recent instances in response.

The sending of Link State Request packets is documented in Section 10.9. The reception of Link State Request packets is documented in Section 10.7.

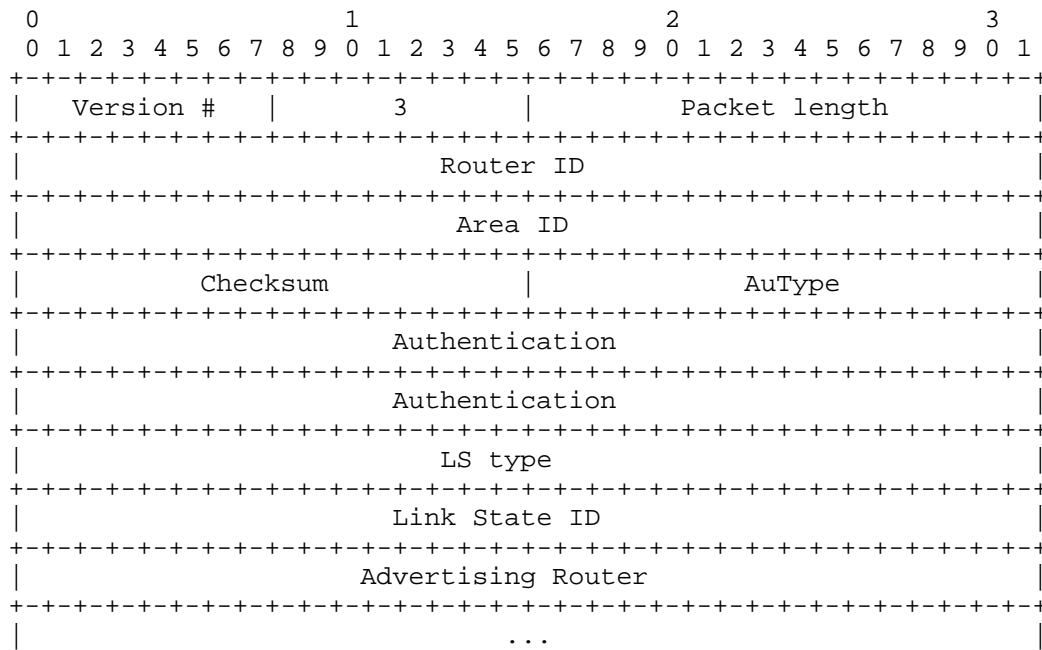

Each LSA requested is specified by its LS type, Link State ID, and Advertising Router. This uniquely identifies the LSA, but not its instance. Link State Request packets are understood to be requests for the most recent instance (whatever that might be).

A.3.5 The Link State Update packet

Link State Update packets are OSPF packet type 4. These packets implement the flooding of LSAs. Each Link State Update packet carries a collection of LSAs one hop further from their origin. Several LSAs may be included in a single packet.

Link State Update packets are multicast on those physical networks that support multicast/broadcast. In order to make the flooding procedure reliable, flooded LSAs are acknowledged in Link State Acknowledgment packets. If retransmission of certain LSAs is necessary, the retransmitted LSAs are always sent directly to the neighbor. For more information on the reliable flooding of LSAs, consult Section 13.

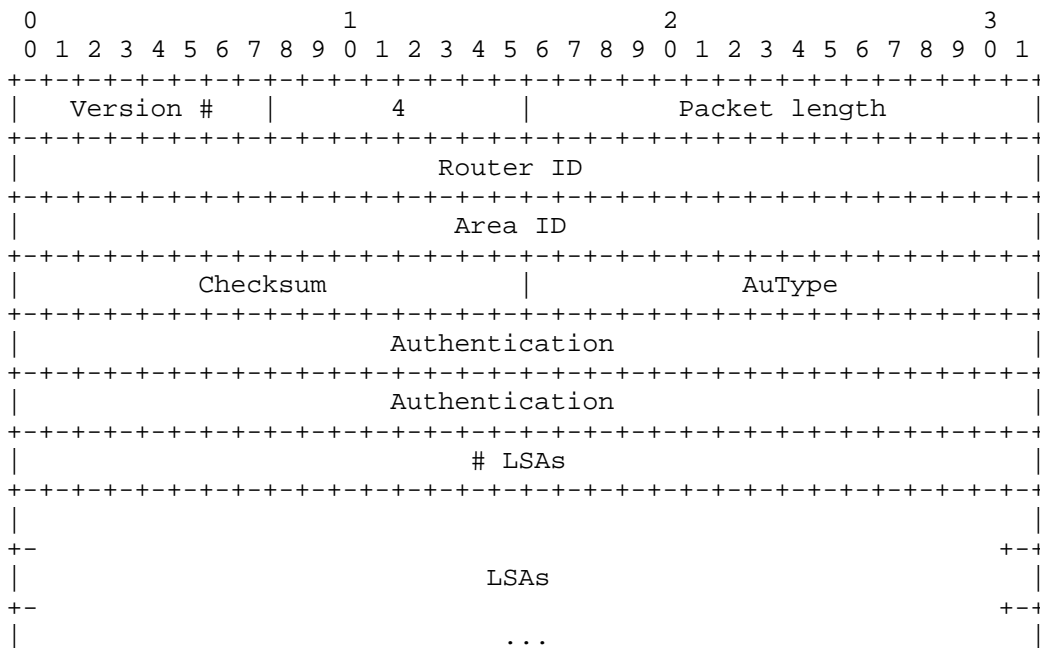

## # LSAs

The number of LSAs included in this update.

The body of the Link State Update packet consists of a list of LSAs. Each LSA begins with a common 20 byte header, described in Section A.4.1. Detailed formats of the different types of LSAs are described in Section A.4.



A.3.6 The Link State Acknowledgment packet

Link State Acknowledgment Packets are OSPF packet type 5. To make the flooding of LSAs reliable, flooded LSAs are explicitly acknowledged. This acknowledgment is accomplished through the sending and receiving of Link State Acknowledgment packets. Multiple LSAs can be acknowledged in a single Link State Acknowledgment packet.

Depending on the state of the sending interface and the sender of the corresponding Link State Update packet, a Link State Acknowledgment packet is sent either to the multicast address AllSPFRouters, to the multicast address AllDRouters, or as a unicast. The sending of Link State Acknowledgement packets is documented in Section 13.5. The reception of Link State Acknowledgement packets is documented in Section 13.7.

The format of this packet is similar to that of the Data Description packet. The body of both packets is simply a list of LSA headers.

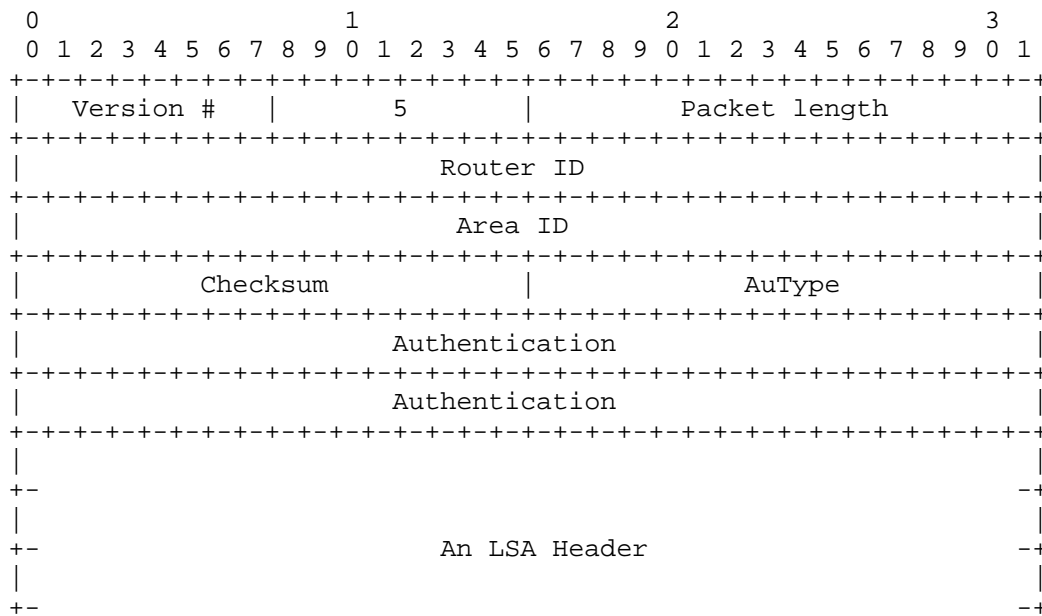

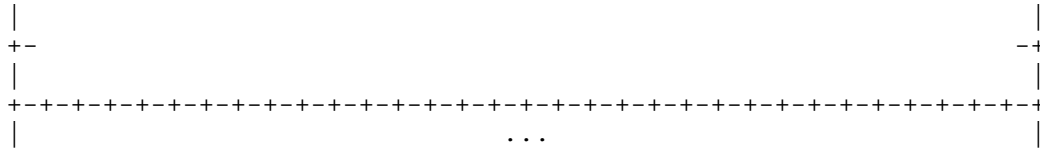

Each acknowledged LSA is described by its LSA header. The LSA header is documented in Section A.4.1. It contains all the information required to uniquely identify both the LSA and the LSA's current instance.

#### A.4 LSA formats

This memo defines five distinct types of LSAs. Each LSA begins with a standard 20 byte LSA header. This header is explained in Section A.4.1. Succeeding sections then diagram the separate LSA types.

Each LSA describes a piece of the OSPF routing domain. Every router originates a router-LSA. In addition, whenever the router is elected Designated Router, it originates a network-LSA. Other types of LSAs may also be originated (see Section 12.4). All LSAs are then flooded throughout the OSPF routing domain. The flooding algorithm is reliable, ensuring that all routers have the same collection of LSAs. (See Section 13 for more information concerning the flooding algorithm). This collection of LSAs is called the link-state database.

From the link state database, each router constructs a shortest path tree with itself as root. This yields a routing table (see Section 11). For the details of the routing table build process, see Section 16.

A.4.1 The LSA header

All LSAs begin with a common 20 byte header. This header contains enough information to uniquely identify the LSA (LS type, Link State ID, and Advertising Router). Multiple instances of the LSA may exist in the routing domain at the same time. It is then necessary to determine which instance is more recent. This is accomplished by examining the LS age, LS sequence number and LS checksum fields that are also contained in the LSA header.

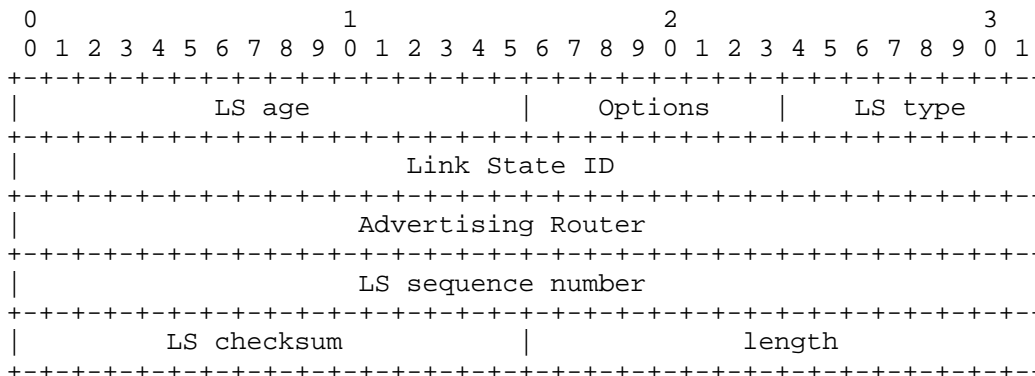

LS age

The time in seconds since the LSA was originated.

Options

The optional capabilities supported by the described portion of the routing domain. OSPF's optional capabilities are documented in Section A.2.

LS type

The type of the LSA. Each LSA type has a separate advertisement format. The LSA types defined in this memo are as follows (see Section 12.1.3 for further explanation):

LS Type	Description
1	Router-LSAs
2	Network-LSAs
3	Summary-LSAs (IP network)
4	Summary-LSAs (ASBR)
5	AS-external-LSAs

#### Link State ID

This field identifies the portion of the internet environment that is being described by the LSA. The contents of this field depend on the LSA's LS type. For example, in network-LSAs the Link State ID is set to the IP interface address of the network's Designated Router (from which the network's IP address can be derived). The Link State ID is further discussed in Section 12.1.4.

#### Advertising Router

The Router ID of the router that originated the LSA. For example, in network-LSAs this field is equal to the Router ID of the network's Designated Router.

#### LS sequence number

Detects old or duplicate LSAs. Successive instances of an LSA are given successive LS sequence numbers. See Section 12.1.6 for more details.

#### LS checksum

The Fletcher checksum of the complete contents of the LSA, including the LSA header but excluding the LS age field. See Section 12.1.7 for more details.

#### length

The length in bytes of the LSA. This includes the 20 byte LSA header.

A.4.2 Router-LSAs

Router-LSAs are the Type 1 LSAs. Each router in an area originates a router-LSA. The LSA describes the state and cost of the router's links (i.e., interfaces) to the area. All of the router's links to the area must be described in a single router-LSA. For details concerning the construction of router-LSAs, see Section 12.4.1.

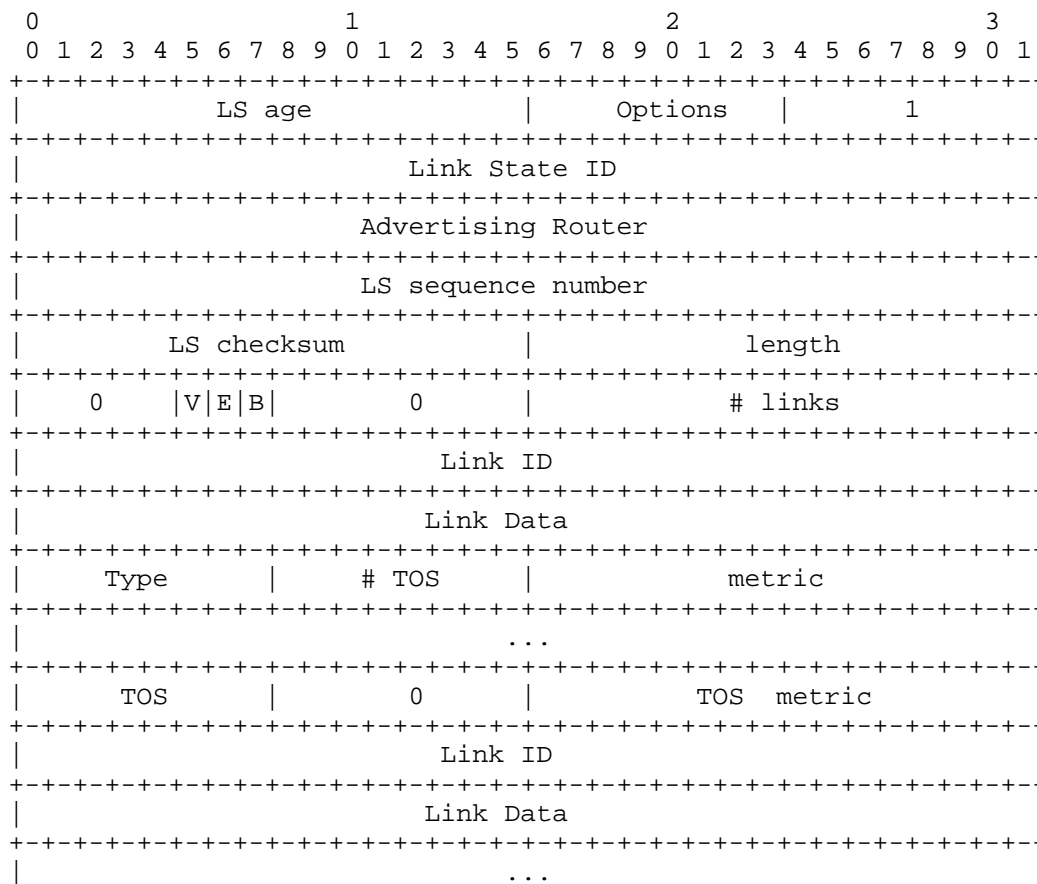

In router-LSAs, the Link State ID field is set to the router's OSPF Router ID. Router-LSAs are flooded throughout a single area only.

bit V

When set, the router is an endpoint of one or more fully adjacent virtual links having the described area as Transit area (V is for virtual link endpoint).

bit E

When set, the router is an AS boundary router (E is for external).

bit B

When set, the router is an area border router (B is for border).

# links

The number of router links described in this LSA. This must be the total collection of router links (i.e., interfaces) to the area.

The following fields are used to describe each router link (i.e., interface). Each router link is typed (see the below Type field). The Type field indicates the kind of link being described. It may be a link to a transit network, to another router or to a stub network. The values of all the other fields describing a router link depend on the link's Type. For example, each link has an associated 32-bit Link Data field. For links to stub networks this field specifies the network's IP address mask. For other link types the Link Data field specifies the router interface's IP address.

Type

A quick description of the router link. One of the following. Note that host routes are classified as links to stub networks with network mask of 0xffffffff.

Type	Description
1	Point-to-point connection to another router
2	Connection to a transit network
3	Connection to a stub network
4	Virtual link

#### Link ID

Identifies the object that this router link connects to. Value depends on the link's Type. When connecting to an object that also originates an LSA (i.e., another router or a transit network) the Link ID is equal to the neighboring LSA's Link State ID. This provides the key for looking up the neighboring LSA in the link state database during the routing table calculation. See Section 12.2 for more details.

Type	Link ID
1	Neighboring router's Router ID
2	IP address of Designated Router
3	IP network/subnet number
4	Neighboring router's Router ID

#### Link Data

Value again depends on the link's Type field. For connections to stub networks, Link Data specifies the network's IP address mask. For unnumbered point-to-point connections, it specifies the interface's MIB-II [Ref8] ifIndex value. For the other link types it specifies the router interface's IP address. This latter piece of information is needed during the routing table build process, when calculating the IP address of the next hop. See Section 16.1.1 for more details.



## # TOS

The number of different TOS metrics given for this link, not counting the required link metric (referred to as the TOS 0 metric in [Ref9]). For example, if no additional TOS metrics are given, this field is set to 0.

## metric

The cost of using this router link.

Additional TOS-specific information may also be included, for backward compatibility with previous versions of the OSPF specification ([Ref9]). Within each link, and for each desired TOS, TOS TOS-specific link information may be encoded as follows:

TOS IP Type of Service that this metric refers to. The encoding of TOS in OSPF LSAs is described in Section 12.3.

## TOS metric

TOS-specific metric information.

A.4.3 Network-LSAs

Network-LSAs are the Type 2 LSAs. A network-LSA is originated for each broadcast and NBMA network in the area which supports two or more routers. The network-LSA is originated by the network's Designated Router. The LSA describes all routers attached to the network, including the Designated Router itself. The LSA's Link State ID field lists the IP interface address of the Designated Router.

The distance from the network to all attached routers is zero. This is why metric fields need not be specified in the network-LSA. For details concerning the construction of network-LSAs, see Section 12.4.2.

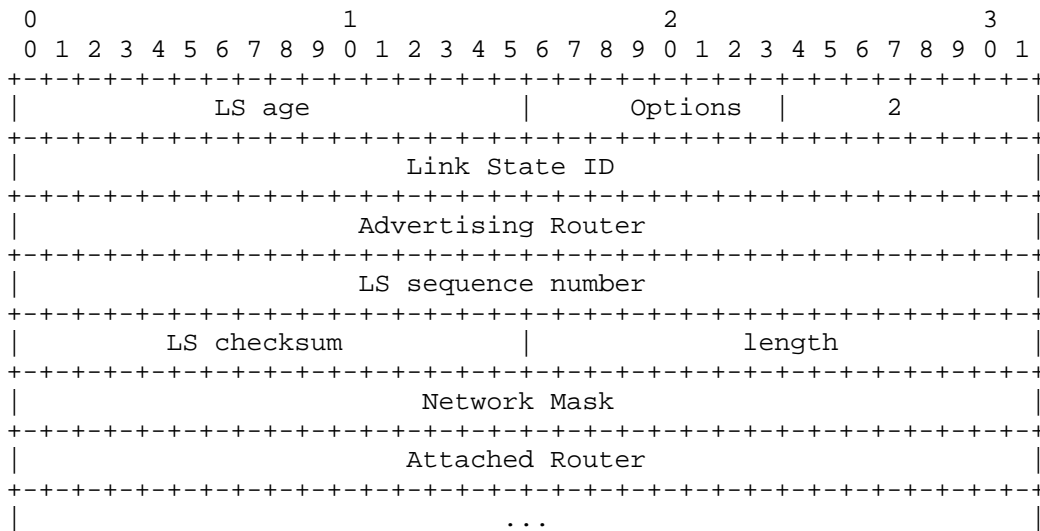

Network Mask

The IP address mask for the network. For example, a class A network would have the mask 0xff000000.

**Attached Router**

The Router IDs of each of the routers attached to the network. Actually, only those routers that are fully adjacent to the Designated Router are listed. The Designated Router includes itself in this list. The number of routers included can be deduced from the LSA header's length field.

A.4.4 Summary-LSAs

Summary-LSAs are the Type 3 and 4 LSAs. These LSAs are originated by area border routers. Summary-LSAs describe inter-area destinations. For details concerning the construction of summary-LSAs, see Section 12.4.3.

Type 3 summary-LSAs are used when the destination is an IP network. In this case the LSA's Link State ID field is an IP network number (if necessary, the Link State ID can also have one or more of the network's "host" bits set; see Appendix E for details). When the destination is an AS boundary router, a Type 4 summary-LSA is used, and the Link State ID field is the AS boundary router's OSPF Router ID. (To see why it is necessary to advertise the location of each ASBR, consult Section 16.4.) Other than the difference in the Link State ID field, the format of Type 3 and 4 summary-LSAs is identical.

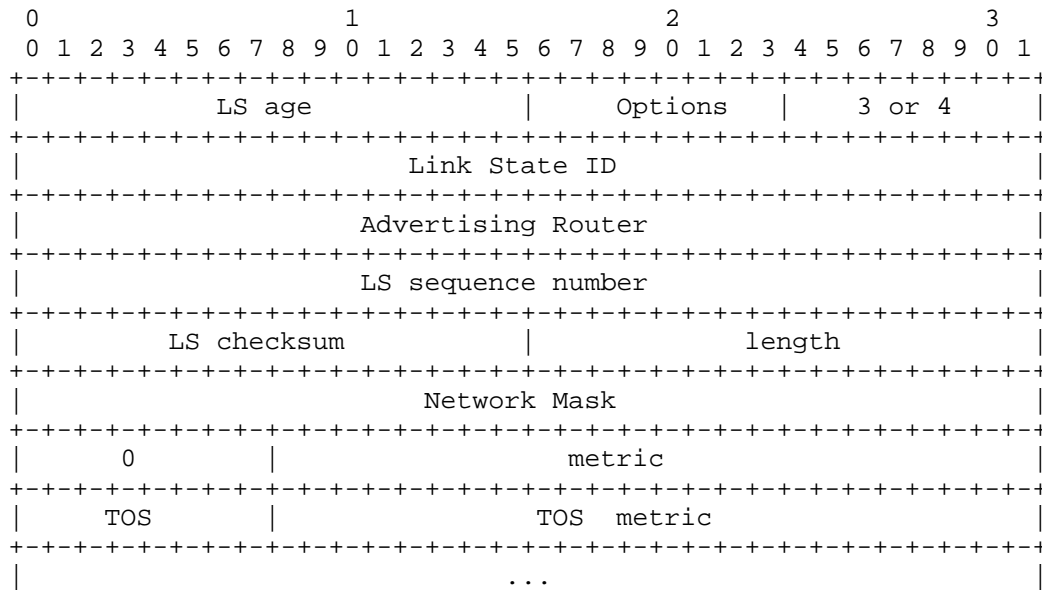

For stub areas, Type 3 summary-LSAs can also be used to describe a (per-area) default route. Default summary routes are used in stub areas instead of flooding a complete set of external routes. When describing a default summary route, the summary-LSA's Link State ID is always set to DefaultDestination (0.0.0.0) and the Network Mask is set to 0.0.0.0.

#### Network Mask

For Type 3 summary-LSAs, this indicates the destination network's IP address mask. For example, when advertising the location of a class A network the value 0xff000000 would be used. This field is not meaningful and must be zero for Type 4 summary-LSAs.

#### metric

The cost of this route. Expressed in the same units as the interface costs in the router-LSAs.

Additional TOS-specific information may also be included, for backward compatibility with previous versions of the OSPF specification ([Ref9]). For each desired TOS, TOS-specific information is encoded as follows:

TOS IP Type of Service that this metric refers to. The encoding of TOS in OSPF LSAs is described in Section 12.3.

#### TOS metric

TOS-specific metric information.

A.4.5 AS-external-LSAs

AS-external-LSAs are the Type 5 LSAs. These LSAs are originated by AS boundary routers, and describe destinations external to the AS. For details concerning the construction of AS-external-LSAs, see Section 12.4.3.

AS-external-LSAs usually describe a particular external destination. For these LSAs the Link State ID field specifies an IP network number (if necessary, the Link State ID can also have one or more of the network's "host" bits set; see Appendix E for details). AS-external-LSAs are also used to describe a default route. Default routes are used when no specific route exists to the destination. When describing a default route, the Link State ID is always set to DefaultDestination (0.0.0.0) and the Network Mask is set to 0.0.0.0.

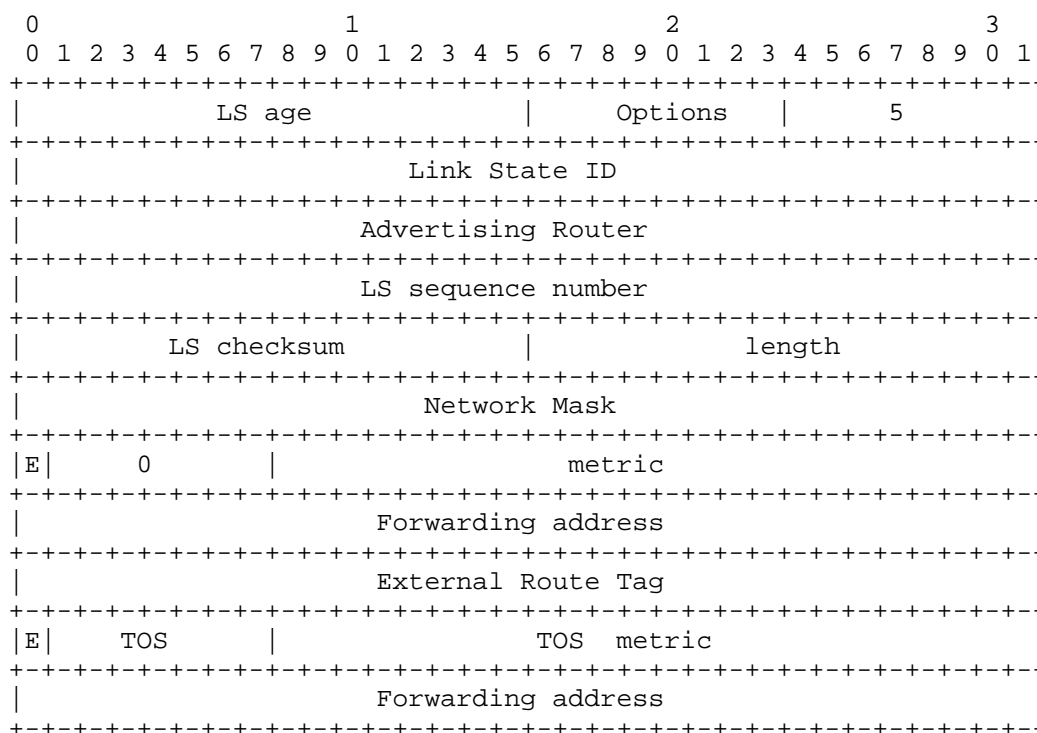



bit E  
For backward-compatibility with [Ref9].

TOS metric  
TOS-specific metric information.

Forwarding address  
For backward-compatibility with [Ref9].

External Route Tag  
For backward-compatibility with [Ref9].



## B. Architectural Constants

Several OSPF protocol parameters have fixed architectural values. These parameters have been referred to in the text by names such as LSRefreshTime. The same naming convention is used for the configurable protocol parameters. They are defined in Appendix C.

The name of each architectural constant follows, together with its value and a short description of its function.

### LSRefreshTime

The maximum time between distinct originations of any particular LSA. If the LS age field of one of the router's self-originated LSAs reaches the value LSRefreshTime, a new instance of the LSA is originated, even though the contents of the LSA (apart from the LSA header) will be the same. The value of LSRefreshTime is set to 30 minutes.

### MinLSInterval

The minimum time between distinct originations of any particular LSA. The value of MinLSInterval is set to 5 seconds.

### MinLSArrival

For any particular LSA, the minimum time that must elapse between reception of new LSA instances during flooding. LSA instances received at higher frequencies are discarded. The value of MinLSArrival is set to 1 second.

### MaxAge

The maximum age that an LSA can attain. When an LSA's LS age field reaches MaxAge, it is reflooded in an attempt to flush the LSA from the routing domain (See Section 14). LSAs of age MaxAge are not used in the routing table calculation. The value of MaxAge is set to 1 hour.

### CheckAge

When the age of an LSA in the link state database hits a multiple of CheckAge, the LSA's checksum is verified. An incorrect checksum at this time indicates a serious error. The value of CheckAge is set to 5 minutes.

**MaxAgeDiff**

The maximum time dispersion that can occur, as an LSA is flooded throughout the AS. Most of this time is accounted for by the LSAs sitting on router output queues (and therefore not aging) during the flooding process. The value of MaxAgeDiff is set to 15 minutes.

**LSInfinity**

The metric value indicating that the destination described by an LSA is unreachable. Used in summary-LSAs and AS-external-LSAs as an alternative to premature aging (see Section 14.1). It is defined to be the 24-bit binary value of all ones: 0xffffffff.

**DefaultDestination**

The Destination ID that indicates the default route. This route is used when no other matching routing table entry can be found. The default destination can only be advertised in AS-external-LSAs and in stub areas' type 3 summary-LSAs. Its value is the IP address 0.0.0.0. Its associated Network Mask is also always 0.0.0.0.

**InitialSequenceNumber**

The value used for LS Sequence Number when originating the first instance of any LSA. Its value is the signed 32-bit integer 0x80000001.

**MaxSequenceNumber**

The maximum value that LS Sequence Number can attain. Its value is the signed 32-bit integer 0x7fffffff.

## C. Configurable Constants

The OSPF protocol has quite a few configurable parameters. These parameters are listed below. They are grouped into general functional categories (area parameters, interface parameters, etc.). Sample values are given for some of the parameters.

Some parameter settings need to be consistent among groups of routers. For example, all routers in an area must agree on that area's parameters, and all routers attached to a network must agree on that network's IP network number and mask.

Some parameters may be determined by router algorithms outside of this specification (e.g., the address of a host connected to the router via a SLIP line). From OSPF's point of view, these items are still configurable.

### C.1 Global parameters

In general, a separate copy of the OSPF protocol is run for each area. Because of this, most configuration parameters are defined on a per-area basis. The few global configuration parameters are listed below.

#### Router ID

This is a 32-bit number that uniquely identifies the router in the Autonomous System. One algorithm for Router ID assignment is to choose the largest or smallest IP address assigned to the router. If a router's OSPF Router ID is changed, the router's OSPF software should be restarted before the new Router ID takes effect. Before restarting in order to change its Router ID, the router should flush its self-originated LSAs from the routing domain (see Section 14.1), or they will persist for up to MaxAge minutes.

#### RFC1583Compatibility

Controls the preference rules used in Section 16.4 when choosing among multiple AS-external-LSAs advertising the same destination. When set to "enabled", the preference rules remain those specified by RFC 1583 ([Ref9]). When set to "disabled", the preference rules are those stated in

Section 16.4.1, which prevent routing loops when AS-external-LSAs for the same destination have been originated from different areas. Set to "enabled" by default.

In order to minimize the chance of routing loops, all OSPF routers in an OSPF routing domain should have RFC1583Compatibility set identically. When there are routers present that have not been updated with the functionality specified in Section 16.4.1 of this memo, all routers should have RFC1583Compatibility set to "enabled". Otherwise, all routers should have RFC1583Compatibility set to "disabled", preventing all routing loops.

## C.2 Area parameters

All routers belonging to an area must agree on that area's configuration. Disagreements between two routers will lead to an inability for adjacencies to form between them, with a resulting hindrance to the flow of routing protocol and data traffic. The following items must be configured for an area:

### Area ID

This is a 32-bit number that identifies the area. The Area ID of 0.0.0.0 is reserved for the backbone. If the area represents a subnetted network, the IP network number of the subnetted network may be used for the Area ID.

### List of address ranges

An OSPF area is defined as a list of address ranges. Each address range consists of the following items:

#### [IP address, mask]

Describes the collection of IP addresses contained in the address range. Networks and hosts are assigned to an area depending on whether their addresses fall into one of the area's defining address ranges. Routers are viewed as belonging to multiple areas, depending on their attached networks' area membership.

Status Set to either Advertise or DoNotAdvertise. Routing information is condensed at area boundaries. External to the area, at most a single route is advertised (via a summary-LSA) for each address range. The route is advertised if and only if the address range's Status is set to Advertise. Unadvertised ranges allow the existence of certain networks to be intentionally hidden from other areas. Status is set to Advertise by default.

As an example, suppose an IP subnetted network is to be its own OSPF area. The area would be configured as a single address range, whose IP address is the address of the subnetted network, and whose mask is the natural class A, B, or C address mask. A single route would be advertised external to the area, describing the entire subnetted network.

#### ExternalRoutingCapability

Whether AS-external-LSAs will be flooded into/throughout the area. If AS-external-LSAs are excluded from the area, the area is called a "stub". Internal to stub areas, routing to external destinations will be based solely on a default summary route. The backbone cannot be configured as a stub area. Also, virtual links cannot be configured through stub areas. For more information, see Section 3.6.

#### StubDefaultCost

If the area has been configured as a stub area, and the router itself is an area border router, then the StubDefaultCost indicates the cost of the default summary-LSA that the router should advertise into the area.

### C.3 Router interface parameters

Some of the configurable router interface parameters (such as IP interface address and subnet mask) actually imply properties of the attached networks, and therefore must be consistent across all the routers attached to that network. The parameters that must be configured for a router interface are:

**IP interface address**

The IP protocol address for this interface. This uniquely identifies the router over the entire internet. An IP address is not required on point-to-point networks. Such a point-to-point network is called "unnumbered".

**IP interface mask**

Also referred to as the subnet/network mask, this indicates the portion of the IP interface address that identifies the attached network. Masking the IP interface address with the IP interface mask yields the IP network number of the attached network. On point-to-point networks and virtual links, the IP interface mask is not defined. On these networks, the link itself is not assigned an IP network number, and so the addresses of each side of the link are assigned independently, if they are assigned at all.

**Area ID**

The OSPF area to which the attached network belongs.

**Interface output cost**

The cost of sending a packet on the interface, expressed in the link state metric. This is advertised as the link cost for this interface in the router's router-LSA. The interface output cost must always be greater than 0.

**RxmtInterval**

The number of seconds between LSA retransmissions, for adjacencies belonging to this interface. Also used when retransmitting Database Description and Link State Request Packets. This should be well over the expected round-trip delay between any two routers on the attached network. The setting of this value should be conservative or needless retransmissions will result. Sample value for a local area network: 5 seconds.

**InfTransDelay**

The estimated number of seconds it takes to transmit a Link State Update Packet over this interface. LSAs contained in the update packet must have their age incremented by this amount before transmission. This value should take into account the transmission and propagation delays of the

interface. It must be greater than 0. Sample value for a local area network: 1 second.

#### Router Priority

An 8-bit unsigned integer. When two routers attached to a network both attempt to become Designated Router, the one with the highest Router Priority takes precedence. If there is still a tie, the router with the highest Router ID takes precedence. A router whose Router Priority is set to 0 is ineligible to become Designated Router on the attached network. Router Priority is only configured for interfaces to broadcast and NBMA networks.

#### HelloInterval

The length of time, in seconds, between the Hello Packets that the router sends on the interface. This value is advertised in the router's Hello Packets. It must be the same for all routers attached to a common network. The smaller the HelloInterval, the faster topological changes will be detected; however, more OSPF routing protocol traffic will ensue. Sample value for a X.25 PDN network: 30 seconds. Sample value for a local area network: 10 seconds.

#### RouterDeadInterval

After ceasing to hear a router's Hello Packets, the number of seconds before its neighbors declare the router down. This is also advertised in the router's Hello Packets in their RouterDeadInterval field. This should be some multiple of the HelloInterval (say 4). This value again must be the same for all routers attached to a common network.

#### AuType

Identifies the authentication procedure to be used on the attached network. This value must be the same for all routers attached to the network. See Appendix D for a discussion of the defined authentication types.

#### Authentication key

This configured data allows the authentication procedure to verify OSPF protocol packets received over the interface. For example, if the AuType indicates simple password, the

Authentication key would be a clear 64-bit password. Authentication keys associated with the other OSPF authentication types are discussed in Appendix D.

#### C.4 Virtual link parameters

Virtual links are used to restore/increase connectivity of the backbone. Virtual links may be configured between any pair of area border routers having interfaces to a common (non-backbone) area. The virtual link appears as an unnumbered point-to-point link in the graph for the backbone. The virtual link must be configured in both of the area border routers.

A virtual link appears in router-LSAs (for the backbone) as if it were a separate router interface to the backbone. As such, it has all of the parameters associated with a router interface (see Section C.3). Although a virtual link acts like an unnumbered point-to-point link, it does have an associated IP interface address. This address is used as the IP source in OSPF protocol packets it sends along the virtual link, and is set dynamically during the routing table build process. Interface output cost is also set dynamically on virtual links to be the cost of the intra-area path between the two routers. The parameter RxmtInterval must be configured, and should be well over the expected round-trip delay between the two routers. This may be hard to estimate for a virtual link; it is better to err on the side of making it too large. Router Priority is not used on virtual links.

A virtual link is defined by the following two configurable parameters: the Router ID of the virtual link's other endpoint, and the (non-backbone) area through which the virtual link runs (referred to as the virtual link's Transit area). Virtual links cannot be configured through stub areas.

#### C.5 NBMA network parameters

OSPF treats an NBMA network much like it treats a broadcast network. Since there may be many routers attached to the network, a Designated Router is selected for the network. This Designated Router then originates a network-LSA, which lists all routers attached to the NBMA network.



However, due to the lack of broadcast capabilities, it may be necessary to use configuration parameters in the Designated Router selection. These parameters will only need to be configured in those routers that are themselves eligible to become Designated Router (i.e., those router's whose Router Priority for the network is non-zero), and then only if no automatic procedure for discovering neighbors exists:

#### List of all other attached routers

The list of all other routers attached to the NBMA network. Each router is listed by its IP interface address on the network. Also, for each router listed, that router's eligibility to become Designated Router must be defined. When an interface to a NBMA network comes up, the router sends Hello Packets only to those neighbors eligible to become Designated Router, until the identity of the Designated Router is discovered.

#### PollInterval

If a neighboring router has become inactive (Hello Packets have not been seen for RouterDeadInterval seconds), it may still be necessary to send Hello Packets to the dead neighbor. These Hello Packets will be sent at the reduced rate PollInterval, which should be much larger than HelloInterval. Sample value for a PDN X.25 network: 2 minutes.

### C.6 Point-to-MultiPoint network parameters

On Point-to-MultiPoint networks, it may be necessary to configure the set of neighbors that are directly reachable over the Point-to-MultiPoint network. Each neighbor is identified by its IP address on the Point-to-MultiPoint network. Designated Routers are not elected on Point-to-MultiPoint networks, so the Designated Router eligibility of configured neighbors is undefined.

Alternatively, neighbors on Point-to-MultiPoint networks may be dynamically discovered by lower-level protocols such as Inverse ARP ([Ref14]).

### C.7 Host route parameters

Host routes are advertised in router-LSAs as stub networks with mask 0xffffffff. They indicate either router interfaces to point-to-point networks, looped router interfaces, or IP hosts that are directly connected to the router (e.g., via a SLIP line). For each host directly connected to the router, the following items must be configured:

#### Host IP address

The IP address of the host.

#### Cost of link to host

The cost of sending a packet to the host, in terms of the link state metric. However, since the host probably has only a single connection to the internet, the actual configured cost in many cases is unimportant (i.e., will have no effect on routing).

#### Area ID

The OSPF area to which the host belongs.

## D. Authentication

All OSPF protocol exchanges are authenticated. The OSPF packet header (see Section A.3.1) includes an authentication type field, and 64-bits of data for use by the appropriate authentication scheme (determined by the type field).

The authentication type is configurable on a per-interface (or equivalently, on a per-network/subnet) basis. Additional authentication data is also configurable on a per-interface basis.

Authentication types 0, 1 and 2 are defined by this specification. All other authentication types are reserved for definition by the IANA (iana@ISI.EDU). The current list of authentication types is described below in Table 20.

AuType	Description
0	Null authentication
1	Simple password
2	Cryptographic authentication
All others	Reserved for assignment by the IANA (iana@ISI.EDU)

Table 20: OSPF authentication types.

### D.1 Null authentication

Use of this authentication type means that routing exchanges over the network/subnet are not authenticated. The 64-bit authentication field in the OSPF header can contain anything; it is not examined on packet reception. When employing Null authentication, the entire contents of each OSPF packet (other than the 64-bit authentication field) are checksummed in order to detect data corruption.

## D.2 Simple password authentication

Using this authentication type, a 64-bit field is configured on a per-network basis. All packets sent on a particular network must have this configured value in their OSPF header 64-bit authentication field. This essentially serves as a "clear" 64-bit password. In addition, the entire contents of each OSPF packet (other than the 64-bit authentication field) are checksummed in order to detect data corruption.

Simple password authentication guards against routers inadvertently joining the routing domain; each router must first be configured with its attached networks' passwords before it can participate in routing. However, simple password authentication is vulnerable to passive attacks currently widespread in the Internet (see [Ref16]). Anyone with physical access to the network can learn the password and compromise the security of the OSPF routing domain.

## D.3 Cryptographic authentication

Using this authentication type, a shared secret key is configured in all routers attached to a common network/subnet. For each OSPF protocol packet, the key is used to generate/verify a "message digest" that is appended to the end of the OSPF packet. The message digest is a one-way function of the OSPF protocol packet and the secret key. Since the secret key is never sent over the network in the clear, protection is provided against passive attacks.

The algorithms used to generate and verify the message digest are specified implicitly by the secret key. This specification completely defines the use of OSPF Cryptographic authentication when the MD5 algorithm is used.

In addition, a non-decreasing sequence number is included in each OSPF protocol packet to protect against replay attacks. This provides long term protection; however, it is still possible to replay an OSPF packet until the sequence number changes. To implement this feature, each neighbor data structure contains a new field called the "cryptographic sequence number". This field is initialized to zero, and is also set to zero

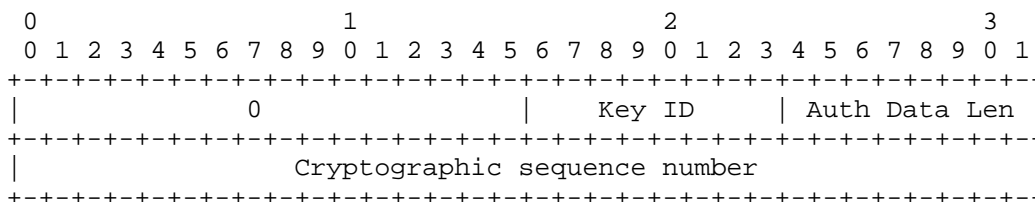

Figure 18: Usage of the Authentication field in the OSPF packet header when Cryptographic Authentication is employed

whenever the neighbor's state transitions to "Down". Whenever an OSPF packet is accepted as authentic, the cryptographic sequence number is set to the received packet's sequence number.

This specification does not provide a rollover procedure for the cryptographic sequence number. When the cryptographic sequence number that the router is sending hits the maximum value, the router should reset the cryptographic sequence number that it is sending back to 0. After this is done, the router's neighbors will reject the router's OSPF packets for a period of RouterDeadInterval, and then the router will be forced to reestablish all adjacencies over the interface. However, it is expected that many implementations will use "seconds since reboot" (or "seconds since 1960", etc.) as the cryptographic sequence number. Such a choice will essentially prevent rollover, since the cryptographic sequence number field is 32 bits in length.

The OSPF Cryptographic authentication option does not provide confidentiality.

When cryptographic authentication is used, the 64-bit Authentication field in the standard OSPF packet header is redefined as shown in Figure 18. The new field definitions are as follows:

**Key ID**

This field identifies the algorithm and secret key used to create the message digest appended to the OSPF packet. Key Identifiers are unique per-interface (or equivalently, per-subnet).

**Auth Data Len**

The length in bytes of the message digest appended to the OSPF packet.

**Cryptographic sequence number**

An unsigned 32-bit non-decreasing sequence number. Used to guard against replay attacks.

The message digest appended to the OSPF packet is not actually considered part of the OSPF protocol packet: the message digest is not included in the OSPF header's packet length, although it is included in the packet's IP header length field.

Each key is identified by the combination of interface and Key ID. An interface may have multiple keys active at any one time. This enables smooth transition from one key to another. Each key has four time constants associated with it. These time constants can be expressed in terms of a time-of-day clock, or in terms of a router's local clock (e.g., number of seconds since last reboot):

**KeyStartAccept**

The time that the router will start accepting packets that have been created with the given key.

**KeyStartGenerate**

The time that the router will start using the key for packet generation.

**KeyStopGenerate**

The time that the router will stop using the key for packet generation.

**KeyStopAccept**

The time that the router will stop accepting packets that have been created with the given key.

In order to achieve smooth key transition, KeyStartAccept should be less than KeyStartGenerate and KeyStopGenerate should be less than KeyStopAccept. If KeyStopGenerate and KeyStopAccept are left unspecified, the key's lifetime is infinite. When a new key replaces an old, the KeyStartGenerate time for the new key must be less than or equal to the KeyStopGenerate time of the old key.

Key storage should persist across a system restart, warm or cold, to avoid operational issues. In the event that the last key associated with an interface expires, it is unacceptable to revert to an unauthenticated condition, and not advisable to disrupt routing. Therefore, the router should send a "last authentication key expiration" notification to the network manager and treat the key as having an infinite lifetime until the lifetime is extended, the key is deleted by network management, or a new key is configured.

#### D.4 Message generation

After building the contents of an OSPF packet, the authentication procedure indicated by the sending interface's Autype value is called before the packet is sent. The authentication procedure modifies the OSPF packet as follows.

##### D.4.1 Generating Null authentication

When using Null authentication, the packet is modified as follows:

- (1) The Autype field in the standard OSPF header is set to 0.
- (2) The checksum field in the standard OSPF header is set to the standard IP checksum of the entire contents of the packet, starting with the OSPF packet header but excluding the 64-bit authentication field. This checksum is calculated as the 16-bit one's complement of the one's complement sum of all the 16-bit words in the packet, excepting the authentication field. If the

packet's length is not an integral number of 16-bit words, the packet is padded with a byte of zero before checksumming.

#### D.4.2 Generating Simple password authentication

When using Simple password authentication, the packet is modified as follows:

- (1) The Autype field in the standard OSPF header is set to 1.
- (2) The checksum field in the standard OSPF header is set to the standard IP checksum of the entire contents of the packet, starting with the OSPF packet header but excluding the 64-bit authentication field. This checksum is calculated as the 16-bit one's complement of the one's complement sum of all the 16-bit words in the packet, excepting the authentication field. If the packet's length is not an integral number of 16-bit words, the packet is padded with a byte of zero before checksumming.
- (3) The 64-bit authentication field in the OSPF packet header is set to the 64-bit password (i.e., authentication key) that has been configured for the interface.

#### D.4.3 Generating Cryptographic authentication

When using Cryptographic authentication, there may be multiple keys configured for the interface. In this case, among the keys that are valid for message generation (i.e., that have  $\text{KeyStartGenerate} \leq \text{current time} < \text{KeyStopGenerate}$ ) choose the one with the most recent  $\text{KeyStartGenerate}$  time. Using this key, modify the packet as follows:

- (1) The Autype field in the standard OSPF header is set to 2.



- (2) The checksum field in the standard OSPF header is not calculated, but is instead set to 0.
- (3) The Key ID (see Figure 18) is set to the chosen key's Key ID.
- (4) The Auth Data Len field is set to the length in bytes of the message digest that will be appended to the OSPF packet. When using MD5 as the authentication algorithm, Auth Data Len will be 16.
- (5) The 32-bit Cryptographic sequence number (see Figure 18) is set to a non-decreasing value (i.e., a value at least as large as the last value sent out the interface). The precise values to use in the cryptographic sequence number field are implementation-specific. For example, it may be based on a simple counter, or be based on the system's clock.
- (6) The message digest is then calculated and appended to the OSPF packet. The authentication algorithm to be used in calculating the digest is indicated by the key itself. Input to the authentication algorithm consists of the OSPF packet and the secret key. When using MD5 as the authentication algorithm, the message digest calculation proceeds as follows:
  - (a) The 16 byte MD5 key is appended to the OSPF packet.
  - (b) Trailing pad and length fields are added, as specified in [Ref17].
  - (c) The MD5 authentication algorithm is run over the concatenation of the OSPF packet, secret key, pad and length fields, producing a 16 byte message digest (see [Ref17]).
  - (d) The MD5 digest is written over the OSPF key (i.e., appended to the original OSPF packet). The digest is not counted in the OSPF packet's length field, but

is included in the packet's IP length field. Any trailing pad or length fields beyond the digest are not counted or transmitted.

#### D.5 Message verification

When an OSPF packet has been received on an interface, it must be authenticated. The authentication procedure is indicated by the setting of Autype in the standard OSPF packet header, which matches the setting of Autype for the receiving OSPF interface.

If an OSPF protocol packet is accepted as authentic, processing of the packet continues as specified in Section 8.2. Packets which fail authentication are discarded.

##### D.5.1 Verifying Null authentication

When using Null authentication, the checksum field in the OSPF header must be verified. It must be set to the 16-bit one's complement of the one's complement sum of all the 16-bit words in the packet, excepting the authentication field. (If the packet's length is not an integral number of 16-bit words, the packet is padded with a byte of zero before checksumming.)

##### D.5.2 Verifying Simple password authentication

When using Simple password authentication, the received OSPF packet is authenticated as follows:

- (1) The checksum field in the OSPF header must be verified. It must be set to the 16-bit one's complement of the one's complement sum of all the 16-bit words in the packet, excepting the authentication field. (If the packet's length is not an integral number of 16-bit words, the packet is padded with a byte of zero before checksumming.)
- (2) The 64-bit authentication field in the OSPF packet header must be equal to the 64-bit password (i.e., authentication key) that has been configured for the interface.

### D.5.3 Verifying Cryptographic authentication

When using Cryptographic authentication, the received OSPF packet is authenticated as follows:

- (1) Locate the receiving interface's configured key having Key ID equal to that specified in the received OSPF packet (see Figure 18). If the key is not found, or if the key is not valid for reception (i.e., current time < KeyStartAccept or current time >= KeyStopAccept), the OSPF packet is discarded.
- (2) If the cryptographic sequence number found in the OSPF header (see Figure 18) is less than the cryptographic sequence number recorded in the sending neighbor's data structure, the OSPF packet is discarded.
- (3) Verify the appended message digest in the following steps:
  - (a) The received digest is set aside.
  - (b) A new digest is calculated, as specified in Step 6 of Section D.4.3.
  - (c) The calculated and received digests are compared. If they do not match, the OSPF packet is discarded. If they do match, the OSPF protocol packet is accepted as authentic, and the "cryptographic sequence number" in the neighbor's data structure is set to the sequence number found in the packet's OSPF header.

#### E. An algorithm for assigning Link State IDs

The Link State ID in AS-external-LSAs and summary-LSAs is usually set to the described network's IP address. However, if necessary one or more of the network's host bits may be set in the Link State ID. This allows the router to originate separate LSAs for networks having the same address, yet different masks. Such networks can occur in the presence of supernetting and subnet 0s (see [Ref10]).

This appendix gives one possible algorithm for setting the host bits in Link State IDs. The choice of such an algorithm is a local decision. Separate routers are free to use different algorithms, since the only LSAs affected are the ones that the router itself originates. The only requirement on the algorithms used is that the network's IP address should be used as the Link State ID whenever possible; this maximizes interoperability with OSPF implementations predating RFC 1583.

The algorithm below is stated for AS-external-LSAs. This is only for clarity; the exact same algorithm can be used for summary-LSAs. Suppose that the router wishes to originate an AS-external-LSA for a network having address NA and mask NM1. The following steps are then used to determine the LSA's Link State ID:

- (1) Determine whether the router is already originating an AS-external-LSA with Link State ID equal to NA (in such an LSA the router itself will be listed as the LSA's Advertising Router). If not, the Link State ID is set equal to NA and the algorithm terminates. Otherwise,
- (2) Obtain the network mask from the body of the already existing AS-external-LSA. Call this mask NM2. There are then two cases:
  - o NM1 is longer (i.e., more specific) than NM2. In this case, set the Link State ID in the new LSA to be the network [NA,NM1] with all the host bits set (i.e., equal to NA or'ed together with all the bits that are not set in NM1, which is network [NA,NM1]'s broadcast address).
  - o NM2 is longer than NM1. In this case, change the existing LSA (having Link State ID of NA) to reference the new network [NA,NM1] by incrementing the sequence number,

changing the mask in the body to NM1 and inserting the cost of the new network. Then originate a new LSA for the old network [NA,NM2], with Link State ID equal to NA or'ed together with the bits that are not set in NM2 (i.e., network [NA,NM2]'s broadcast address).

The above algorithm assumes that all masks are contiguous; this ensures that when two networks have the same address, one mask is more specific than the other. The algorithm also assumes that no network exists having an address equal to another network's broadcast address. Given these two assumptions, the above algorithm always produces unique Link State IDs. The above algorithm can also be reworded as follows: When originating an AS-external-LSA, try to use the network number as the Link State ID. If that produces a conflict, examine the two networks in conflict. One will be a subset of the other. For the less specific network, use the network number as the Link State ID and for the more specific use the network's broadcast address instead (i.e., flip all the "host" bits to 1). If the most specific network was originated first, this will cause you to originate two LSAs at once.

As an example of the algorithm, consider its operation when the following sequence of events occurs in a single router (Router A).

- (1) Router A wants to originate an AS-external-LSA for [10.0.0.0,255.255.255.0]:
  - (a) A Link State ID of 10.0.0.0 is used.
- (2) Router A then wants to originate an AS-external-LSA for [10.0.0.0,255.255.0.0]:
  - (a) The LSA for [10.0.0.0,255.255.255.0] is reoriginated using a new Link State ID of 10.0.0.255.
  - (b) A Link State ID of 10.0.0.0 is used for [10.0.0.0,255.255.0.0].
- (3) Router A then wants to originate an AS-external-LSA for [10.0.0.0,255.0.0.0]:

- (a) The LSA for [10.0.0.0,255.255.0.0] is reoriginated using a new Link State ID of 10.0.255.255.
- (b) A Link State ID of 10.0.0.0 is used for [10.0.0.0,255.0.0.0].
- (c) The network [10.0.0.0,255.255.255.0] keeps its Link State ID of 10.0.0.255.

## F. Multiple interfaces to the same network/subnet

There are at least two ways to support multiple physical interfaces to the same IP subnet. Both methods will interoperate with implementations of RFC 1583 (and of course this memo). The two methods are sketched briefly below. An assumption has been made that each interface has been assigned a separate IP address (otherwise, support for multiple interfaces is more of a link-level or ARP issue than an OSPF issue).

## Method 1:

Run the entire OSPF functionality over both interfaces, sending and receiving hellos, flooding, supporting separate interface and neighbor FSMs for each interface, etc. When doing this all other routers on the subnet will treat the two interfaces as separate neighbors, since neighbors are identified (on broadcast and NBMA networks) by their IP address.

Method 1 has the following disadvantages:

- (1) You increase the total number of neighbors and adjacencies.
- (2) You lose the bidirectionality test on both interfaces, since bidirectionality is based on Router ID.
- (3) You have to consider both interfaces together during the Designated Router election, since if you declare both to be DR simultaneously you can confuse the tie-breaker (which is Router ID).

## Method 2:

Run OSPF over only one interface (call it the primary interface), but include both the primary and secondary interfaces in your Router-LSA.

Method 2 has the following disadvantages:

- (1) You lose the bidirectionality test on the secondary interface.
- (2) When the primary interface fails, you need to promote the secondary interface to primary status.

## G. Differences from RFC 2178

This section documents the differences between this memo and RFC 2178. All differences are backward-compatible. Implementations of this memo and of RFCs 2178, 1583, and 1247 will interoperate.

### G.1 Flooding modifications

Three changes have been made to the flooding procedure in Section 13.

The first change is to step 4 in Section 13. Now MaxAge LSAs are acknowledged and then discarded only when both a) there is no database copy of the LSA and b) none of router's neighbors are in states Exchange or Loading. In all other cases, the MaxAge LSA is processed like any other LSA, installing the LSA in the database and flooding it out the appropriate interfaces when the LSA is more recent than the database copy (Step 5 of Section 13). This change also affects the contents of Table 19.

The second change is to step 5a in Section 13. The MinLSArrival check is meant only for LSAs received during flooding, and should not be performed on those LSAs that the router itself originates.

The third change is to step 8 in Section 13. Confusion between routers as to which LSA instance is more recent can cause a disastrous amount of flooding in a link-state protocol (see [Ref26]). OSPF guards against this problem in two ways: a) the LS age field is used like a TTL field in flooding, to eventually remove looping LSAs from the network (see Section 13.3), and b) routers refuse to accept LSA updates more frequently than once every MinLSArrival seconds (see Section 13). However, there is still one case in RFC 2178 where disagreements regarding which LSA is more recent can cause a lot of flooding traffic: responding to old LSAs by reflooding the database copy. For this reason, Step 8 of Section 13 has been amended to only respond with the database copy when that copy has not been sent in any Link State Update within the last MinLSArrival seconds.



## G.2 Changes to external path preferences

There is still the possibility of a routing loop in RFC 2178 when both a) virtual links are in use and b) the same external route is being imported by multiple ASBRs, each of which is in a separate area. To fix this problem, Section 16.4.1 has been revised. To choose the correct ASBR/forwarding address, intra-area paths through non-backbone areas are always preferred. However, intra-area paths through the backbone area (Area 0) and inter-area paths are now of equal preference, and must be compared solely based on cost.

The reasoning behind this change is as follows. When virtual links are in use, an intra-area backbone path for one router can turn into an inter-area path in a router several hops closer to the destination. Hence, intra-area backbone paths and inter-area paths must be of equal preference. We can safely compare their costs, preferring the path with the smallest cost, due to the calculations in Section 16.3.

Thanks to Michael Briggs and Jeremy McCooley of the UNH InterOperability Lab for pointing out this problem.

## G.3 Incomplete resolution of virtual next hops

One of the functions of the calculation in Section 16.3 is to determine the actual next hop(s) for those destinations whose next hop was calculated as a virtual link in Sections 16.1 and 16.2. After completion of the calculation in Section 16.3, any paths calculated in Sections 16.1 and 16.2 that still have unresolved virtual next hops should be discarded.

## G.4 Routing table lookup

The routing table lookup algorithm in Section 11.1 has been modified to reflect current practice. The "best match" routing table entry is now always selected to be the one providing the most specific (longest) match. Suppose for example a router is forwarding packets to the destination 192.9.1.1. A routing table entry for 192.9.1/24 will always be a better match than the routing table entry for 192.9/16, regardless of the routing table entries' path-types. Note however that when multiple paths

are available for a given routing table entry, the calculations in Sections 16.1, 16.2, and 16.4 always yield the paths having the most preferential path-type. (Intra-area paths are the most preferred, followed in order by inter-area, type 1 external and type 2 external paths; see Section 11).

## Security Considerations

All OSPF protocol exchanges are authenticated. OSPF supports multiple types of authentication; the type of authentication in use can be configured on a per network segment basis. One of OSPF's authentication types, namely the Cryptographic authentication option, is believed to be secure against passive attacks and provide significant protection against active attacks. When using the Cryptographic authentication option, each router appends a "message digest" to its transmitted OSPF packets. Receivers then use the shared secret key and received digest to verify that each received OSPF packet is authentic.

The quality of the security provided by the Cryptographic authentication option depends completely on the strength of the message digest algorithm (MD5 is currently the only message digest algorithm specified), the strength of the key being used, and the correct implementation of the security mechanism in all communicating OSPF implementations. It also requires that all parties maintain the secrecy of the shared secret key.

None of the OSPF authentication types provide confidentiality. Nor do they protect against traffic analysis. Key management is also not addressed by this memo.

For more information, see Sections 8.1, 8.2, and Appendix D.

## Author's Address

John Moy  
Ascend Communications, Inc.  
1 Robbins Road  
Westford, MA 01886

Phone: 978-952-1367  
Fax: 978-392-2075  
EMail: jmoy@casc.com

## Full Copyright Statement

Copyright (C) The Internet Society (1998). All Rights Reserved.

This document and translations of it may be copied and furnished to others, and derivative works that comment on or otherwise explain it or assist in its implementation may be prepared, copied, published and distributed, in whole or in part, without restriction of any kind, provided that the above copyright notice and this paragraph are included on all such copies and derivative works. However, this document itself may not be modified in any way, such as by removing the copyright notice or references to the Internet Society or other Internet organizations, except as needed for the purpose of developing Internet standards in which case the procedures for copyrights defined in the Internet Standards process must be followed, or as required to translate it into languages other than English.

The limited permissions granted above are perpetual and will not be revoked by the Internet Society or its successors or assigns.

This document and the information contained herein is provided on an "AS IS" basis and THE INTERNET SOCIETY AND THE INTERNET ENGINEERING TASK FORCE DISCLAIMS ALL WARRANTIES, EXPRESS OR IMPLIED, INCLUDING BUT NOT LIMITED TO ANY WARRANTY THAT THE USE OF THE INFORMATION HEREIN WILL NOT INFRINGE ANY RIGHTS OR ANY IMPLIED WARRANTIES OF MERCHANTABILITY OR FITNESS FOR A PARTICULAR PURPOSE.