Collaborative transmission in wireless sensor networks

Distributed Adaptive Beamforming

Stephan Sigg

Institute of Distributed and Ubiquitous Systems
Technische Universität Braunschweig

November 29, 2010

Overview and Structure

- Introduction to context aware computing
- Wireless sensor networks
- Wireless communications
- Basics of probability theory
- Randomised search approaches
- Cooperative transmission schemes
- Distributed adaptive beamforming
 - Feedback based approaches
 - Asymptotic bounds on the synchronisation time
 - Alternative algorithmic approaches
 - Alternative Optimisation environments

Overview and Structure

- Introduction to context aware computing
- Wireless sensor networks
- Wireless communications
- Basics of probability theory
- Randomised search approaches
- Cooperative transmission schemes
- **Distributed adaptive beamforming**
 - **Feedback based approaches**
 - Asymptotic bounds on the synchronisation time
 - Alternative algorithmic approaches
 - Alternative Optimisation environments

Outline

Feedback based distr. adaptive beamforming

- 1 Analysis of the problem scenario
 - Individual representation
 - Fitness function
 - Search space
 - Variation operators
- 2 Analysis of the convergence time
 - An upper bound on the synchronisation performance
 - A lower bound on the synchronisation performance
- 3 Simulation and experimental results for the basic scenario
 - Impact of distinct parameter configurations
 - Impact of environmental parameters
 - Impact of algorithmic modifications

Feedback based distr. adaptive beamforming

Introduction

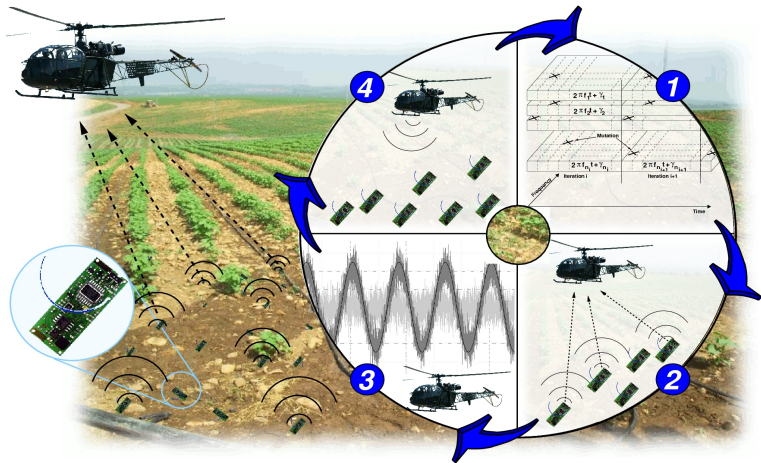

Feedback based distr. adaptive beamforming

Introduction



- 1-bit feedback based closed loop carrier synchronisation
 - Slow synchronisation
 - But: Computationally modest demands
 - Only: Adaptation of carrier phase based on binary feedback value
- Therefore: Well suited to be applied for WSNs

Feedback based distr. adaptive beamforming

Introduction

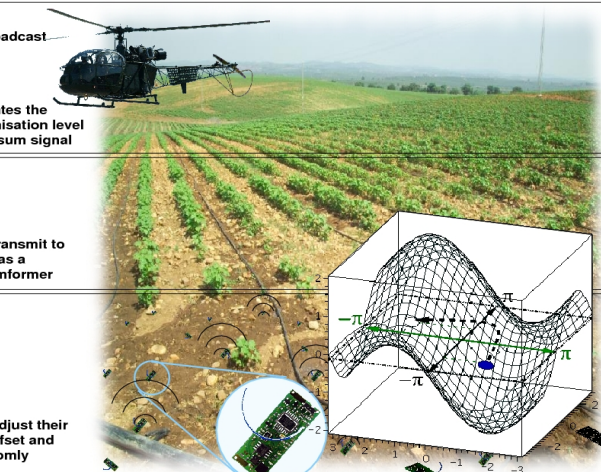

Phase 4:
Feedback is broadcast to the network

Phase 3:
Receiver estimates the phase synchronisation level of the received sum signal

Phase 2:
Source nodes transmit to the destination as a distributed beamformer

Phase 1:
Source nodes adjust their carrier phase offset and frequency randomly

Feedback based distr. adaptive beamforming

Introduction

Phase 4:

Feedback is broadcast to the network

Phase 3:

Receiver estimates the phase synchronisation level of the received sum signal

Phase 2:

Source nodes transmit to the destination as a distributed beamformer

Phase 1:

Source nodes adjust their carrier phase offset and frequency randomly



Feedback based distr. adaptive beamforming

Introduction

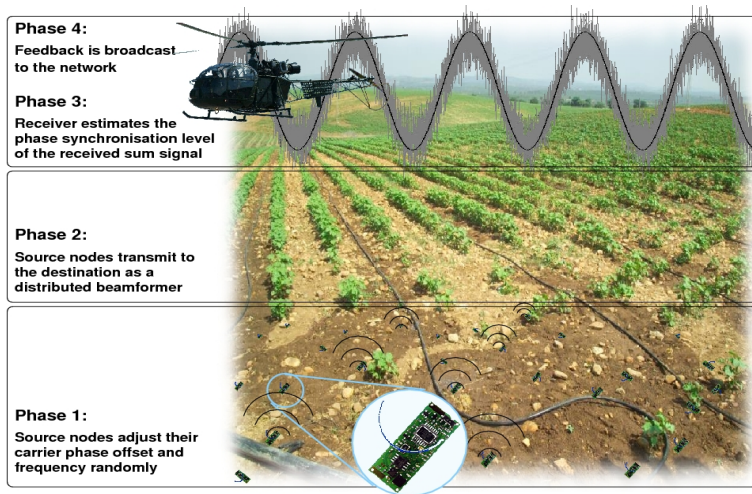

Feedback based distr. adaptive beamforming

Introduction

Phase 4:

Feedback is broadcast
to the network

Phase 3:

Receiver estimates the
phase synchronisation level
of the received sum signal

Phase 2:

Source nodes transmit to
the destination as a
distributed beamformer

Phase 1:

Source nodes adjust their
carrier phase offset and
frequency randomly



Feedback based distr. adaptive beamforming

Introduction

Phase 4:

Feedback is broadcast to the network

Phase 3:

Receiver estimates the phase synchronisation level of the received sum signal

Phase 2:

Source nodes transmit to the destination as a distributed beamformer

Phase 1:

Source nodes adjust their carrier phase offset and frequency randomly

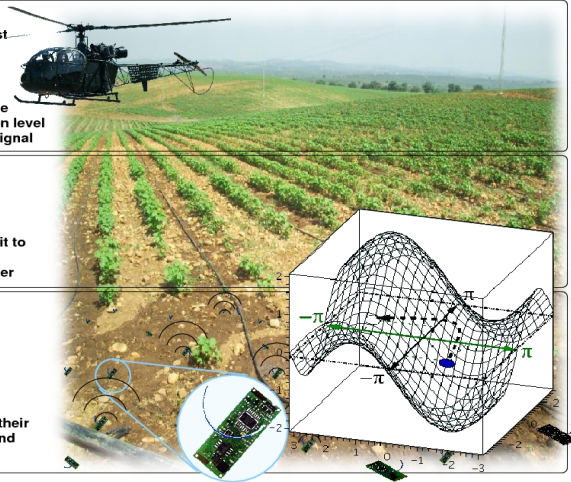

Feedback based distr. adaptive beamforming

Introduction



- Analysis of the underlying algorithmic problem
 - Precise mathematical understanding of the problem required
 - Modelling of
 - Search space
 - Optimisation aim
 - Representation of search points
 - Parameters that impact the synchronisation performance

Outline

Feedback based distr. adaptive beamforming

- 1 Analysis of the problem scenario
 - Individual representation
 - Fitness function
 - Search space
 - Variation operators
- 2 Analysis of the convergence time
 - An upper bound on the synchronisation performance
 - A lower bound on the synchronisation performance
- 3 Simulation and experimental results for the basic scenario
 - Impact of distinct parameter configurations
 - Impact of environmental parameters
 - Impact of algorithmic modifications

Feedback based distr. adaptive beamforming

Analysis of the problem scenario

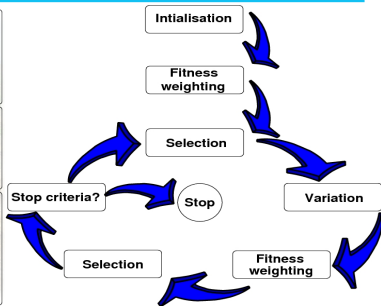
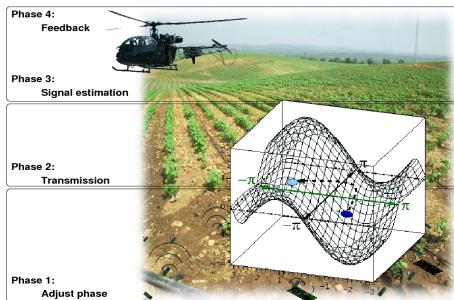

Observations

- Iterative approach similar to evolutionary random search
 - New search points are requested by altering the carrier phases
 - Fitness function implemented by receiver feedback
 - Selection of individuals based on feedback values
 - Population size and offspring population size: $\mu = \nu = 1$

Feedback based distr. adaptive beamforming

Analysis of the problem scenario

- Individual representation
 - Ordered set
 - Vector
 - Binary representation
- Fitness function
 - SNR
 - Simple distance
- Search space
 - Identical frequency
 - Distinct frequencies
- Variation operators
 - Mutation
 - Crossover

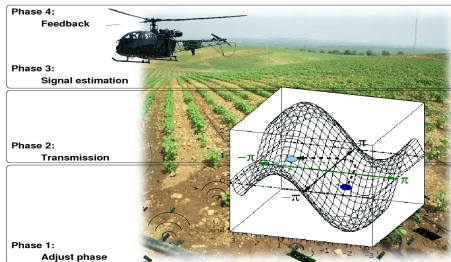

Outline

Feedback based distr. adaptive beamforming

- 1 Analysis of the problem scenario
 - Individual representation
 - Fitness function
 - Search space
 - Variation operators
- 2 Analysis of the convergence time
 - An upper bound on the synchronisation performance
 - A lower bound on the synchronisation performance
- 3 Simulation and experimental results for the basic scenario
 - Impact of distinct parameter configurations
 - Impact of environmental parameters
 - Impact of algorithmic modifications

Feedback based distr. adaptive beamforming

Analysis of the problem scenario

- Individual representation
 - Ordered set of phase and frequency pairs γ_i, f_i
 - Advantage:** Very near to the actual physical scenario
 - Disadvantage:** Similarity measures between individuals not straightforward
 - Vector $V = v_1, \dots, v_{2n}$ of phases and/or frequencies
 - Advantage:** Configurations as points in vector spaces, simple distance measure
 - Disadvantage:** Representation very problem specific/untypical
 - Binary representation of phase/frequency offsets
 - Advantage:** Various results on binary search spaces in the literature
 - Disadvantage:** Hamming distance may not represent neighbourhood similarities

Feedback based distr. adaptive beamforming

Analysis of the problem scenario

$$\mathcal{I} = \underbrace{0 \dots 1}_{\log(k) \text{ bits}} \underbrace{0 \dots 1}_{\log(\varphi) \text{ bits}} \dots \underbrace{0100 \dots 1001}_{\log(k) \text{ bits encode } k \text{ distinct possible phase offsets of node } i} \underbrace{0100 \dots 1001}_{\log(\varphi) \text{ bits encode } \varphi \text{ distinct frequency offsets of node } i} \dots \underbrace{0 \dots 1}_{\log(k) \text{ bits}} \underbrace{0 \dots 1}_{\log(\varphi) \text{ bits}}$$

Phase offset of node 1 Frequency offset for node 1 Phase offset for node i Frequency offset for node i Phase offset for node n Frequency offset for node n

- Individual representation

- Here: Binary representation of phase/frequency offsets
 - $\log(k)$ bits to represent k phase offsets
 - $\log(\varphi)$ bits to represent φ frequency offsets
 - Configurations for all nodes concatenated
- Phase and frequency offsets enumerated in ascending order
- Neighbourhood: Gray encoded bit sequence to respect neighbourhood similarities

Outline

Feedback based distr. adaptive beamforming

- 1 Analysis of the problem scenario
 - Individual representation
 - Fitness function
 - Search space
 - Variation operators
- 2 Analysis of the convergence time
 - An upper bound on the synchronisation performance
 - A lower bound on the synchronisation performance
- 3 Simulation and experimental results for the basic scenario
 - Impact of distinct parameter configurations
 - Impact of environmental parameters
 - Impact of algorithmic modifications

Feedback based distr. adaptive beamforming

Analysis of the problem scenario

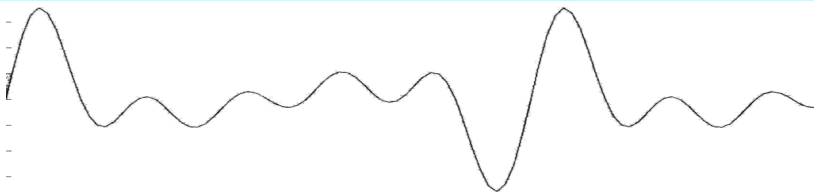

- Fitness function
 - Receiver estimates synchronisation quality of

$$\zeta_{\text{sum}} = \Re \left(m(t) e^{j2\pi f_c t} \sum_{i=1}^n \text{RSS}_i e^{j(\gamma_i + \phi_i + \psi_i)} \right)$$

- SNR
- Numeric distance
- One bit feedback?

Feedback based distr. adaptive beamforming

Analysis of the problem scenario

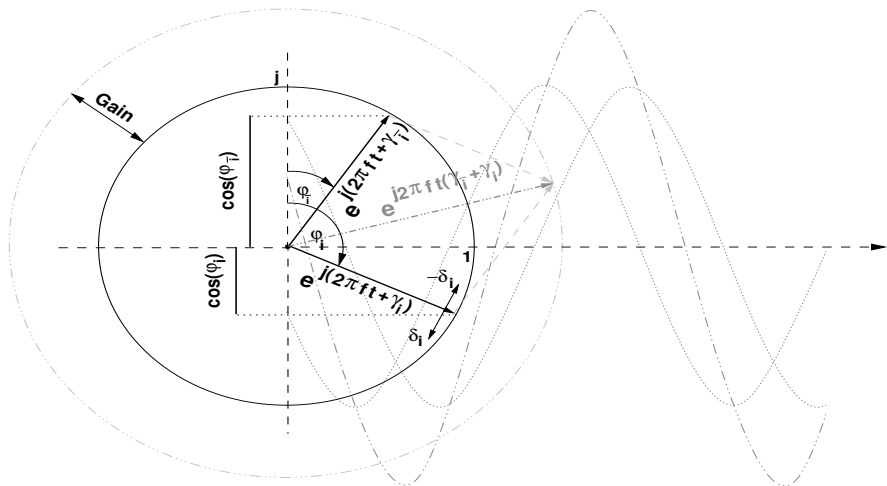

Feedback based distr. adaptive beamforming

Analysis of the problem scenario

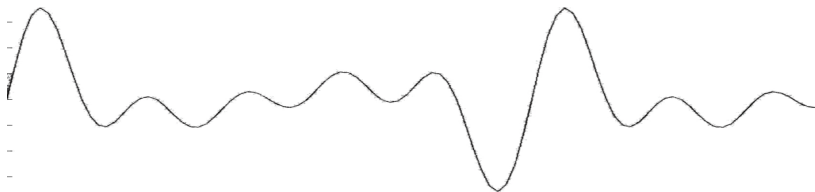

- Binary feedback
 - Minimum transmission load
 - Can be invested into higher redundancy schemes
 - Reduced information at source nodes
 - No adaptive operation
 - Less advanced optimisation schemes
 - No estimation of optimisation progress

Feedback based distr. adaptive beamforming

Analysis of the problem scenario

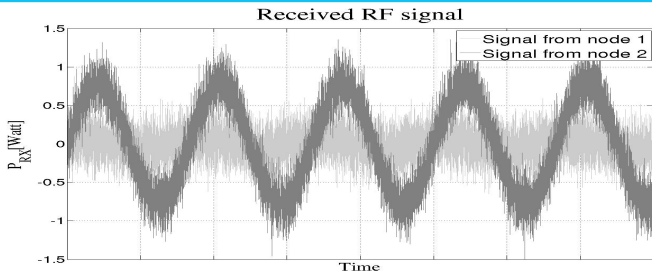

Fitness estimated by SNR :

- Calculate SNR of received sum signal
- Received signal strength above noise power
- Higher SNR interpreted as improved synchronisation quality
- Optimisation aim: Minimum required SNR

Feedback based distr. adaptive beamforming

Analysis of the problem scenario

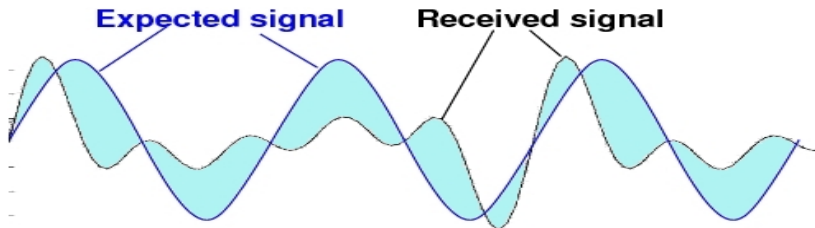

Fitness estimated by simple distance :

- Calculate surface between ζ_{opt} and ζ_{sum}
- Smaller surface \rightarrow better synchronisation quality
- Optimum signal:

$$\zeta_{\text{opt}} = \Re \left(m(t) \text{RSS}_{\text{opt}} e^{j(2\pi f_c t + \gamma_{\text{opt}} + \phi_{\text{opt}} + \psi_{\text{opt}})} \right)$$

Feedback based distr. adaptive beamforming

Analysis of the problem scenario

$$\zeta_{\text{opt}} = \Re \left(m(t) \text{RSS}_{\text{opt}} e^{j(2\pi f_c t + \gamma_{\text{opt}} + \phi_{\text{opt}} + \psi_{\text{opt}})} \right)$$

- Transmit sequence $m(t)$ (preconditioned)
- Transmit frequency f_c (preconditioned)
- Average transmit power P_{avg} (preconditioned)
- Gain G_i, G_{receiver} (preconditioned)
- Distance d to network (Estimated by RTT)
- **Number of transmitting nodes $n \rightarrow ???$**
- $\text{RSS}_{\text{opt}} = n \cdot \left(P_{\text{avg}} \cdot \left(\frac{\lambda}{2\pi \cdot d} \right)^2 \cdot G_i \cdot G_{\text{receiver}} \right)$

Feedback based distr. adaptive beamforming

Analysis of the problem scenario

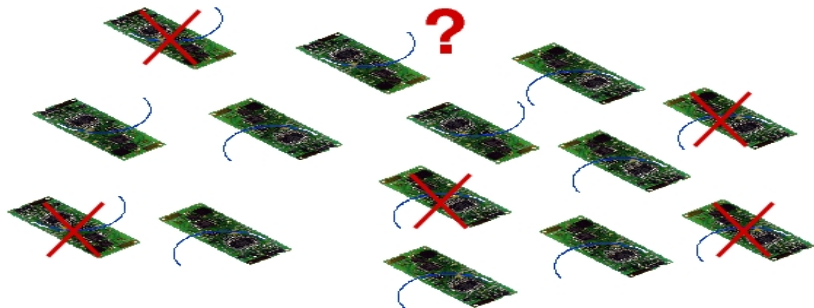

Estimate the count of transmitting nodes :

- Possible to estimate count of transmitting nodes
- From superimposed signal of simultaneously transmitting nodes¹

¹A.Krohn, Superimposed Radio Signals for Wireless Sensor Networks, PhD thesis, 2007

Feedback based distr. adaptive beamforming

Analysis of the problem scenario

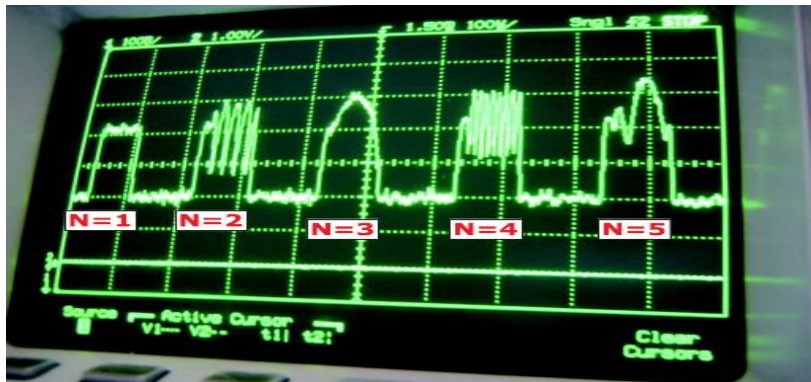

Estimate the count of transmitting nodes ²

² A.Krohn, Superimposed Radio Signals for Wireless Sensor Networks, PhD thesis, 2007

Feedback based distr. adaptive beamforming

Analysis of the problem scenario

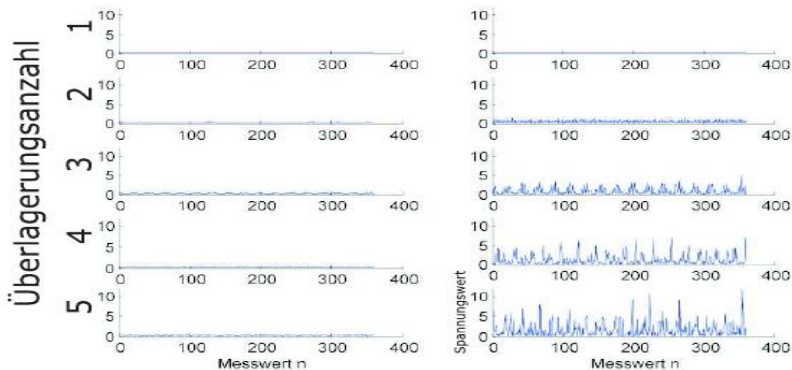

Estimate the count of transmitting nodes ³

³ A.Krohn, Superimposed Radio Signals for Wireless Sensor Networks, PhD thesis, 2007

Feedback based distr. adaptive beamforming

Analysis of the problem scenario

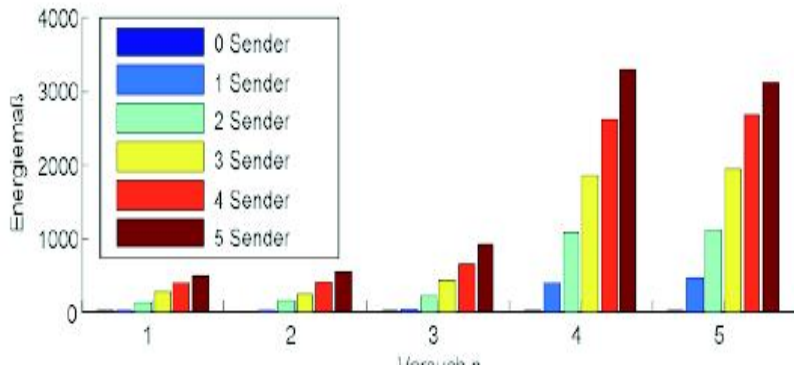

Estimate the count of transmitting nodes ⁴

⁴ A.Krohn, Superimposed Radio Signals for Wireless Sensor Networks, PhD thesis, 2007

Feedback based distr. adaptive beamforming

Analysis of the problem scenario

Geschätzte Anzahl

tatsächliche Anzahl

	0	1	2	3	4	5
0	287	0	0	0	0	0
1	0	327	3	0	0	0
2	0	0	330	0	0	0
3	0	0	32	321	14	19
4	0	0	11	69	211	124
5	0	0	0	17	39	220

Estimate the count of transmitting nodes ⁵

⁵ A.Krohn, Superimposed Radio Signals for Wireless Sensor Networks, PhD thesis, 2007

Outline

Feedback based distr. adaptive beamforming

- 1 Analysis of the problem scenario
 - Individual representation
 - Fitness function
 - Search space
 - Variation operators
- 2 Analysis of the convergence time
 - An upper bound on the synchronisation performance
 - A lower bound on the synchronisation performance
- 3 Simulation and experimental results for the basic scenario
 - Impact of distinct parameter configurations
 - Impact of environmental parameters
 - Impact of algorithmic modifications

Feedback based distr. adaptive beamforming

Analysis of the problem scenario

- Search space
 - Optimisation performance dependent on search space
 - Global or local optima?

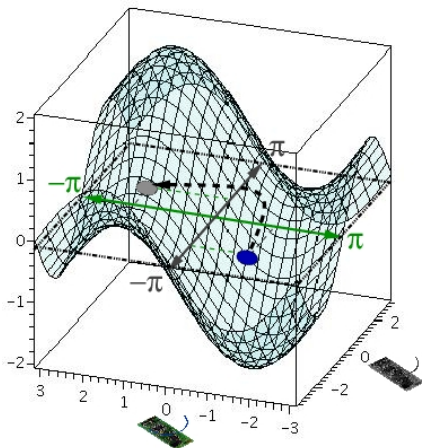

Feedback based distr. adaptive beamforming

Analysis of the problem scenario

- Search space
 - Feedback function not unimodal
 - In two global optima, carrier signals are shifted by fixed amount
 - Fitness function weak multimodal
 - Many global optima
 - No local optima

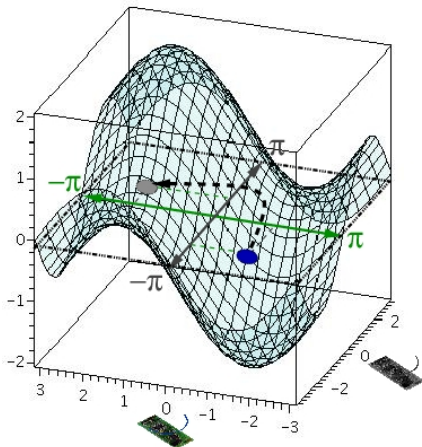

Feedback based distr. adaptive beamforming

Analysis of the problem scenario

- Search space
 - Identical transmit frequencies
 - Distinct transmit frequencies

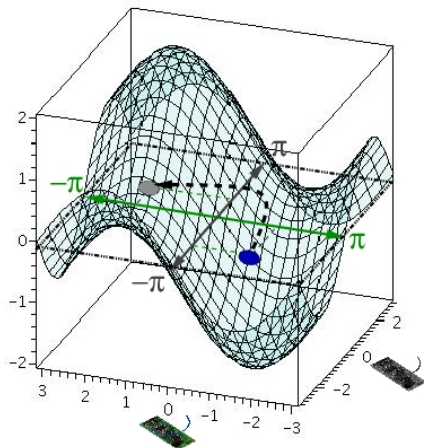

Feedback based distr. adaptive beamforming

Analysis of the problem scenario

- Identical transmit frequencies:
 $e^{j(2\pi ft + \gamma_i)}; \forall i \in \{1, \dots, n\}$
 - Local optimum: \exists search point $s_{\zeta} \neq s_{\text{opt}}$ with
 - All small phase modulations decrease fitness value
 - Smallest possible modification: Single carrier signal altered

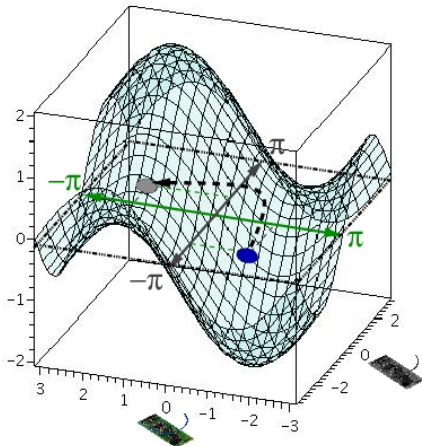

Feedback based distr. adaptive beamforming

Analysis of the problem scenario

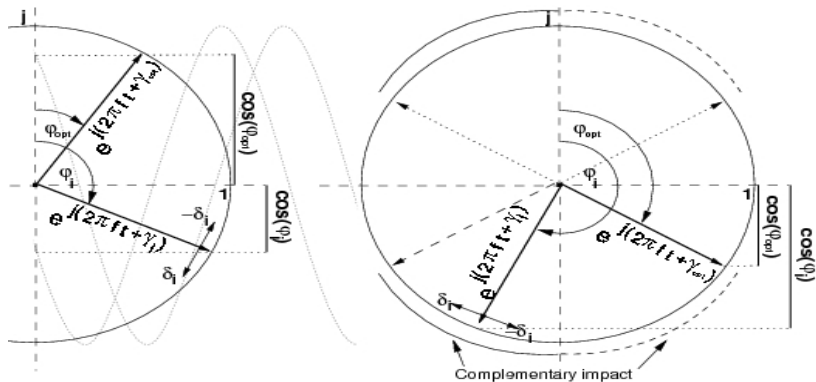

- Fitness dependent on distance $|\cos(\varphi_{opt}) - \cos(\varphi_i)|$

Feedback based distr. adaptive beamforming

Analysis of the problem scenario

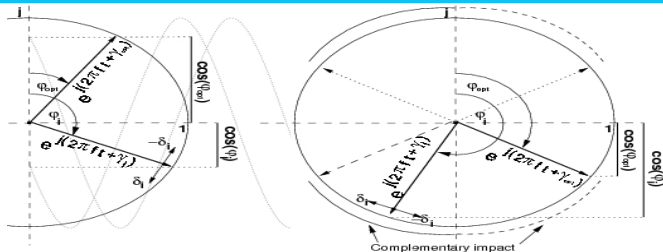

- Phase shift of $\delta_i \neq 0$ alters the fitness value
- For some t the fitness increases while for others it decreases.
- Assume $(\varphi_i + \delta_i) - \varphi_{opt} < 180^\circ$ and $\varphi_i > \varphi_{opt}$
- For $[\varphi_i > 180^\circ \wedge \varphi_{opt} < 180^\circ]$ or $[\varphi_i > 360^\circ \wedge \varphi_{opt} < 360^\circ]$
 - Contribution to \mathcal{F} zero
- Else: δ_i has either always positive or always negative impact

Feedback based distr. adaptive beamforming

Analysis of the problem scenario

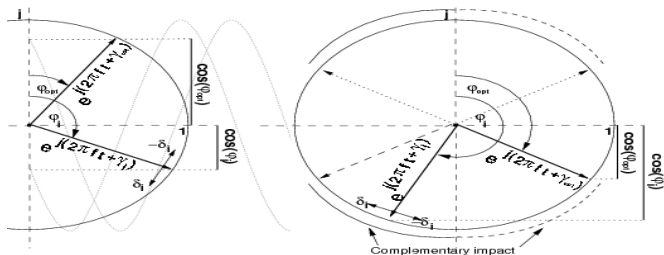

- Compared to s_{opt}
 - No configuration short of the optimum configuration $s_i = s_{opt}$ exists
 - For which distance is increased for phase offset δ_i
 - regardless of the sign of δ_i
- No local optima

Feedback based distr. adaptive beamforming

Analysis of the problem scenario

- Distinct transmit frequencies:
 $e^{j(2\pi f_i t + \gamma_i)}; \forall i \in \{1, \dots, n\}$
 - Consider phase offset between two signals:
 - Modified signal component ζ_i
 - Nearest global optimum ζ_{opt}

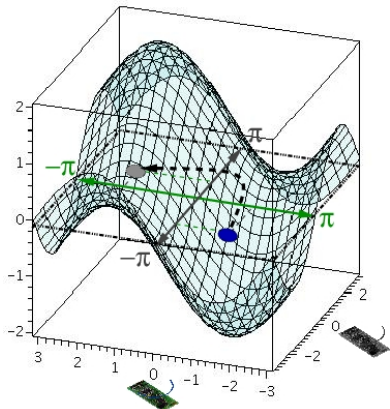

Feedback based distr. adaptive beamforming

Analysis of the problem scenario

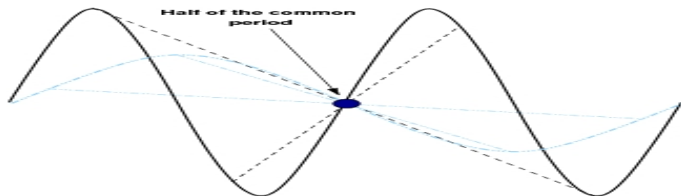

- Distinct transmit frequencies: $e^{j(2\pi f_i t + \gamma_i)}$; $\forall i \in \{1, \dots, n\}$
 - Feedback function not affected by phase modifications only
 - Periodic function: Reflection in half of common period Φ
 - For every positive contribution also negative contribution

$$\begin{aligned} & e^{j(2\pi(f_1)t \bmod \Phi + \gamma_1)} - e^{j(2\pi f t \bmod \Phi)} \\ = & - \left(e^{j(2\pi(f_1)t' \bmod \Phi + \gamma_1)} - e^{j(2\pi f t' \bmod \Phi)} \right) \end{aligned}$$

Feedback based distr. adaptive beamforming

Analysis of the problem scenario

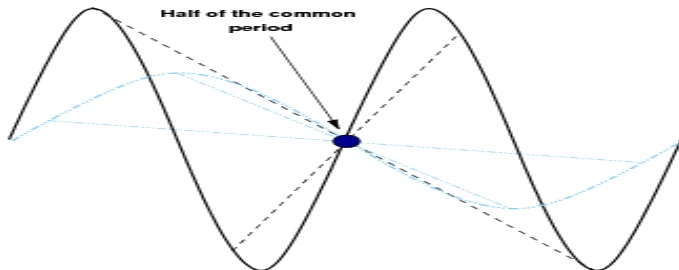

- Distinct transmit frequencies: $e^{j(2\pi f_i t + \gamma_i)}$; $\forall i \in \{1, \dots, n\}$
 - 1 signal quality is not affected by phase adaptations when frequencies are unsynchronised
 - 2 without frequency synchronisation, phase synchronisation alone is useless in order to improve the signal quality
- In both cases no local optima but several global optima

Outline

Feedback based distr. adaptive beamforming

- 1 Analysis of the problem scenario
 - Individual representation
 - Fitness function
 - Search space
 - Variation operators
- 2 Analysis of the convergence time
 - An upper bound on the synchronisation performance
 - A lower bound on the synchronisation performance
- 3 Simulation and experimental results for the basic scenario
 - Impact of distinct parameter configurations
 - Impact of environmental parameters
 - Impact of algorithmic modifications

Feedback based distr. adaptive beamforming

Analysis of the problem scenario

- Variation operators
 - Mutation
 - Crossover

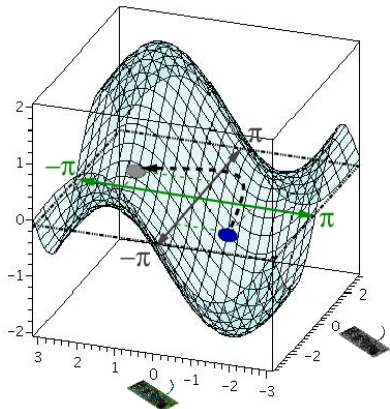

Feedback based distr. adaptive beamforming

Analysis of the problem scenario

- Variation operators – Mutation
 - Small modifications on individuals
 - Target individuals with small distance more probable
 - Phase modification of one or more carrier signals ζ_i
 - Design parameters:
 - Count of altered carrier signal components
 - Method for alteration of a single carrier

Feedback based distr. adaptive beamforming

Analysis of the problem scenario

- Variation operators – Mutation
 - Count of altered carrier signal components
 - Fixed number (how to implement in sensor network?)
 - Random number (Probability for each node)
 - Method for alteration of a single carrier
 - Neighbourhood bounds vs. Probability distribution
 - Uniform vs. Normal
 - Standard deviation σ (search neighbourhood)
 - Mean μ (search direction)

Feedback based distr. adaptive beamforming

Analysis of the problem scenario

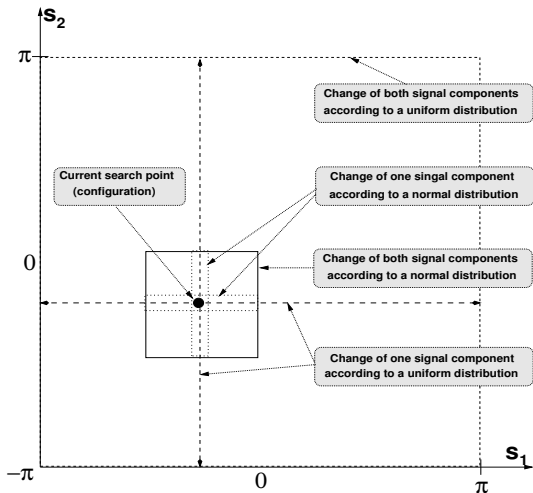

Feedback based distr. adaptive beamforming

Analysis of the problem scenario

Property	Value
Node distribution area	$30m \times 30m$
Location of the receiver	$(15m, 15m, 30m)$
Mobility	stationary nodes
Base band frequency	$f_{base} = 2.4 \text{ GHz}$
Transmission power of nodes	$P_{tx} = 1 \text{ mW}$
Gain of the transmit antenna	$G_{tx} = 0 \text{ dB}$
Gain of the receive antenna	$G_{rx} = 0 \text{ dB}$
Iterations per simulations	6000
Identical simulation runs	10
Random noise power	-103 dBm
Pathloss calculation (P_{rx})	$P_{tx} \left(\frac{\lambda}{2\pi d}\right)^2 G_{tx} G_{rx}$

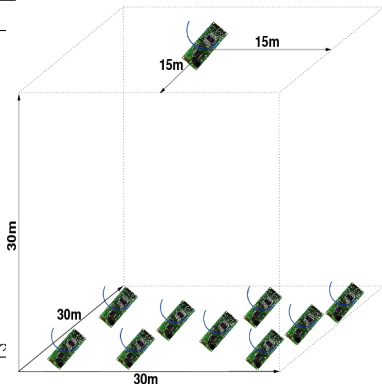

Variation operators – Mutation – example

Feedback based distr. adaptive beamforming

Analysis of the problem scenario

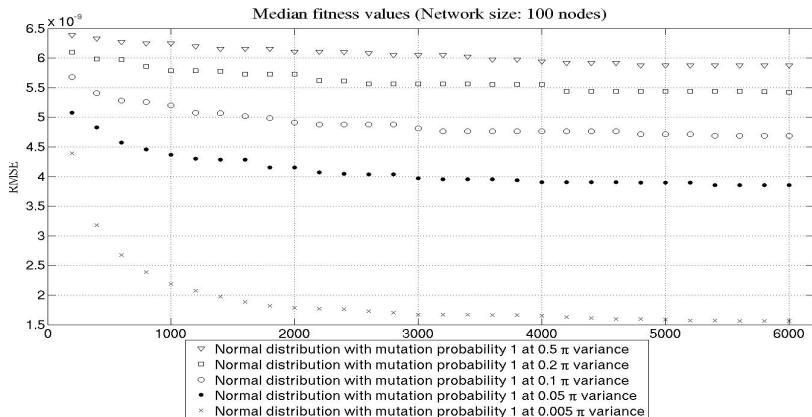

Variation operators – Mutation – example

Feedback based distr. adaptive beamforming

Analysis of the problem scenario

- Variation operators – Crossover
 - Not yet considered in the literature
 - (1 + 1)-EA straightforward as it considers one individual at a time
 - Multiple individuals possible by
 - 1 Simultaneous transmission on distinct transmit signals
 - 2 Time-shifted transmission of several individuals

Feedback based distr. adaptive beamforming

Analysis of the problem scenario

- Summary
 - 1-bit feedback based phase synchronisation always converges⁶
 - We can now come to the same result:
 - 1 No local optima in the search space
 - 2 Algorithm does never accept worse points
 - But: What is the expected time to reach an optimum?

⁶R. Mudumbai, J. Hespanha, U. Madhow, G. Barriac: Distributed transmit beamforming using feedback control. IEEE Transactions on Information Theory (In review)

Overview and Structure

- Introduction to context aware computing
- Wireless sensor networks
- Wireless communications
- Basics of probability theory
- Randomised search approaches
- Cooperative transmission schemes
- **Feedback based distributed adaptive beamforming**
 - Feedback based approaches
 - **Asymptotic bounds on the synchronisation time**
 - Alternative algorithmic approaches
 - Alternative Optimisation environments

Outline

Feedback based distr. adaptive beamforming

- 1 Analysis of the problem scenario
 - Individual representation
 - Fitness function
 - Search space
 - Variation operators
- 2 Analysis of the convergence time
 - An upper bound on the synchronisation performance
 - A lower bound on the synchronisation performance
- 3 Simulation and experimental results for the basic scenario
 - Impact of distinct parameter configurations
 - Impact of environmental parameters
 - Impact of algorithmic modifications

Feedback based distr. adaptive beamforming

Analysis of the convergence time

Assumptions :

- Network of n nodes
- Each node changes the phase of its carrier signal with probability $\frac{1}{n}$
- Carrier phase altered uniformly at random from $[0, 2\pi]$
- Feedback function $\mathcal{F} : \zeta_{\text{sum}}^* \rightarrow \mathbb{R}$ maps

$$\zeta_{\text{sum}} = \Re \left(m(t) e^{j2\pi f_c t} \sum_{i=1}^n \text{RSS}_i e^{j(\gamma_i + \phi_i + \psi_i)} \right)$$

to a real-valued fitness score.

- Possible feedback:

$$\mathcal{F}(\zeta_{\text{sum}}) = \int_{t=0}^{2\pi} |\zeta_{\text{sum}} - \zeta_{\text{opt}}|$$

Feedback based distr. adaptive beamforming

Analysis of the convergence time

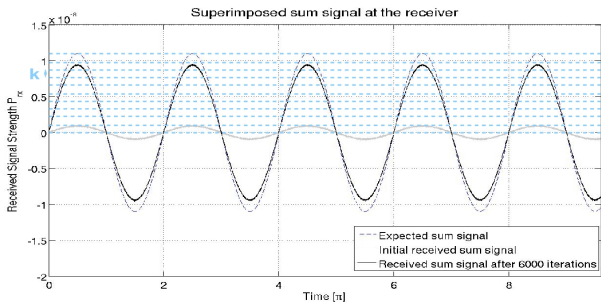

Optimisation aim :

- Achieve maximum relative phase offset of $\frac{2\pi}{k}$
- Between any two carrier signals
- For arbitrary k
- Divide phase space into k intervals of width $\frac{2\pi}{k}$

Outline

Feedback based distr. adaptive beamforming

- 1 Analysis of the problem scenario
 - Individual representation
 - Fitness function
 - Search space
 - Variation operators
- 2 Analysis of the convergence time
 - An upper bound on the synchronisation performance
 - A lower bound on the synchronisation performance
- 3 Simulation and experimental results for the basic scenario
 - Impact of distinct parameter configurations
 - Impact of environmental parameters
 - Impact of algorithmic modifications

Feedback based distr. adaptive beamforming

Analysis of the convergence time

- An upper bound on the synchronisation performance
 - Upper bound by method of fitness based partitions
 - Value of fitness function increases with number of carrier signals ζ_i that share same interval for phase offset γ_i
 - Assume, that $\kappa \in [1, k]$ is interval with most carrier phases
 - Worse fitness values are not accepted
 - Count iterations required for all carrier signals to change to interval κ
 - Note: We disregard positive possibilities to reach any other optimum
 - Possible since only upper bound is calculated

Feedback based distr. adaptive beamforming

Analysis of the convergence time

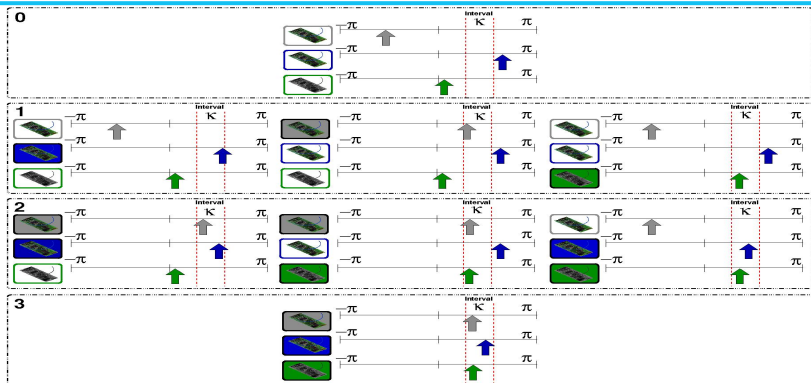

Divide values of the fitness function into k partitions :

- L_1, \dots, L_n , depending on the count of carrier signals with phase offset in κ

Feedback based distr. adaptive beamforming

Analysis of the convergence time

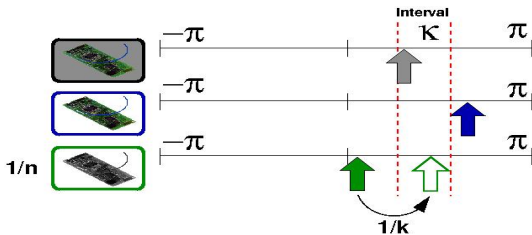

Divide values of the fitness function into k partitions :

- Probability to adapt phase to specific interval: $\frac{1}{k}$
- Probability to reach at least to next partition

$$\frac{1}{k} \cdot (n - i) \cdot \frac{1}{n}$$

Feedback based distr. adaptive beamforming

Analysis of the convergence time

- In partition i , one of

$$\binom{n-i}{1} = n-i$$

carrier signals suffice to improve the fitness value

- this happens with probability $\frac{1}{n} \cdot \frac{1}{k}$
- At least one shall be correctly altered while all other $n-1$ signals remain unchanged

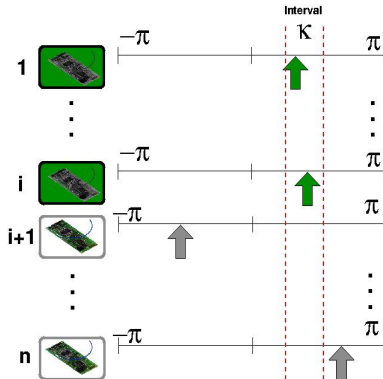

Feedback based distr. adaptive beamforming

Analysis of the convergence time

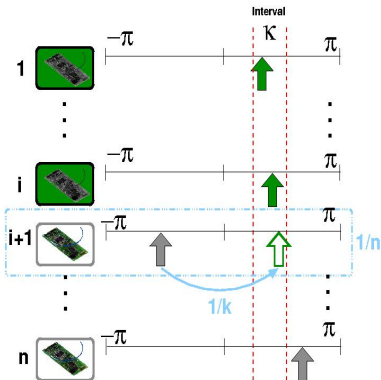

- Alter 1 carrier and keep $n - 1$ signals
- This happens with probability

$$\binom{n-i}{1} \cdot \frac{1}{n} \cdot \frac{1}{k} \cdot \left(1 - \frac{1}{n}\right)^{n-1}$$
$$= \left(\frac{n-i}{n \cdot k}\right) \cdot \left(1 - \frac{1}{n}\right)^{n-1}$$

Feedback based distr. adaptive beamforming

Analysis of the convergence time

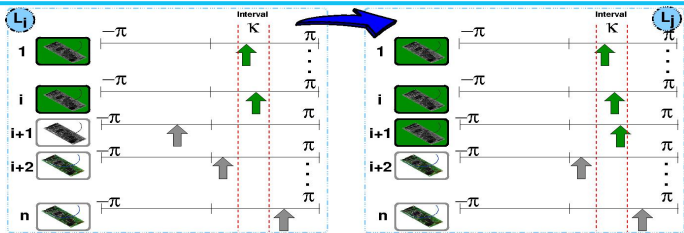

- Since

$$\left(1 - \frac{1}{n}\right)^n < \frac{1}{e} < \left(1 - \frac{1}{n}\right)^{n-1}$$

- Probability that L_i is left for partition j , $j > i$:

$$P[L_i] \geq \frac{n-i}{n \cdot e \cdot k}$$

Feedback based distr. adaptive beamforming

Analysis of the convergence time

- Expected number of iterations to change layer bounded from above by $P[L_i]^{-1}$:

$$\begin{aligned} E[T_{\mathcal{P}}] &\leq \sum_{i=0}^{n-1} \frac{e \cdot n \cdot k}{n-i} \\ &= e \cdot n \cdot k \cdot \sum_{i=1}^n \frac{1}{i} \\ &< e \cdot n \cdot k \cdot (\ln(n) + 1) \\ &= O(n \cdot k \cdot \log n) \end{aligned}$$

Outline

Feedback based distr. adaptive beamforming

- 1 Analysis of the problem scenario
 - Individual representation
 - Fitness function
 - Search space
 - Variation operators
- 2 Analysis of the convergence time
 - An upper bound on the synchronisation performance
 - A lower bound on the synchronisation performance
- 3 Simulation and experimental results for the basic scenario
 - Impact of distinct parameter configurations
 - Impact of environmental parameters
 - Impact of algorithmic modifications

Feedback based distr. adaptive beamforming

Analysis of the convergence time

$$\mathcal{I} = \underbrace{0 \dots 1}_{\log(k) \text{ bits}} \quad \underbrace{0 \dots 1}_{\log(\varphi) \text{ bits}} \quad \dots \quad \underbrace{0100 \dots 1001}_{\log(k) \text{ bits encode } k \text{ distinct possible phase offsets of node } i} \quad \underbrace{0100 \dots 1001}_{\log(\varphi) \text{ bits encode } \varphi \text{ distinct frequency offsets of node } i} \quad \dots \quad \underbrace{0 \dots 1}_{\log(k) \text{ bits}} \quad \underbrace{0 \dots 1}_{\log(\varphi) \text{ bits}}$$

Phase offset of node 1 Frequency offset for node 1 Phase offset for node i Frequency offset for node i Phase offset for node n Frequency offset for node n

- A lower bound on the synchronisation performance
 - We utilise the method of the expected progress
 - After initialisation, phases of carrier signals are identically and independently distributed.
 - Each bit in the binary representation of search point s_{ζ} has equal probability to be 1 or 0.

Feedback based distr. adaptive beamforming

Analysis of the convergence time

																Σ	
$\mathcal{I}_i =$	1	0	1	1	0	1	1	1	1	0	1	1	0	1	1	1	
$\mathcal{I}_{\text{opt}} =$	1	0	1	0	1	1	0	1	1	0	1	0	1	1	0	1	
$h(\mathcal{I}_i, \mathcal{I}_{\text{opt}}) =$	0	0	0	1	1	0	1	0	0	0	0	1	1	0	1	0	6

- Probability to start with hamming distance $h(s_{\text{opt}}, s_{\zeta}) \leq l$;
 $l \ll n \cdot \log(k)$ to global optima s_{opt} at most

$$\begin{aligned} P[h(s_{\text{opt}}, s_{\zeta}) \leq l] &= \sum_{i=0}^l \binom{n \cdot \log(k)}{n \cdot \log(k) - i} \cdot \frac{k}{2^{n \cdot \log(k) - i}} \\ &\leq \frac{(n \cdot \log(k))^{l+2}}{2^{n \cdot \log(k) - l}} \end{aligned}$$

Feedback based distr. adaptive beamforming

Analysis of the convergence time

																Σ	
$\mathcal{I}_i =$	1	0	1	1	0	1	1	1	1	0	1	1	0	1	1	1	
$\mathcal{I}_{\text{opt}} =$	1	0	1	0	1	1	0	1	1	0	1	0	1	1	0	1	
$h(\mathcal{I}_i, \mathcal{I}_{\text{opt}}) =$	0	0	0	1	1	0	1	0	0	0	0	1	1	0	1	0	6

$$P[h(s_{\text{opt}}, s_{\zeta}) \leq l] \leq \frac{(n \cdot \log(k))^{l+2}}{2^{n \cdot \log(k) - l}}$$

- Count of configurations with i bit errors to s_{opt} :

$$\binom{n \cdot \log(k)}{n \cdot \log(k) - i}$$

- Probability for all these bits to be correct: $\frac{1}{2^{n \cdot \log(k) - i}}$
- Count of global optima: k

Feedback based distr. adaptive beamforming

Analysis of the convergence time

$$\mathcal{I} = \underbrace{0 \dots 1}_{\log(k) \text{ bits}} \underbrace{0 \dots 1}_{\log(\varphi) \text{ bits}} \dots \underbrace{0100 \dots 1001}_{\log(k) \text{ bits encode } k \text{ distinct possible phase offsets of node } i} \underbrace{0100 \dots 1001}_{\log(\varphi) \text{ bits encode } \varphi \text{ distinct frequency offsets of node } i} \dots \underbrace{0 \dots 1}_{\log(k) \text{ bits}} \underbrace{0 \dots 1}_{\log(\varphi) \text{ bits}}$$

$$\begin{aligned}
 P[h(s_{\text{opt}}, s_{\zeta}) \leq l] &= \sum_{i=0}^l \binom{n \cdot \log(k)}{n \cdot \log(k) - i} \cdot \frac{k}{2^{n \cdot \log(k) - i}} \\
 &\leq \frac{(n \cdot \log(k))^{l+2}}{2^{n \cdot \log(k) - l}}
 \end{aligned}$$

- This means that with high probability (w.h.p.) the hamming distance to the nearest global optimum is at least l .

Feedback based distr. adaptive beamforming

Analysis of the convergence time

- Use method of expected progress to calculate lower bound:
- (s_ζ, t) denotes that s_ζ is achieved after t iterations
- Assume Progress measure $\Lambda : \mathbb{B}^{n \cdot \log(k)} \rightarrow \mathbb{R}_0^+$
- $\Lambda(s_\zeta, t) < \Delta$: Global optimum not found in first t iterations
- For every $t \in \mathbb{N}$ we have

$$\begin{aligned} E[T_{\mathcal{P}}] &\geq t \cdot P[T_{\mathcal{P}} > t] \\ &= t \cdot P[\Lambda(s_\zeta, t) < \Delta] \\ &= t \cdot (1 - P[\Lambda(s_\zeta, t) \geq \Delta]) \end{aligned}$$

Feedback based distr. adaptive beamforming

Analysis of the convergence time

$$E[T_{\mathcal{P}}] \geq t \cdot (1 - P[\Lambda(s_{\zeta}, t) \geq \Delta])$$

- With the help of the Markov-inequality we obtain

$$P[\Lambda(s_{\zeta}, t) \geq \Delta] \leq \frac{E[\Lambda(s_{\zeta}, t)]}{\Delta}$$

- and therefore

$$E[T_{\mathcal{P}}] \geq t \cdot \left(1 - \frac{E[\Lambda(s_{\zeta}, t)]}{\Delta}\right)$$

- Obtain lower bound by providing expected progress after t iterations

Feedback based distr. adaptive beamforming

Analysis of the convergence time

- Probability for l bits to correctly flip at most

$$\left(1 - \frac{1}{n \cdot \log(k)}\right)^{n \cdot \log(k) - l} \cdot \left(\frac{1}{n \cdot \log(k)}\right)^l \leq \frac{1}{(n \cdot \log(k))^l}$$

- Probability that no correct but remaining l bits flip:

$$\left(1 - \frac{1}{n \cdot \log(k)}\right)^{n \cdot \log(k) - l}$$

- l bits mutate with probability $\left(\frac{1}{n \cdot \log(k)}\right)^l$

- Expected progress in one iteration:

$$E[\Lambda(s_{\zeta}, t), \Lambda(s_{\zeta'}, t + 1)] \leq \sum_{i=1}^l \frac{i}{(n \cdot \log(k))^i} < \frac{2}{n \cdot \log(k)}$$

- Expected progress in t iterations: $\leq \frac{2t}{n \cdot \log(k)}$

Feedback based distr. adaptive beamforming

Analysis of the convergence time

- Choose $t = \frac{n \cdot \log(k) \cdot \Delta}{4} - 1$
- Double of expected progress still smaller than Δ .
- With Markov inequality: Progress not achieved with prob. $\frac{1}{2}$.
- Expected optimisation time bounded from below by

$$\begin{aligned} E[T_{\mathcal{P}}] &\geq t \cdot \left(1 - \frac{E[\Lambda(s_{\zeta}, t)]}{\Delta}\right) \\ &\geq \frac{n \cdot \log(k) \cdot \Delta}{4} \cdot \left(1 - \frac{\frac{2 \cdot n \cdot \log(k)}{4 \cdot n \cdot \log(k)} \cdot \Delta}{\Delta}\right) \\ &= \Omega(n \cdot \log(k) \cdot \Delta) \end{aligned}$$

- With $\Delta = k \cdot \frac{\log(n)}{\log(k)}$: Same order as upper bound:

$$E[T_{\mathcal{P}}] = \Theta(n \cdot k \cdot \log(n))$$

Outline

Feedback based distr. adaptive beamforming

- 1 Analysis of the problem scenario
 - Individual representation
 - Fitness function
 - Search space
 - Variation operators
- 2 Analysis of the convergence time
 - An upper bound on the synchronisation performance
 - A lower bound on the synchronisation performance
- 3 Simulation and experimental results for the basic scenario
 - Impact of distinct parameter configurations
 - Impact of environmental parameters
 - Impact of algorithmic modifications

Overview and Structure

- Introduction to context aware computing
- Wireless sensor networks
- Wireless communications
- Basics of probability theory
- Randomised search approaches
- Cooperative transmission schemes
- **Feedback based distributed adaptive beamforming**
 - Feedback based approaches
 - Asymptotic bounds on the synchronisation time
 - **Simulation and experimental results**
 - Alternative algorithmic approaches
 - Alternative Optimisation environments

Outline

Feedback based distr. adaptive beamforming

- 1 Analysis of the problem scenario
 - Individual representation
 - Fitness function
 - Search space
 - Variation operators
- 2 Analysis of the convergence time
 - An upper bound on the synchronisation performance
 - A lower bound on the synchronisation performance
- 3 Simulation and experimental results for the basic scenario
 - Impact of distinct parameter configurations
 - Impact of environmental parameters
 - Impact of algorithmic modifications

Feedback based distr. adaptive beamforming

Simulation and experimental results

Property	Value
Node distribution area	$30m \times 30m$
Location of the receiver	$(15m, 15m, 30m)$
Mobility	stationary nodes
Base band frequency	$f_{base} = 2.4 \text{ GHz}$
Transmission power of nodes	$P_{tx} = 1 \text{ mW}$
Gain of the transmit antenna	$G_{tx} = 0 \text{ dB}$
Gain of the receive antenna	$G_{rx} = 0 \text{ dB}$
Iterations per simulations	6000
Identical simulation runs	10
Random noise power	-103 dBm
Pathloss calculation (P_{rx})	$P_{tx} \left(\frac{\lambda}{2\pi d}\right)^2 G_{tx} G_r$

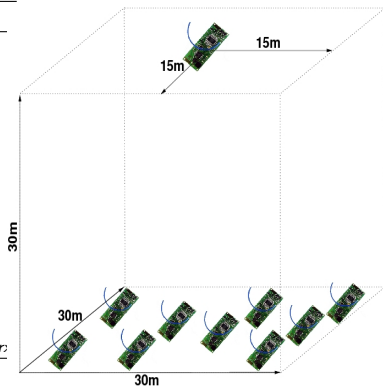

Feedback based distr. adaptive beamforming

Simulation and experimental results

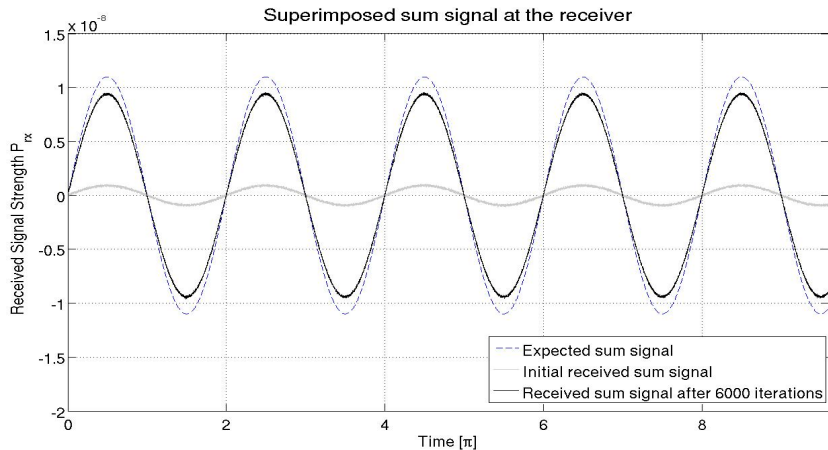

Feedback based distr. adaptive beamforming

Simulation and experimental results

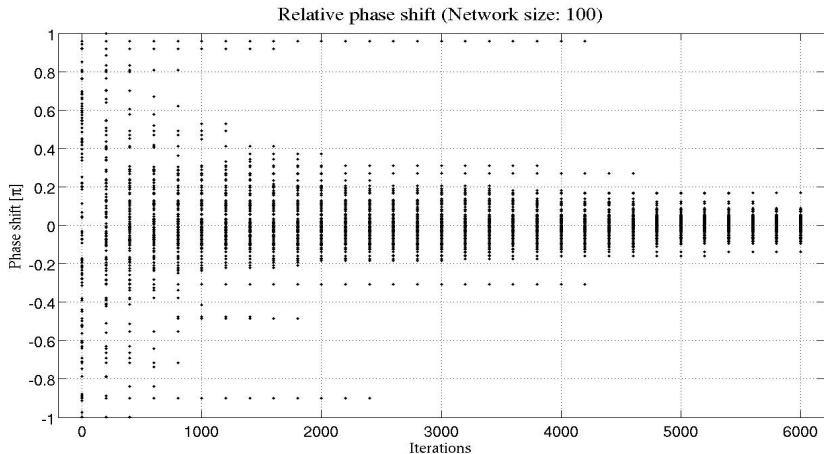

Feedback based distr. adaptive beamforming

Simulation and experimental results

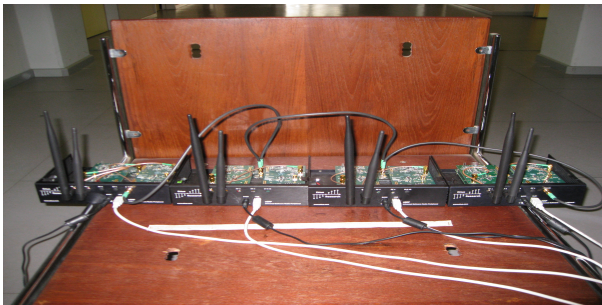

- Experiment with USRP software radios
 - Software: GNURadio
 - Processing, analysis and visualisation of RF signals
 - Graphical assembly of Signal flow graph

Feedback based distr. adaptive beamforming

Simulation and experimental results

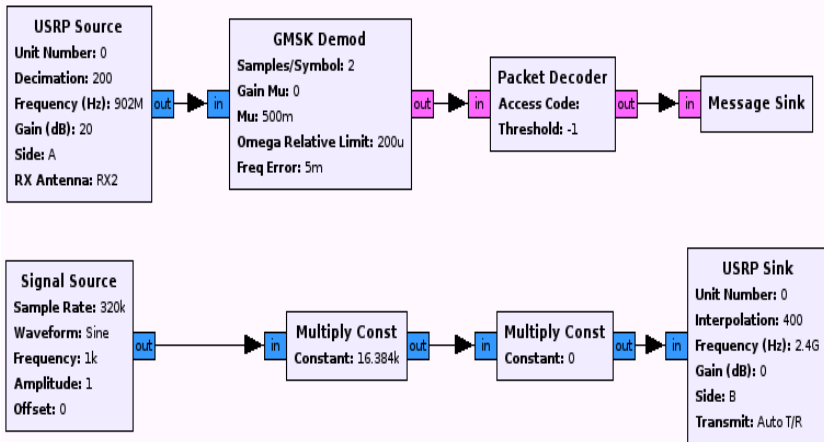

Feedback based distr. adaptive beamforming

Simulation and experimental results

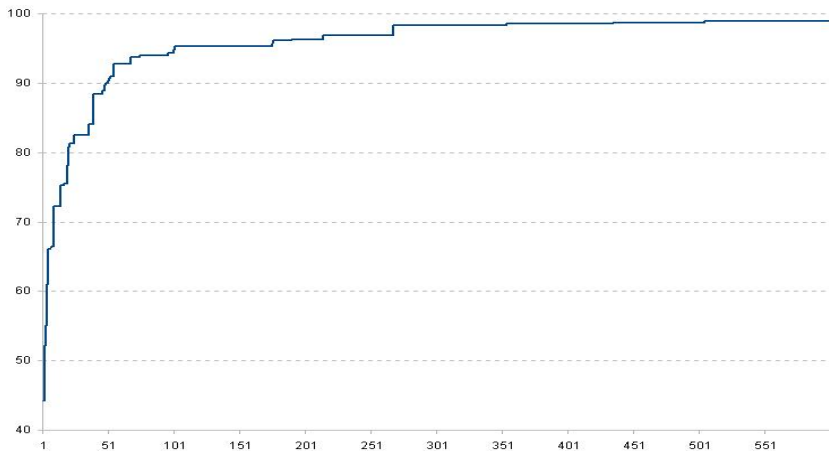

Feedback based distr. adaptive beamforming

Simulation and experimental results

	Experiment 1	Experiment 2
Sender	4	3
Mobility	stationary	stationary
Distance to receiver [m]	≈ 0.75	≈ 4
Separation of TX antennas [m]	≈ 0.21	≈ 0.3
Transmit RF Frequency [MHz]	$f_{TX} = 2400$	$f_{TX} = 27$
Receive RF Frequency [MHz]	$f_{RX} = 902$	$f_{RX} = 902$
Gain of receive antenna [dBi]	$G_{RX} = 3$	$G_{RX} = 3$
Gain of transmit antenna [dBi]	$G_{TX} = 3$	$G_{TX} = 1.5$
Iterations per experiment	500	200
Identical experiments	14	10
Median gain (P_{RX}) [dB]	2.19	3.72

Feedback based distr. adaptive beamforming

Simulation and experimental results

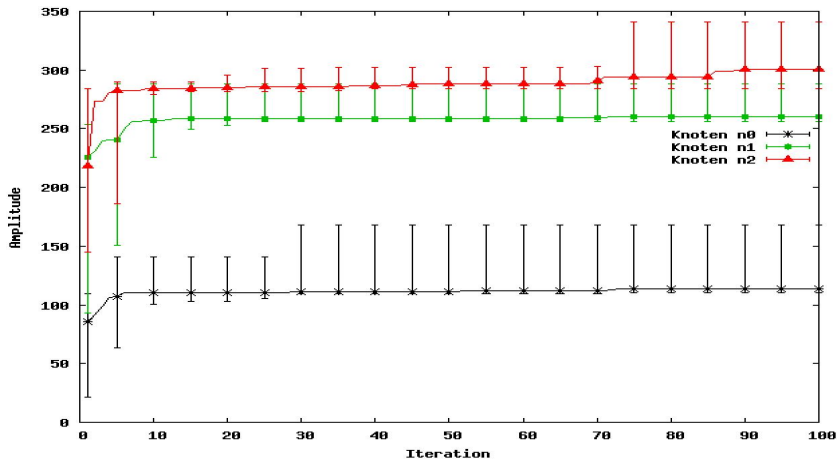

Outline

Feedback based distr. adaptive beamforming

- 1 Analysis of the problem scenario
 - Individual representation
 - Fitness function
 - Search space
 - Variation operators
- 2 Analysis of the convergence time
 - An upper bound on the synchronisation performance
 - A lower bound on the synchronisation performance
- 3 Simulation and experimental results for the basic scenario
 - Impact of distinct parameter configurations
 - Impact of environmental parameters
 - Impact of algorithmic modifications

Feedback based distr. adaptive beamforming

Simulation and experimental results

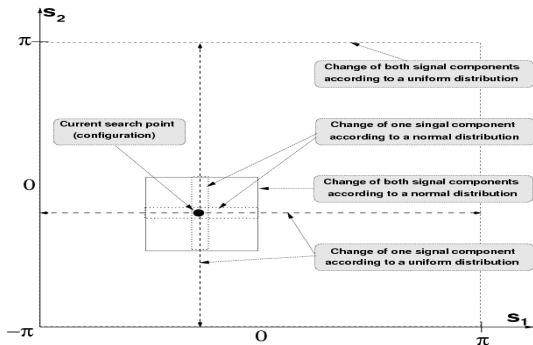

- Impact of distinct optimisation parameters
 - Uniformly distributed phase offset
 - distributed phase offset
 - Probability for individual nodes to alter their phase

Feedback based distr. adaptive beamforming

Simulation and experimental results

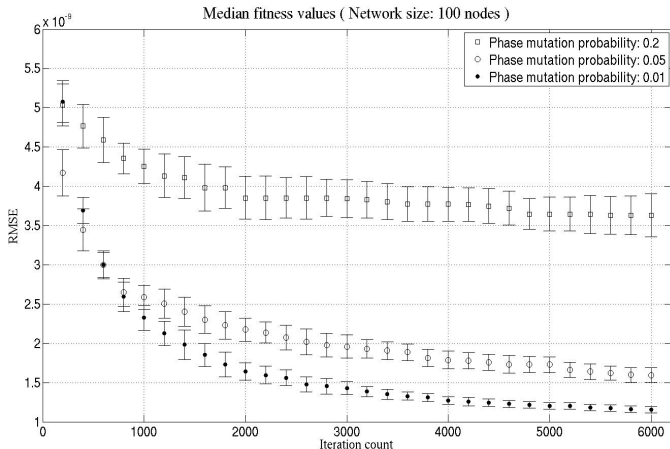

- Uniformly distributed phase offset – Impact of the mutation probability

Feedback based distr. adaptive beamforming

Simulation and experimental results

- Uniformly distributed phase offset – Impact of the mutation probability
 - Small mutation probability beneficial
 - Small steps in the search space
 - Higher mutation probability leads to better performance at the start of the synchronisation
 - Best: One node changes phase offset on average in one iteration

Feedback based distr. adaptive beamforming

Simulation and experimental results

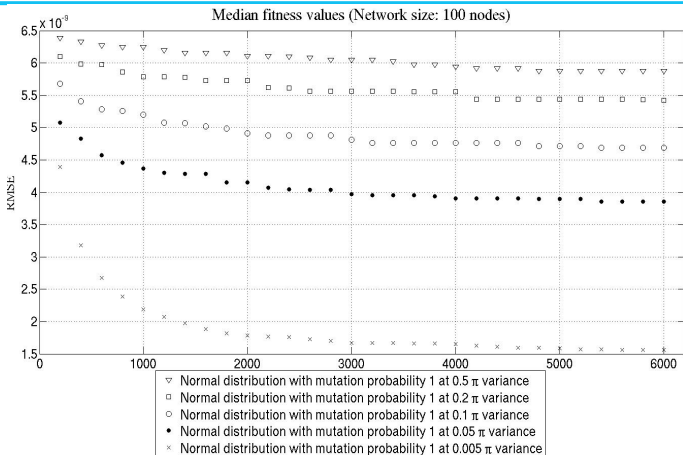

- Normal distributed phase offset – Impact of the mutation variance

Feedback based distr. adaptive beamforming

Simulation and experimental results

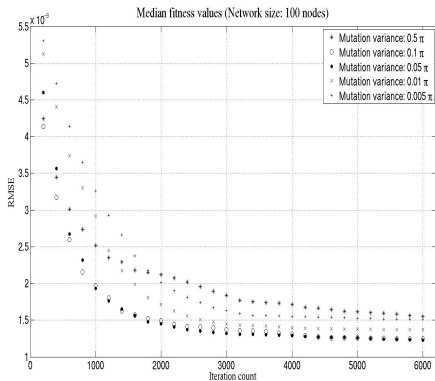
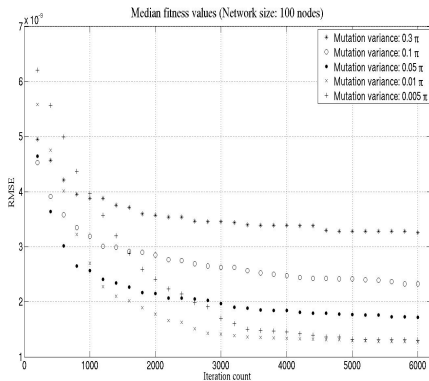

- Normal distributed phase offset – Impact of the mutation variance
 - Optimisation performance degenerates when variance too small

Feedback based distr. adaptive beamforming

Simulation and experimental results

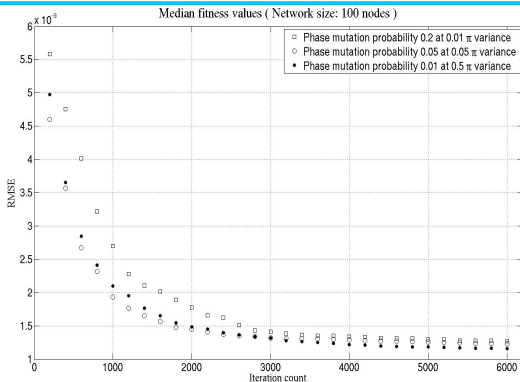

- Normal distributed phase offset – Impact of the mutation variance
 - Optimum variance dependent on mutation probability
 - Small mutation probabilities generally beneficial

Feedback based distr. adaptive beamforming

Simulation and experimental results

- Normal distributed phase offset – Impact of the mutation variance
 - Small variance beneficial
 - Small steps in the search space
 - Higher variance leads to better performance at the start of the synchronisation
 - But: When variance too small, optimisation performance degenerates
 - Best variance dependent on mutation probability
- Performance of best configuration similar for uniform and normal distributed phase alteration process.

Feedback based distr. adaptive beamforming

Simulation and experimental results

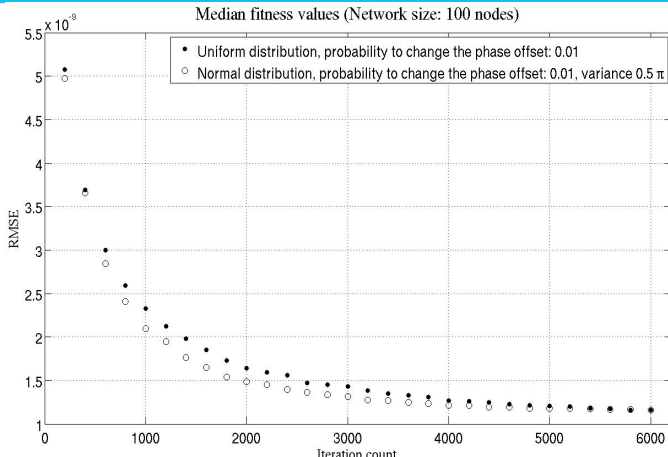

- Performance of best configuration similar for uniform and normal distributed phase alteration process.

Outline

Feedback based distr. adaptive beamforming

- 1 Analysis of the problem scenario
 - Individual representation
 - Fitness function
 - Search space
 - Variation operators
- 2 Analysis of the convergence time
 - An upper bound on the synchronisation performance
 - A lower bound on the synchronisation performance
- 3 Simulation and experimental results for the basic scenario
 - Impact of distinct parameter configurations
 - Impact of environmental parameters
 - Impact of algorithmic modifications

Feedback based distr. adaptive beamforming

Simulation and experimental results

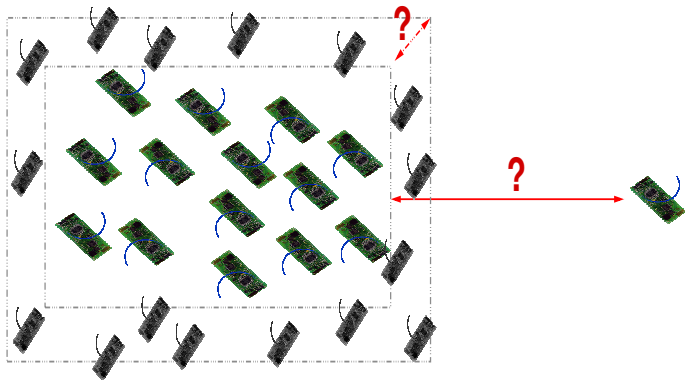

- Impact of environmental parameters
 - Network size
 - Distance between receiver and network

Feedback based distr. adaptive beamforming

Simulation and experimental results

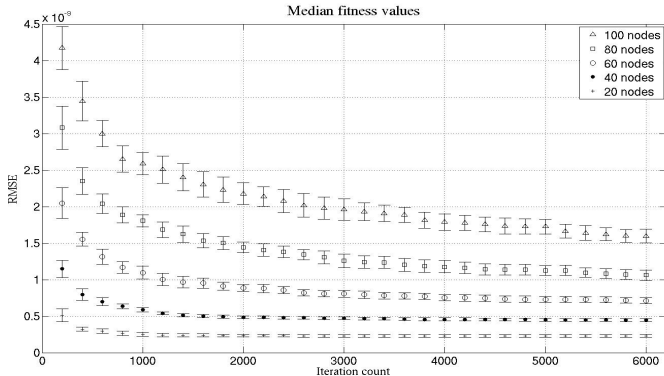

- Impact of the network size

Feedback based distr. adaptive beamforming

Simulation and experimental results

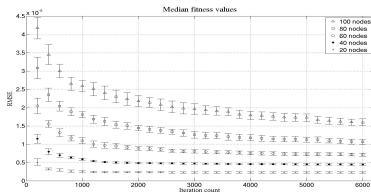

- Impact of the network size
 - Smaller network size results in faster synchronisation performance
 - RMSE decreases as maximum distance between received and optimum signal decreased
 - Optimum level reached earlier for smaller network sizes

Feedback based distr. adaptive beamforming

Simulation and experimental results

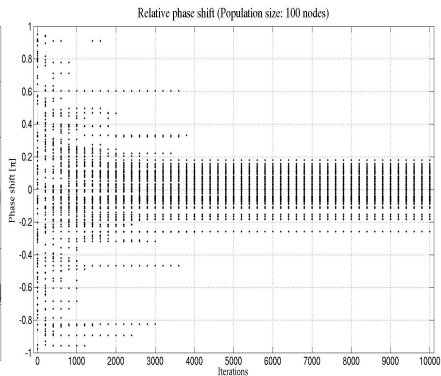
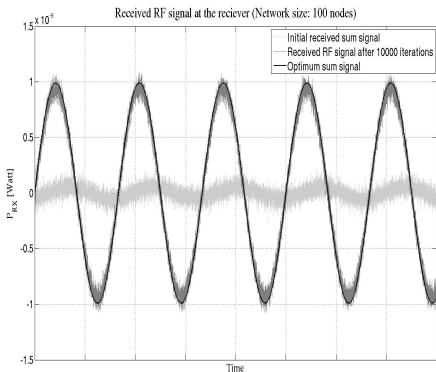

- Distance between receiver and network – 100m

Feedback based distr. adaptive beamforming

Simulation and experimental results

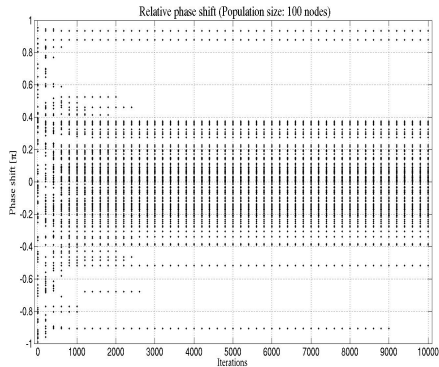
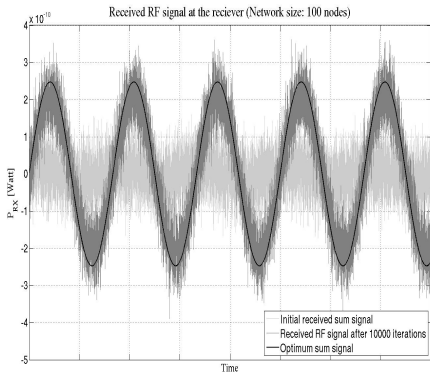

- Distance between receiver and network – 200m

Feedback based distr. adaptive beamforming

Simulation and experimental results

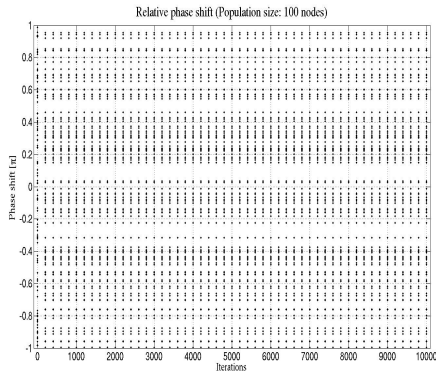
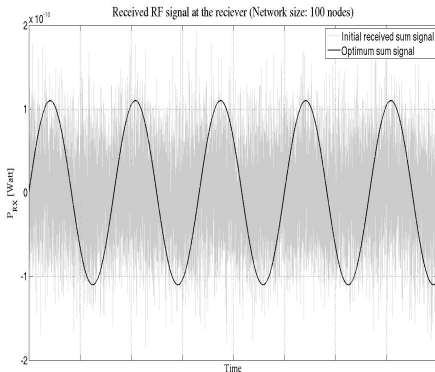

- Distance between receiver and network – 300m

Feedback based distr. adaptive beamforming

Simulation and experimental results

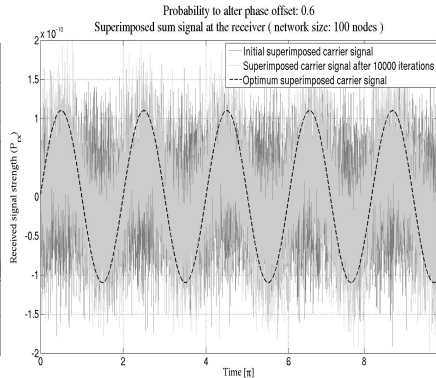
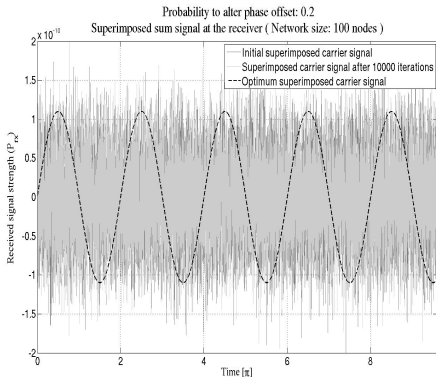

- Distance between receiver and network – 300m
 - Improved synchronisation quality with increased mutation probability

Feedback based distr. adaptive beamforming

Simulation and experimental results

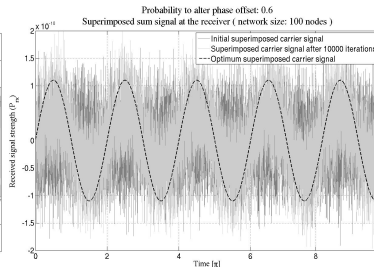
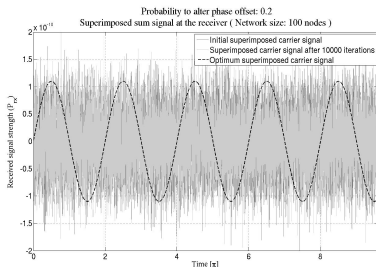

- Impact of the transmission distance
 - Synchronisation performance and quality decrease with increasing distance
 - With higher relative noise figure, an increased mutation probability is beneficial

Outline

Feedback based distr. adaptive beamforming

- 1 Analysis of the problem scenario
 - Individual representation
 - Fitness function
 - Search space
 - Variation operators
- 2 Analysis of the convergence time
 - An upper bound on the synchronisation performance
 - A lower bound on the synchronisation performance
- 3 Simulation and experimental results for the basic scenario
 - Impact of distinct parameter configurations
 - Impact of environmental parameters
 - Impact of algorithmic modifications

Feedback based distr. adaptive beamforming

Simulation and experimental results

- Impact of algorithmic modifications
 - Reelection of unsuccessful nodes
 - Reelection of successful nodes
 - Preconfigured nodes

Feedback based distr. adaptive beamforming

Simulation and experimental results

- Reelection of unsuccessful nodes⁷
 - Information is lost when nodes discard carrier phases due to worse feedback
 - On average: Fitness decreases on every second iteration
 - Performance improvement of factor 2

⁷ J.A. Bucklew, W.A. Sethares: Convergence of a class of decentralised beamforming algorithms. IEEE Transactions on Signal Processing 56(6) (2008)

Feedback based distr. adaptive beamforming

Simulation and experimental results

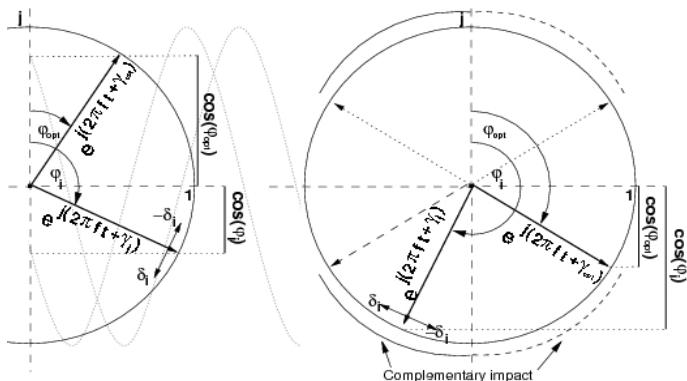

- Relection of unsuccessful nodes⁸

⁸ J.A. Bucklew, W.A. Sethares: Convergence of a class of decentralised beamforming algorithms. IEEE Transactions on Signal Processing 56(6) (2008)

Feedback based distr. adaptive beamforming

Simulation and experimental results

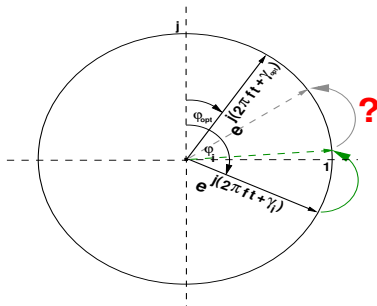

- Relection of successful nodes
 - Random search
 - Whp: When node successful, fitness still not optimal
 - Possible implementations:
 - Utilise same node again
 - Apply same phase offset again

Feedback based distr. adaptive beamforming

Simulation and experimental results

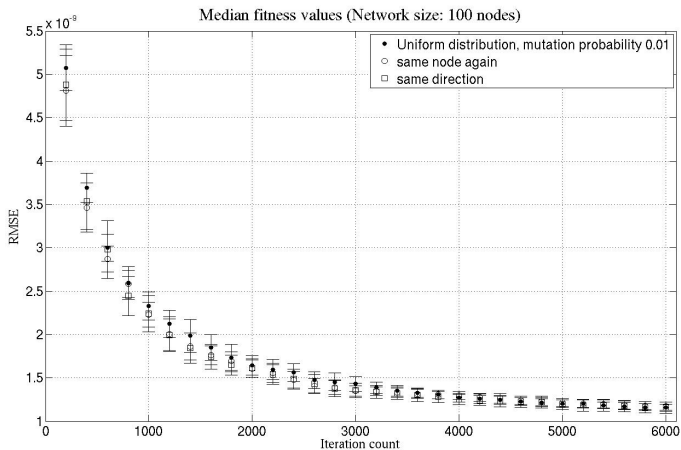

- Relection of successful nodes

Feedback based distr. adaptive beamforming

Simulation and experimental results

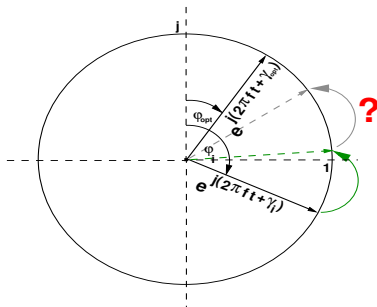

- Reelection of successful nodes
 - For both implementations performance improvement
 - Early in the synchronisation
 - Only small improvements

Feedback based distr. adaptive beamforming

Simulation and experimental results

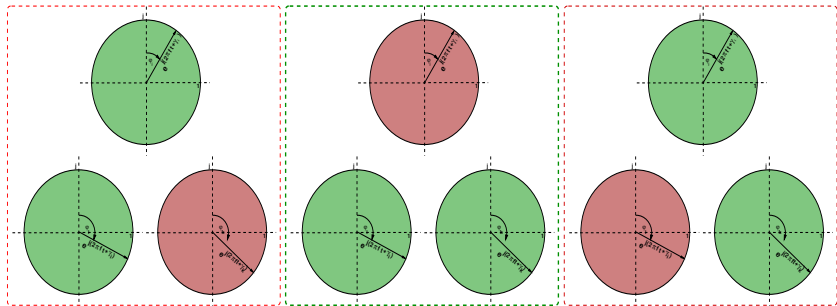

- Preconfigured nodes
 - When only a subset of nodes is required to reach the receiver
 - Choose those nodes that are best preconfigured
 - Start with better preconfigured nodes

Scenario analysis and algorithmic improvement

Impact of the node choice

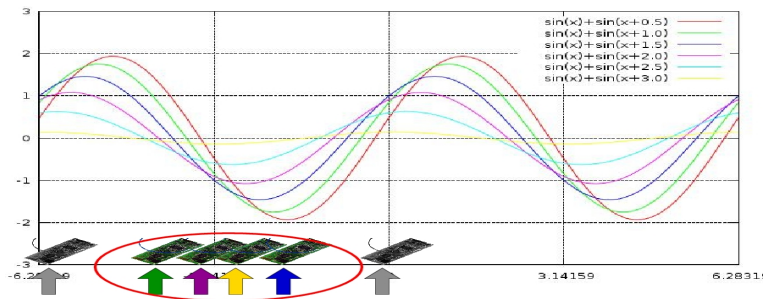

- Synchronisation performance dependent on number of participating nodes
- When not all nodes are required, utilise only a subset of nodes
- Optimum: Select subset of nodes that is best pre-synchronised

Feedback based distr. adaptive beamforming

Simulation and experimental results

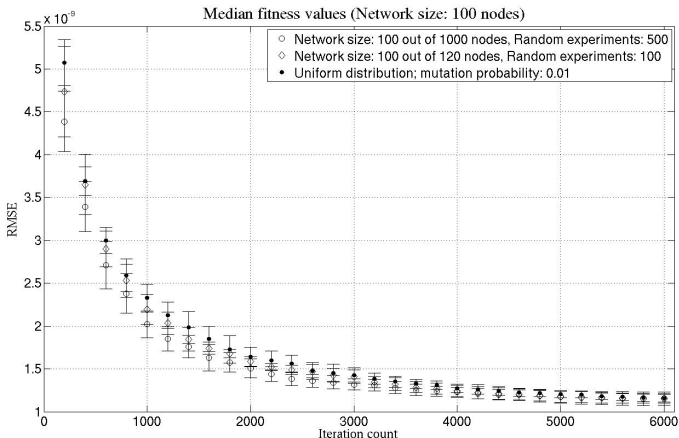

- Preconfigured nodes

Feedback based distr. adaptive beamforming

Simulation and experimental results

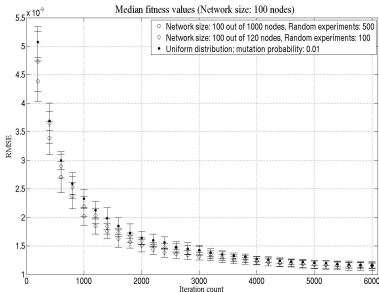

- Preconfigured nodes
 - Performance improved in all cases
 - Also when only 20% of all nodes are disregarded

Overview and Structure

- Introduction to context aware computing
- Wireless sensor networks
- Wireless communications
- Basics of probability theory
- Randomised search approaches
- Cooperative transmission schemes
- Distributed adaptive beamforming
 - Feedback based approaches
 - Asymptotic bounds on the synchronisation time
 - Alternative algorithmic approaches
 - Alternative Optimisation environments