



Technische
Universität
Braunschweig

Institut für Betriebssysteme
und Rechnerverbund



Recent Topics in Computer Networking

Wireless Sensor Networks – Introduction and Applications

Lars Wolf, Felix Büsching, IBR-CM
Winter Term 2012/13

Outline

- Motivation
- Terms
- Design considerations
- Challenges
- WSN Applications

WSN Motivation

Various visionary concepts like “Ubiquitous Computing”
(also others influenced the field)



Mark Weiser
(1952-1999)

1988: Notion „Ubiquitous Computing“

Introduced and defined by Mark Weiser, XeroxParc

- Ubiquitous „everywhere“
- Ubiquitous: economically, in arbitrary amount available

1991 „The Computer for the 21st Century“

Article in Scientific American

Vision: Computers become so much of our daily live that we do not take notice of them any longer

“Ubiquitous Computing enhances computer use by making computers **available throughout** the physical environment, while making them **effectively invisible** to the user”



Ubiquitous computing

Vision of M. Weiser, XeroxParc

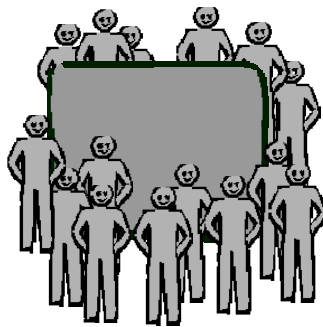

Mainframe Comp.

Humans share a rare resource
Usage explicit, use well prepared
User: Experts

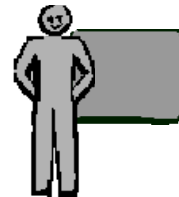

Personal Comp.

Personal
Direct usage
User: Everybody, supported by experts

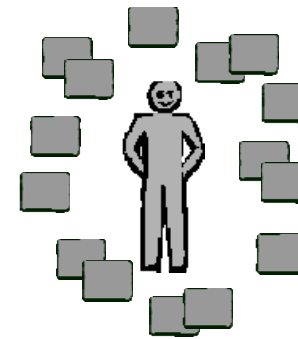

Ubiquitous Comp.

Ubiquitous
Implicit usage
User: Everybody



Ubiquitous computing

The most profound technologies are those that disappear:

(according to Weiser et al.)

- E.g., Writing: does not require active attention, but the information to be conveyed is ready for use at a glance (Periphery / calm technology)
- We should not be required to live in computer's world (OS, virtual reality), computers should become invisible and ubiquitous (disappear in background) in our physical world
- Already computers in light switches, thermostats, stereos and ovens help to activate the world

Ubiquitous computing

Disappearing computing ...

For such, base technologies are crucial, e.g.,

- “Sufficiently” powerful processors & storage
- Wireless communication
- Sensors
- Actuators

Not for all such “applications” & “scenarios”, humans must be involved directly

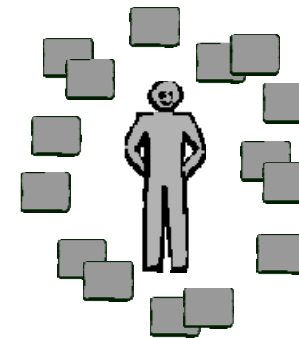

WSN Motivation

For many applications & scenarios where **interaction with environment** is taking place:

- Direct interaction with humans is not necessary or not possible
 - E.g., monitoring industrial processes
 - Humans should be involved in specific situations only
 - E.g., in case of an emergency
 - Or if collected measurement data should be studied, interpreted etc.
- potentially autonomous operation unless help by human is needed

WSN Motivation

Needs for applications & scenarios interested in
interaction with environment:

- Sensing in environment
- Computing in environment to process data
- Communication to transport data
- Networking to build up larger distributed systems
- Actuation to influence environment

→ *Wireless sensor networks (WSN)*

- Or: *Wireless sensor & actuator networks (WSAN)*

WSN Motivation

Also a reason:

Technology advances make it possible ...

... allow for smaller computerized devices with

- processors, sensors, communication, ...

CMOS miniaturization

Micro-sensors (MEMS, materials, circuits)

- acceleration, vibration, gyroscope, tilt, magnetic, heat, motion, pressure, temp, light, moisture, humidity, barometric
- chemical (CO, CO₂, radon), biological, microradar, ...
- actuators too (mirrors, motors, smart surfaces, micro-robots)

Communication

- short range, low bit-rate, CMOS radios

Power

- Batteries, fuel cells
- solar, vibration, flow



Sensor & sensor network

Different terms can be used, also depending on discipline

- Sensor: device which allows “sensing” of the environment (delivers some relatively simple output)
- Sensor system: capable to do some processing
- In WSN field (in computer science & engineering): “sensor / sensor node” typically includes already some processing
 - Often no strict difference between sensor, sensor system, sensor node

Sensor & sensor network

Sensor network consists of some ... large number of sensor nodes

- Sources of data
- Potentially hundreds or thousands of nodes
- Sensor nodes cooperate to fulfill their tasks

Sensor nodes are deployed in the “environment” (phenomenon to be observed) or close to it

Sensor nodes are resource constraint

- limited in power, computational capacities, memory, ...

Sensor nodes are prone to failures

- e.g., it may not hurt if a node dies if WSN is still operational

Sensor & sensor network: further elements

Actuators

- Control some „in-field device“
- Needed to form control loops and have an impact on the environment

Aggregating nodes

- Process and aggregate data received from several nodes

Sink nodes

- Interested in data from sensor nodes
- Connect WSN to backend systems

Sensor & sensor network: further elements

Backend systems

- for further processing, analysis, ...
- Also for more complex processing, long-term data storage, ...

Networks links between above elements

- Sensor node to sensor node
- Sensor node to sink node
- Sink node to backend
- ...
- Typically different technologies

Examples for WSN structures

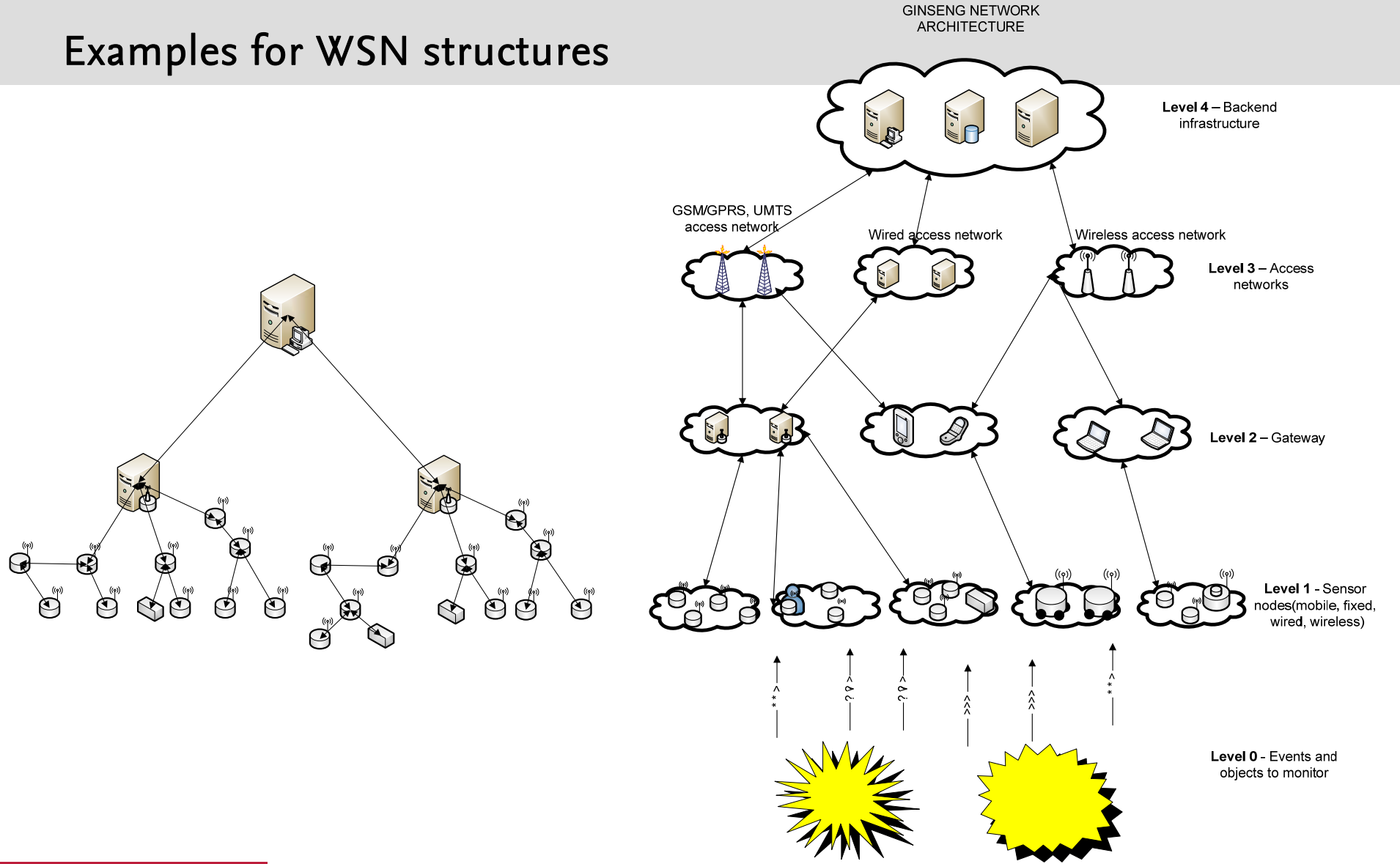

Promising applications for WSNs

Machine and vehicle monitoring

- Sensor nodes in moveable parts
- Monitoring of hub temperatures, fluid levels ...

Health & medicine

- Long-term monitoring of patients with minimal restrictions
- Intensive care with relative great freedom of movement

Intelligent buildings, building monitoring

- Intrusion detection, mechanical stress detection
- Precision HVAC (Heating, Ventilating and Air Conditioning) with individual climate

Environmental monitoring, person tracking

- Monitoring of wildlife and national parks
- Cheap and (almost) invisible person monitoring
- Monitoring waste dumps, demilitarized zones

... and many more: logistics (total asset management, RFID), telematics ...

- WSNs are quite often complimentary to fixed networks!

WSN design considerations / design space

Deployment of nodes and WSN in general

- random vs systematic, manual vs. automatic

Mobility of nodes

- static vs mobile; occasional vs continuous; active vs passive

Node's cost, size, resources

- brick vs matchbox vs grain

Heterogeneity within WSN & among nodes

- homogenous vs heterogeneous wrt type, capabilities, ...
of nodes, tasks, ...

WSN design considerations / design space

Communication approaches

- radio vs light vs ...

Infrastructure

- Infrastructure support used vs completely ad hoc

Network topology

- single-hop vs multihop

Coverage

- sparse vs dense

WSN design considerations / design space

Connectivity

- regularly connected vs intermittent vs sporadic

Network size

- 10 VS 100 VS 1000 VS 10000 VS 100000

Lifetime

- day vs month vs year vs decade

QOS requirements

- none vs real-time

WSN design space: Example network topologies – single- vs. multi-hop

Single-hop (star) topology:

- Direct communication of every sensor node with sink / base station
- Issues:
 - Perhaps large transmission power needed, connectivity, ...

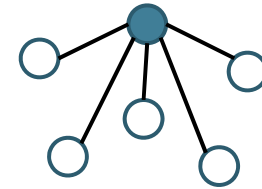

Multi-hop topology

- Some sensors serve as relays
- Issues:
 - Potentially lower transmission power, higher coverage, ...
 - Needs more complex topology control, routing, ...

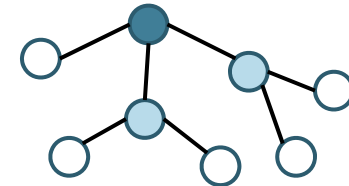

Challenges in Wireless Sensor Networks

Many challenges in WSN, e.g.,

- Energy constraints
- Unreliable communication
- Unreliable sensors
- Deployment
- Scalability, coverage, density
- Limited computation power
- (Re-) Programmability
- Maintainability
- Distributed execution

Challenges in Wireless Sensor Networks: Often not independent

Processing characteristics

- Computation power
- Throughput

Electrical characteristics

- Energy consumption
- Energy dissipation

Physical characteristics

- Shape, ergonomics, robustness
- Dimensions, weight (also of power source)

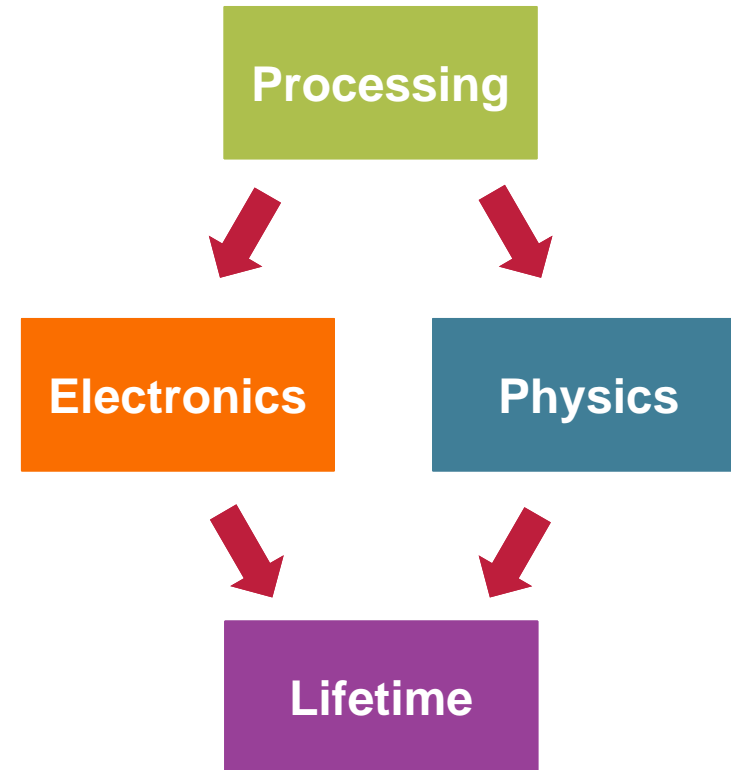

Challenges in WSNs: Energy

How can energy be supplied?

- Batteries
 - How to replace batteries?
- Energy harvesting
 - Light (solar), temperature gradients, motion, vibrations, ...?
- Accept limited life-time of sensor node
 - Necessary lifetime due to mission?

Challenges in WSNs: Energy

Energy consumption:

- ALL parts of sensor node and WSN system are important
 - Node as well as network design
- energy efficiency important within all parts of sensor node & network design
 - Sensing
 - Processing data
 - Storage of data
 - Transmitting data
 - Receiving data

Challenges in WSNs: Energy

To reduce consumption, sensor node

- should only be active if really needed
- sleep otherwise

Typical modes

- controller: Active, idle, sleep
- radio mode: Turn on/off transmitter/receiver, both
- different modes possible, e.g., several sleep modes

Good operational points?

- When to put which part into sleep?
- E.g., from when to when put receiver asleep?

Challenges in WSNs: Deployment & Self-Management

Ways to deploy sensor nodes into their environment:

- Random
 - E.g., dropped from airplanes
- Systematic
 - E.g., installed at specific places to be monitored

- Mobile nodes
 - Active or passive (e.g., wind, water)
 - May compensate for unsettled areas
 - Can move to interesting places

Challenges in WSNs: Deployment & Self-Management

Especially if deployed randomly, sensor node should be able to:

- determine location
- detect neighboring nodes and determine their identity
- configure node parameters
- discover route(s) to base station
- initiate sensing responsibility

Nodes must be prepared for unattended operation

- once deployed, WSN must operate without human intervention
- adapt to changes in topology, density, and traffic load
- adapt in response to failures

(not necessarily also for systematic deployments and more tight controlled scenarios)

Challenges in WSNs: Security

Some WSNs monitor critical infrastructure or carry sensitive infos

→ desirable targets for attacks

Attacks

- from inside / from outside
- target wireless communication / nodes

Difficulties to protect against attacks due to

- remote and unattended operation
- wireless communication
- lack of advanced security features (due to cost, form factor, energy, ...)

Challenges in WSNs: Security

Conventional security techniques

- often not feasible due to their requirements
 - computational, communication, and storage requirements

→ new solutions needed for

- intrusion detection
- encryption
- key establishment and distribution
- node authentication
- ...

WSN compared to MANETs

Commonalities with MANETs

- (typically) self-organization, multi-hop
- Typically wireless, should be energy efficient

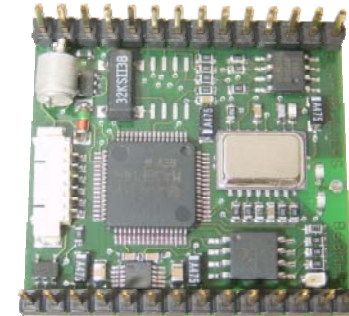

Differences to MANETs

- *Applications:* MANET more powerful, more general ↔ WSN more specific
- *Devices:* MANET more powerful, higher data rates, more resources ↔ WSN rather limited, embedded, interacting with environment
- *Scale:* MANET rather small (some dozen devices) ↔ WSN can be large (thousands)
- *Basic paradigms:* MANET individual node important, ID centric ↔ WSN network important, individual node may be dispensable, data centric
- *Further issues:* Mobility patterns, Quality-of Service, Energy, Cost per node ...

Applications for Wireless Sensor Networks

Many different application areas studied in WSN community, e.g. as shown in the following

- Wildlife Monitoring
- Body Area Networks & Ambient Assisted Living
- Firefighters
- Structural Health Monitoring
- Production processes: GINSENG

Many others exist (not shown here) like

- Traffic control / Management of parking lots
- Volcanoes / mountains / glaciers monitoring
- Agriculture
- Surveillance (civil & military)

Wildlife Monitoring: Rhinopithecus roxellana Monitoring

Real WSN deployment to monitor and track monkeys

- Protected animals
 - No invasive (e.g. RFID) method possible
- Identification by sound
 - Pattern matching to identify individual animals
- Tracking by camera sensors
 - Wake-up camera by change in RSSI

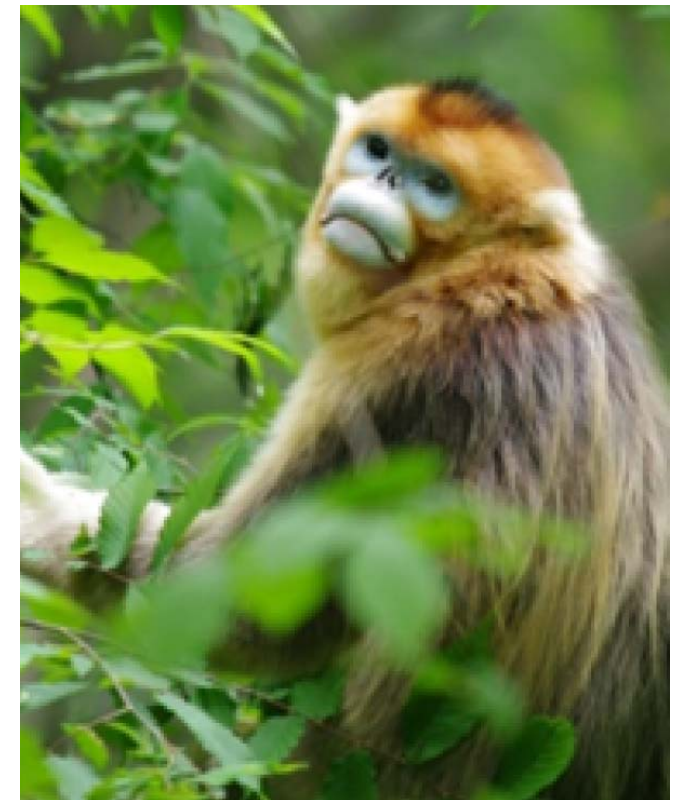

Rhinopithecus roxellana Monitoring – System Architecture

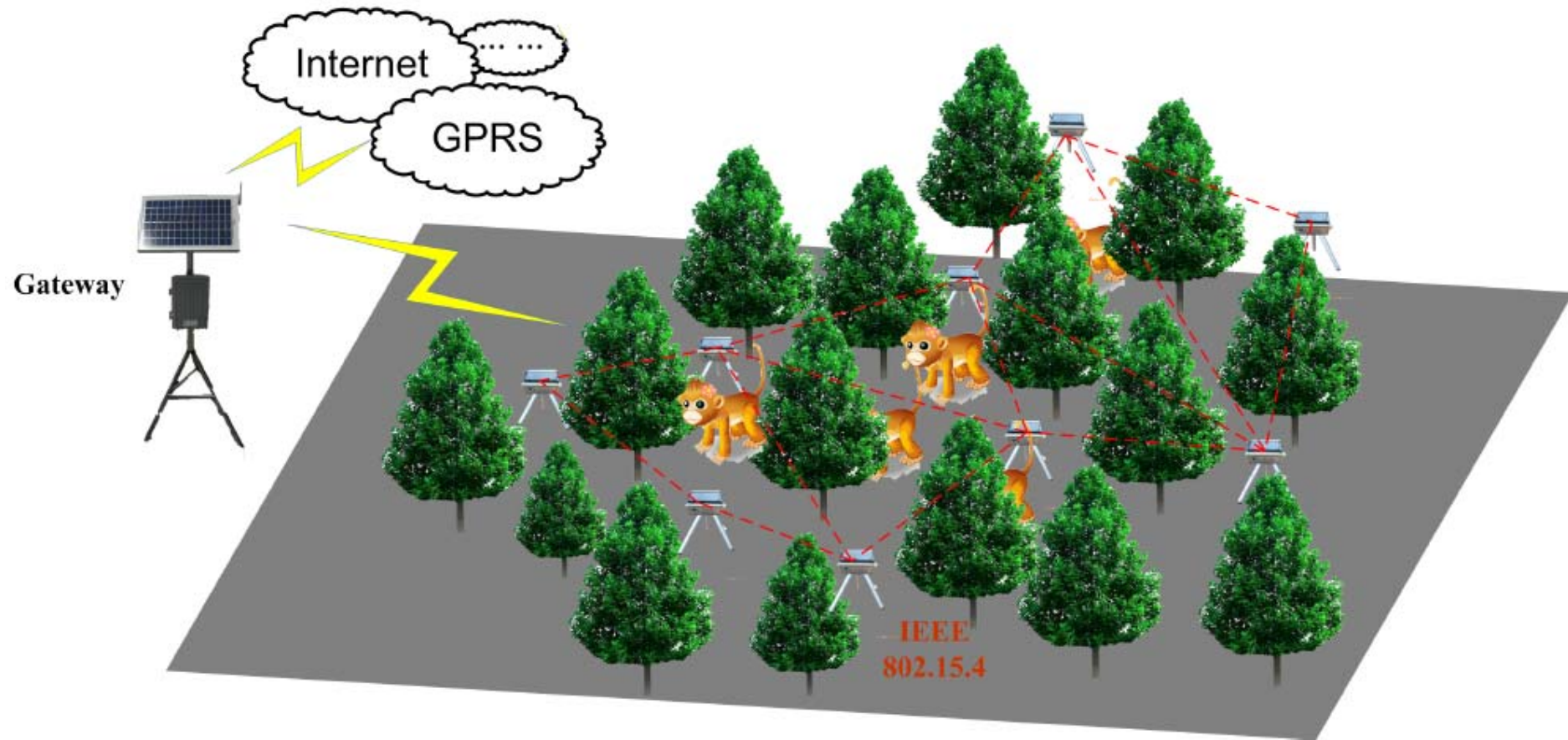

BAN: Body Area Networks

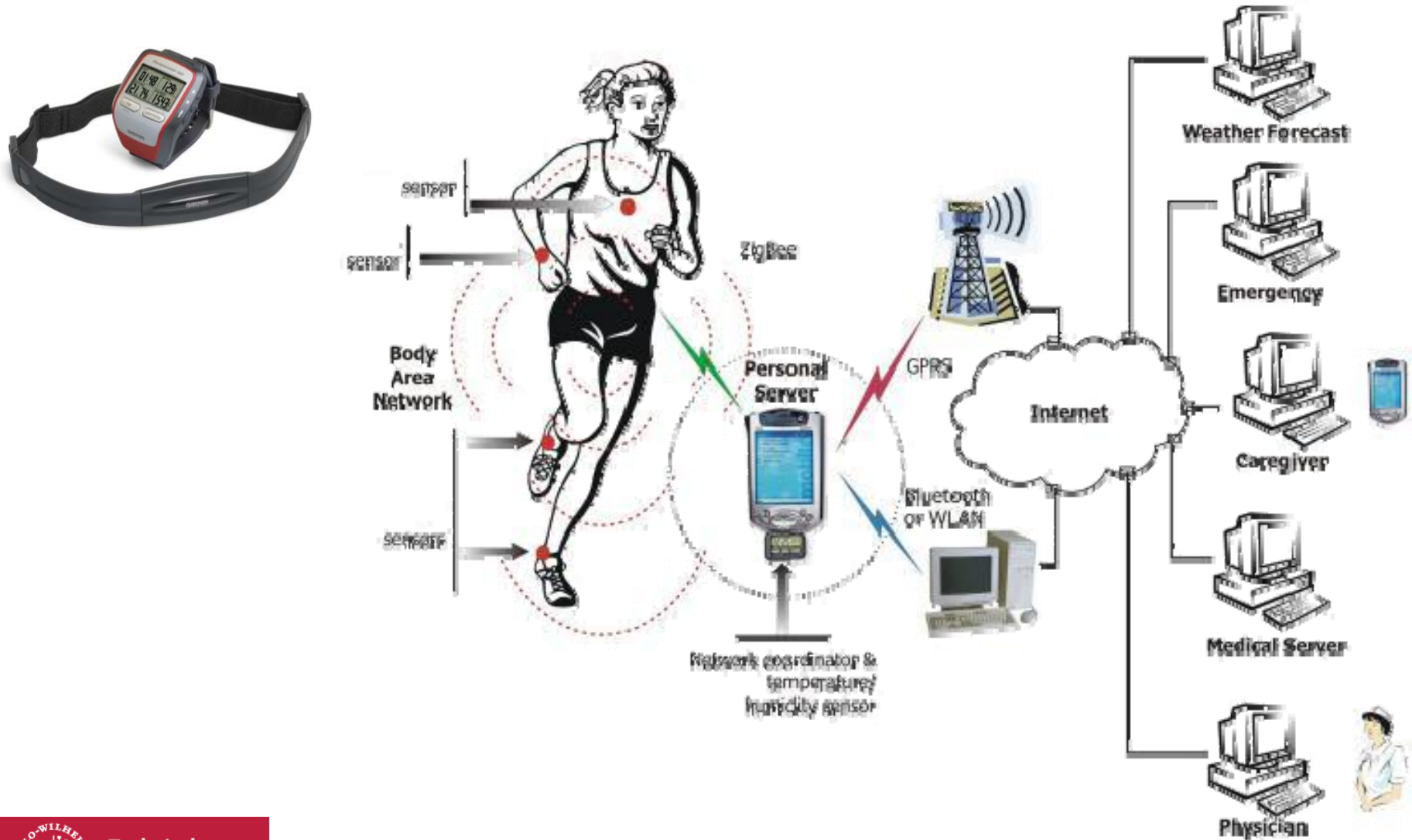

Habitat Monitoring

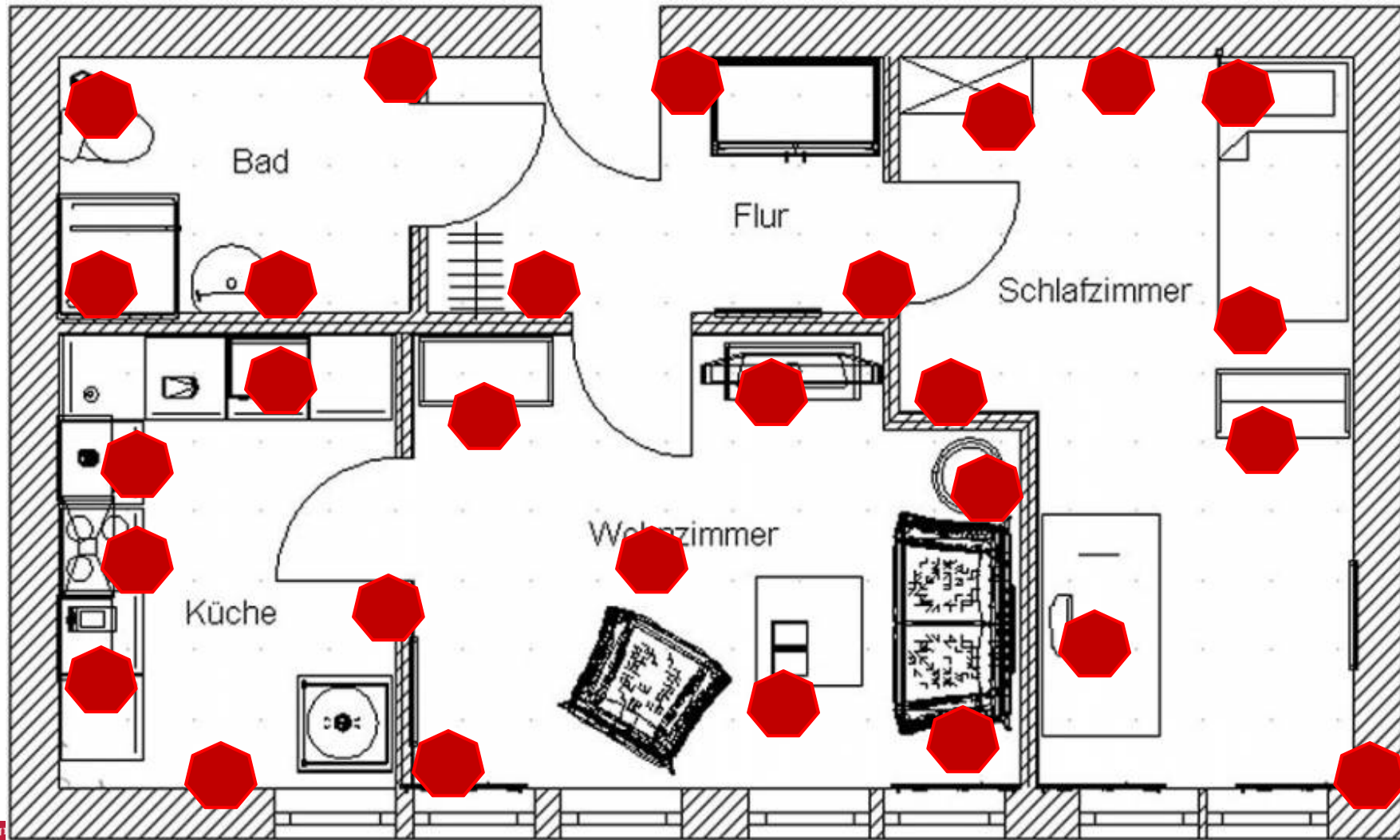

Fire detection with WSNs - Motivation



Moderate surface fire (FWI = 14)



Very intense surface fire (FWI = 24)



Developing active fire (FWI = 34)

FWI – Fire Weather Index

- Depends on temperature & relative humidity
- Measurable with simple and cheap sensors (at least temperature)

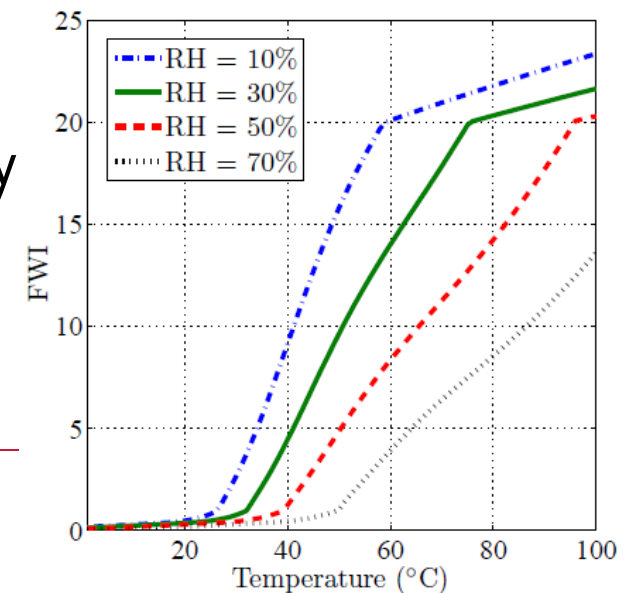

Fire detection with WSNs – System Architecture

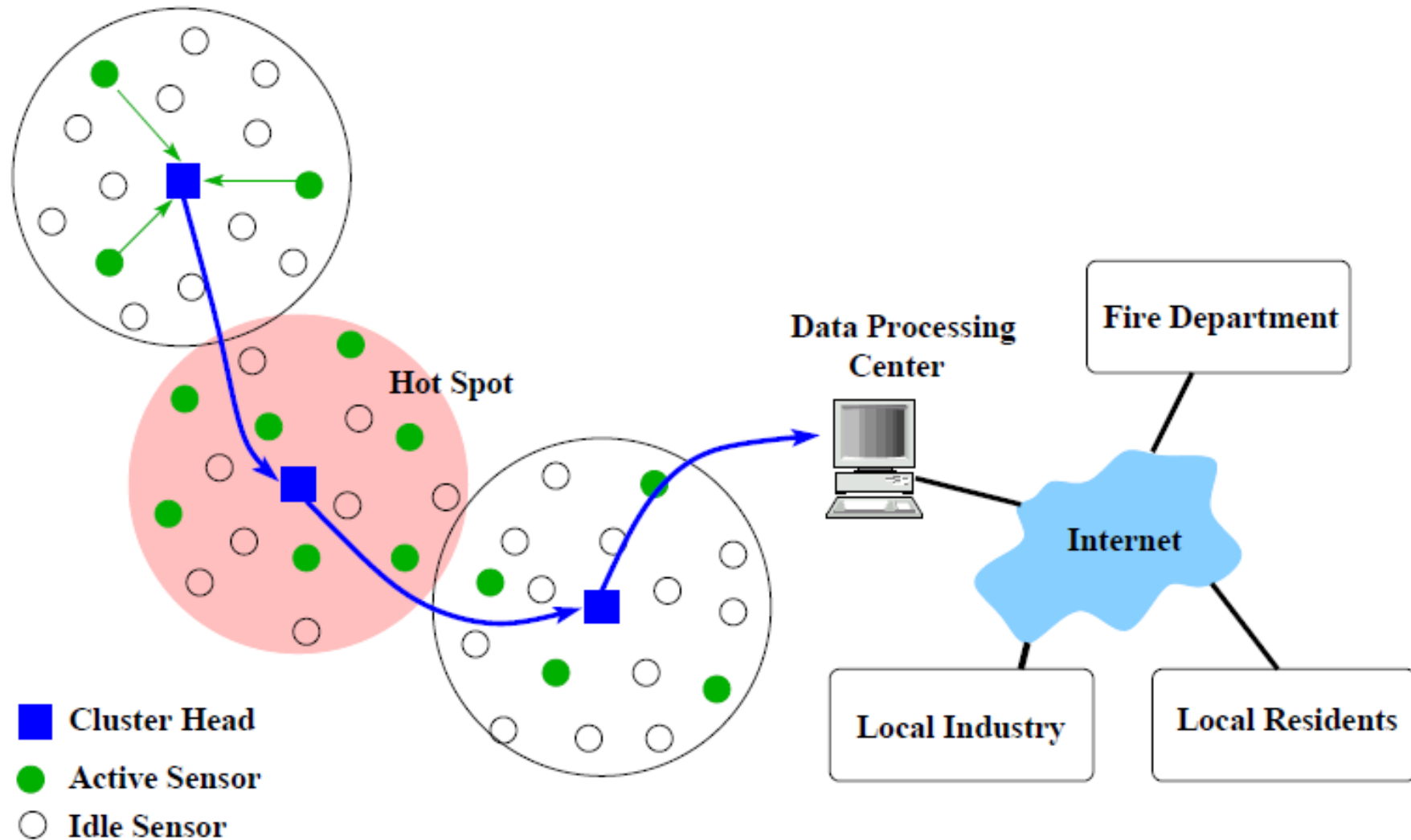

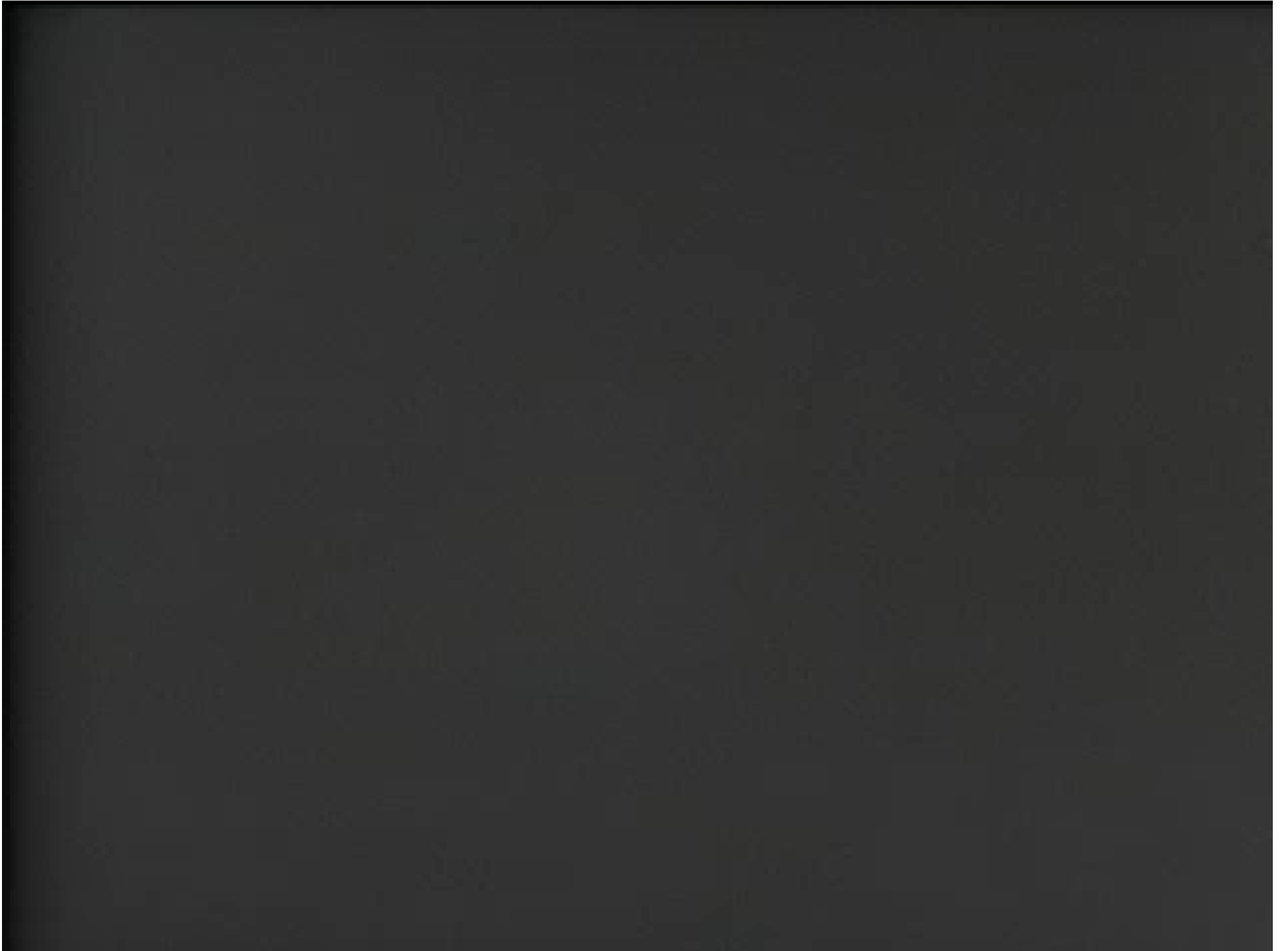

Illinois Structural Health Monitoring Project (ISHMP)

Jindo-gun, South-Korea



2009, Photography by MEMSIC, from <http://blog.memsic.com/2009/11/structural-health-monitoring-part-2-software.html>



Structural Health Monitoring

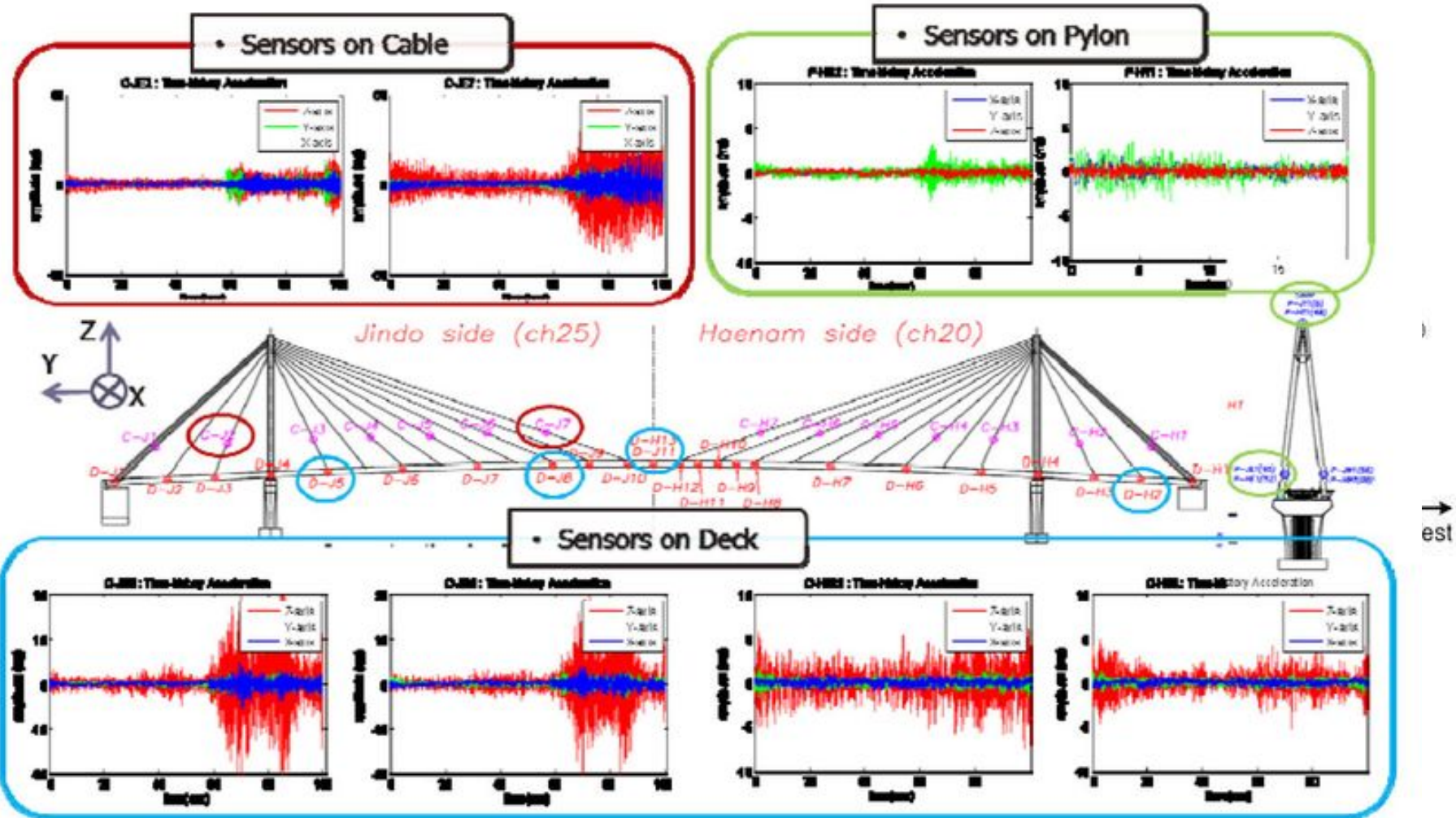

GINSENG



Control of production processes in refinery

- E.g., constant monitoring of pipes
- Close valves before critical condition is reached
- Reduces maintenance effort & production cost
- Improve safety and reduce environment hazards

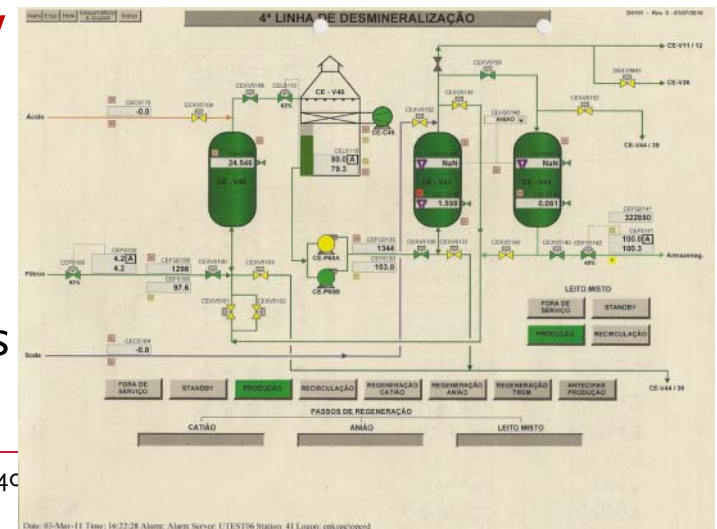

GINSENG

In GALP refinery in Portugal:

- currently approx. 35000 sensors and actuators to perform
 - monitoring of industrial operations such as leakage detection,
 - measurement of pressure in the pipes, fluid levels
 - ...

→ Reduce cost of cabled sensors, but

- guarantee reaction in certain time
- ensure stable operation
- ...

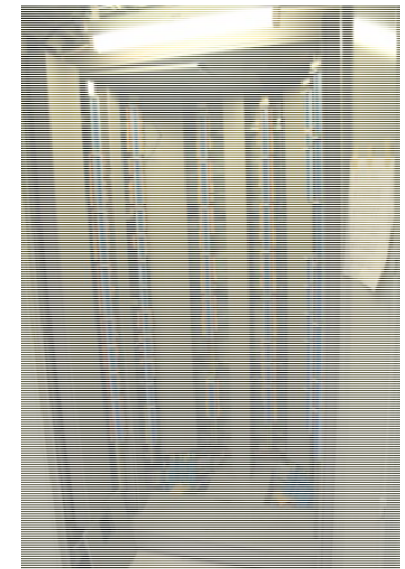
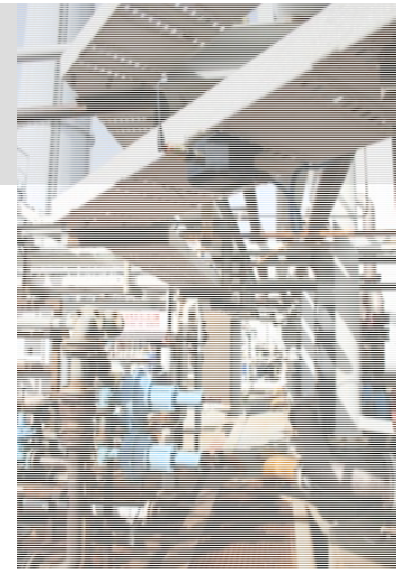

IBR Sensor Floor

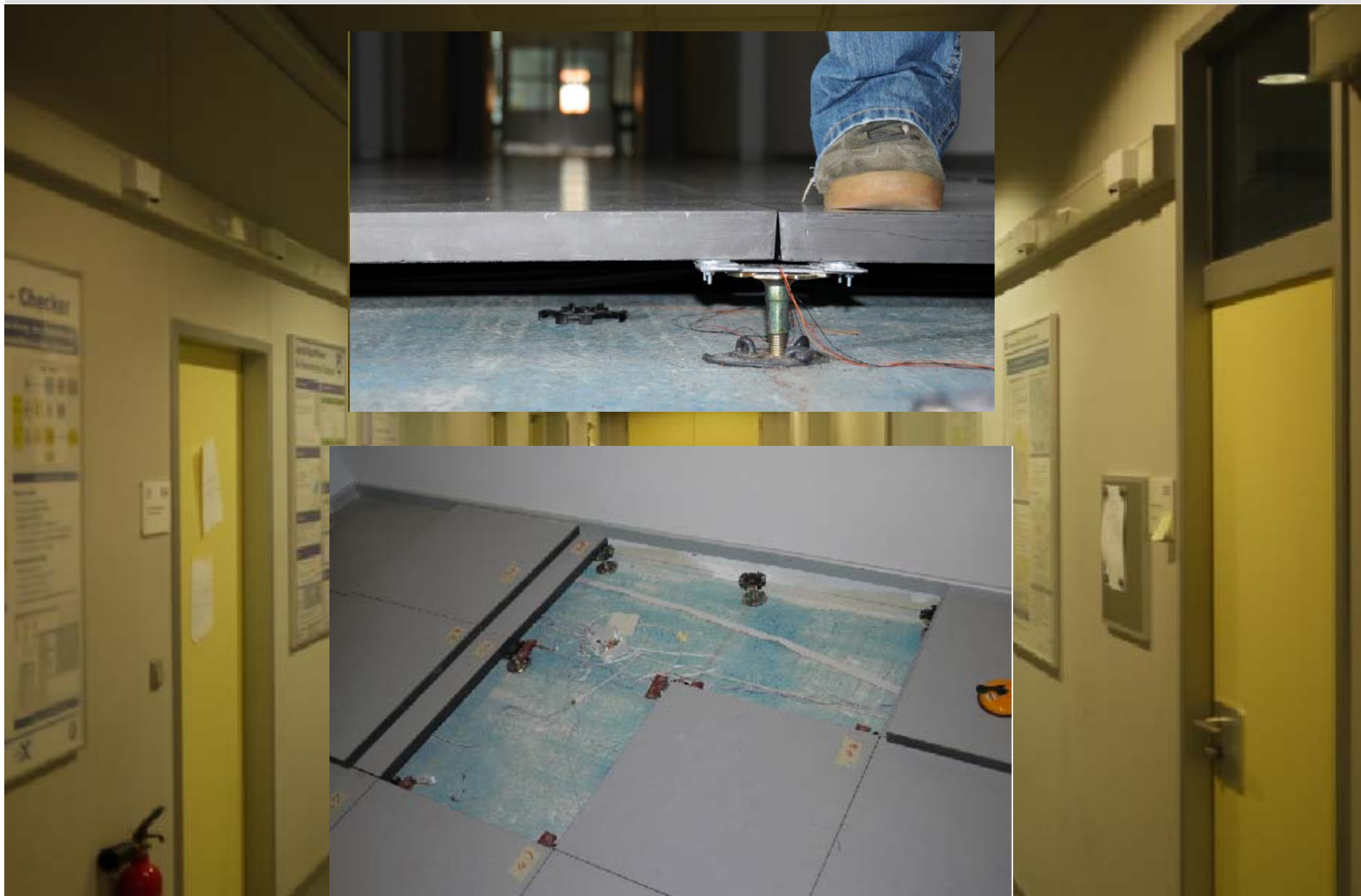

IBR Sensor Floor - Architecture

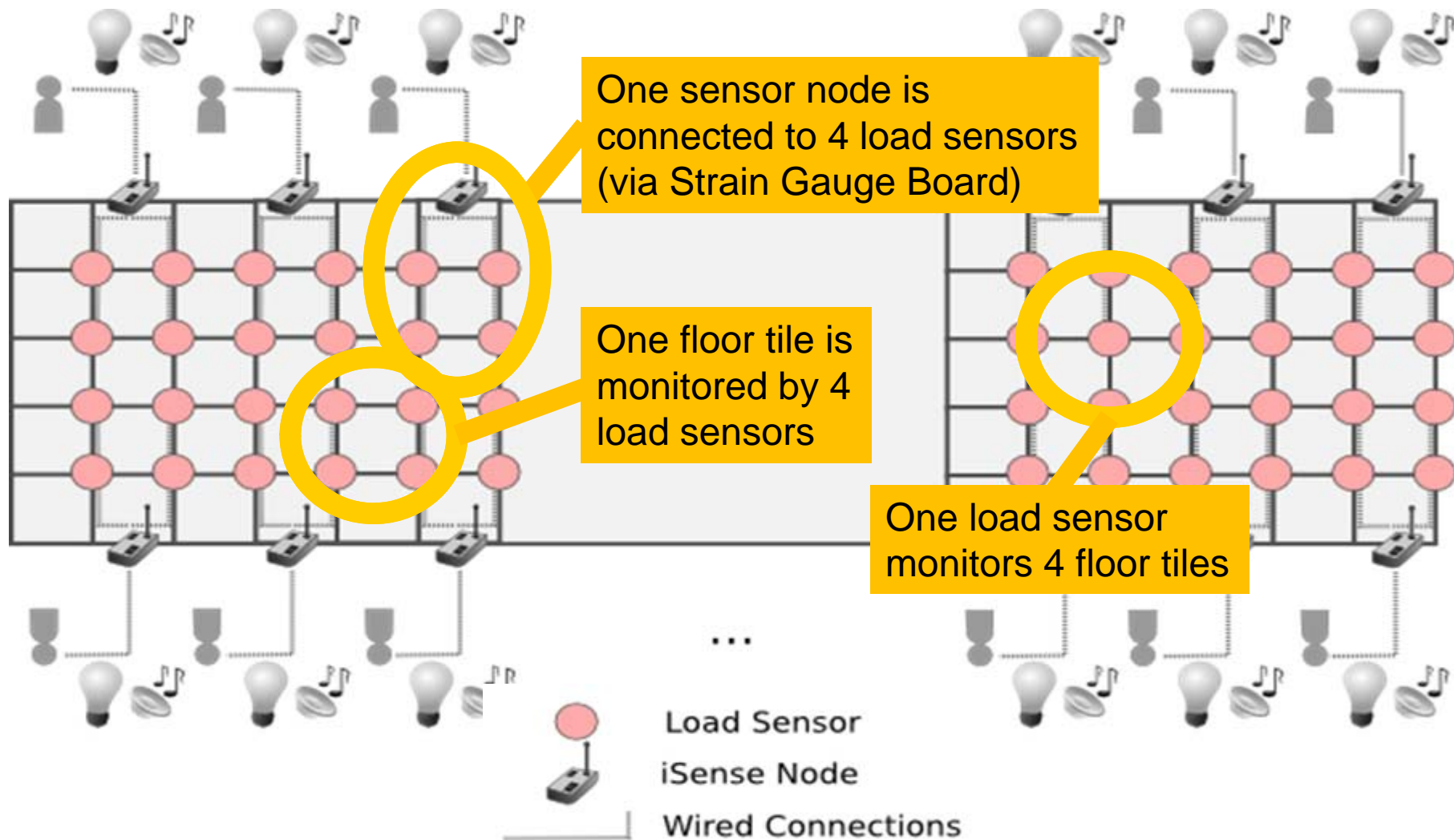

IBR Sensor Floor - Applications

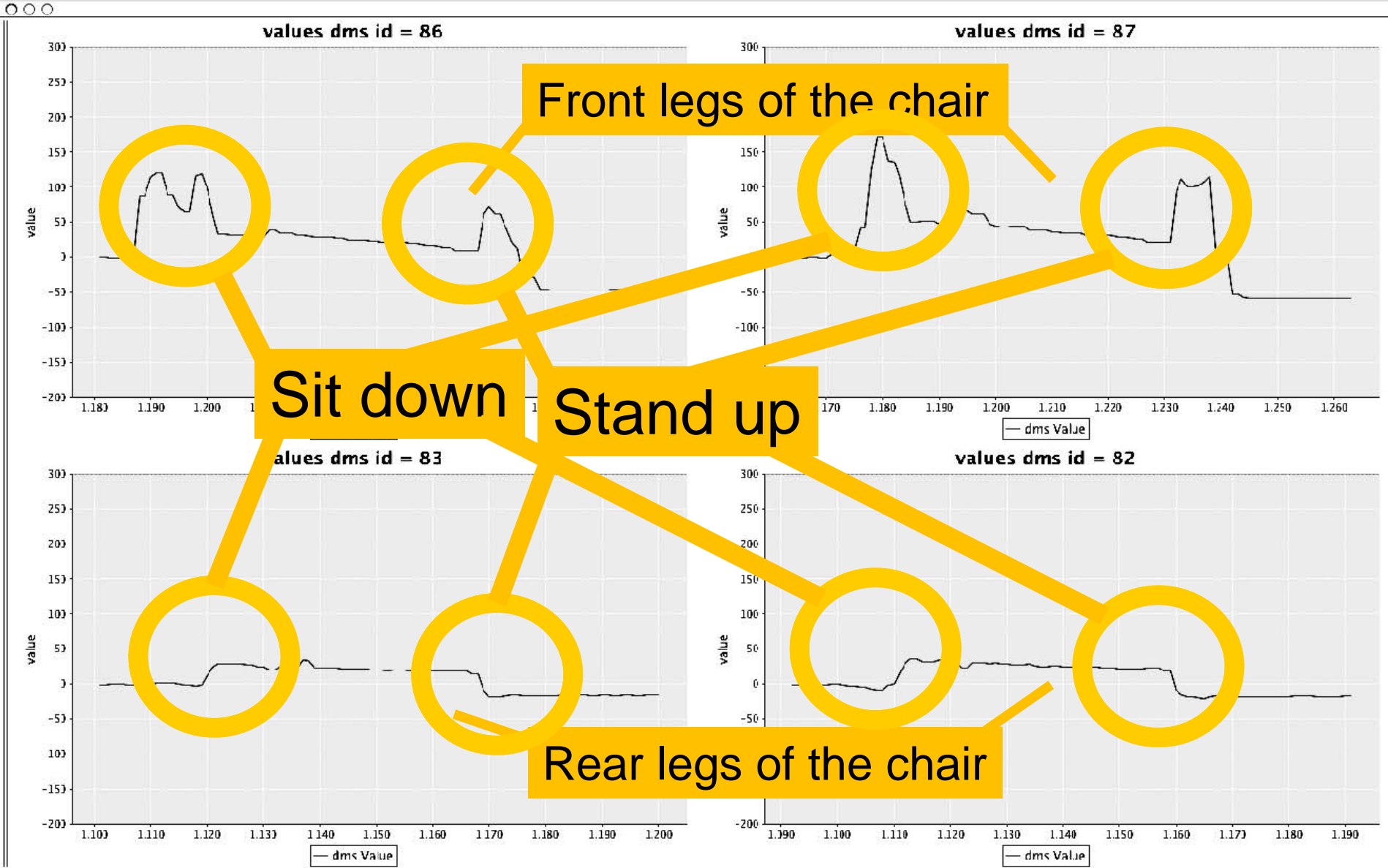

WSN-Applications: some student projects of past & current WSN-lab

- INGA-Sports (Wii-Mote like game controller)
- Sensorfloor-Tennis
- Juggling pins
- Weather stations with data mules
- Monkey Lights Lite
- EASI – Home automation
- ingaRider – bike computer
- Regatta tracing
- Blinkenlights
- Lift monitoring

WSN Applications: Summary

- Different use cases
 - Specific sensor nodes
 - Specific sensors
- Different challenges
 - Energy
 - Size
 - Robustness
 - Network scale
 - Communication ranges
 - ...

➔ Specialized hardware...